

RCD-protected socket outlet 30 mA

2677 ..

RCD 30 mA

2664 ..

GIRA

Gira
Giersiepen GmbH & Co. KG
Electrical installation
systems

Industriegebiet Mermbach
Dahlienstrasse
42477 Radevormwald, Germany

Postfach 12 20
42461 Radevormwald, Germany

Germany

Phone +49(0)21 95 - 602-0
Fax +49(0)21 95 - 602-191

www.gira.de
info@gira.de

10867789 / 08.05.2020

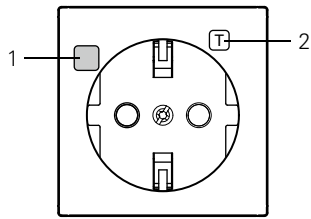

Fig. 1

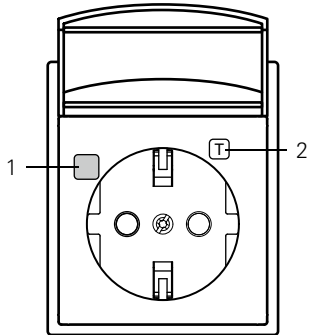

Fig. 2

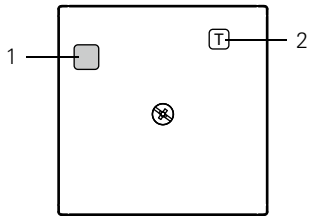

Fig. 3

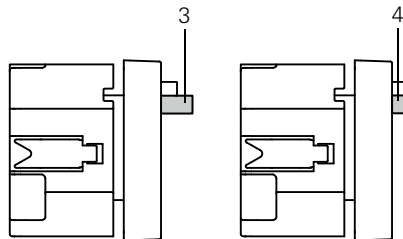

Fig. 4

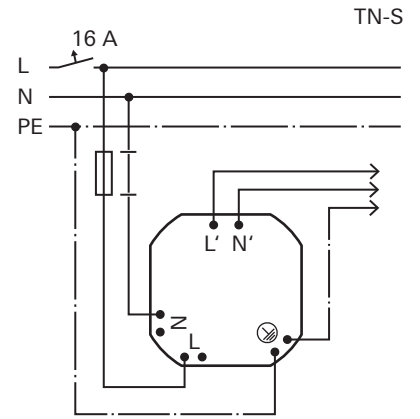

Fig. 5

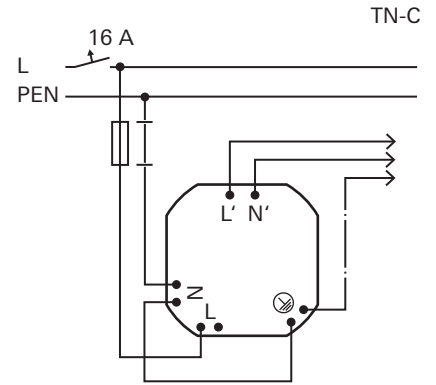

Fig. 6

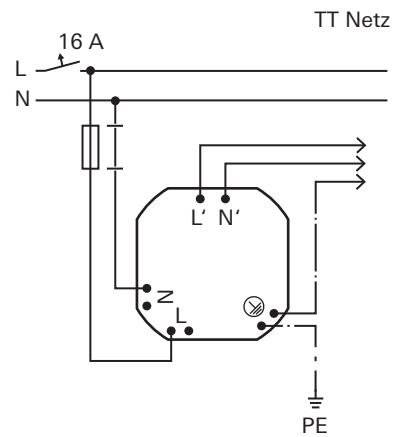

Fig. 7

RCD-protected socket



outlet 30 mA

RCD 30 mA

Safety notes



Electrical devices may only be installed and connected by a qualified electrician.

Failure to observe the instructions can result in damage to the device, fire, or other dangers.

Danger of electric shock. Isolate before working on the device or load. Take account of all circuit breakers supplying dangerous voltage to the device or load.

These instructions are part of the product and must remain with the end customer.

Device design

- RCD-protected socket outlet, fig. 1

- RCD switch, fig. 3

1 Switch

2 Check button T

- Switch position, fig. 4

3 "Off" position

4 "On" position

Function

The functional principle is voltage independent, as for a RCD switch.

The devices RCD-protected socket outlet and RCD are permanently installed protective devices with voltage-dependent residual current tripping acc. to VDE 0664.

Intended use

- Indoor installation in a deep device box acc. to DIN 49073.

- Wallpaper offset max. 1 mm.

Product features

- Residual current protection applies to all devices or cables connected to the RCD-protected socket or the RCD.

- Electrical installations upstream of the RCD-protected socket or switch are not protected.

- Other socket outlets can be connected to the RCD-protected output terminals (L' N').



Note

When connecting other socket outlets to the output terminals (L' / N'), the socket outlets must be installed in the same cover frame as the RCD-protected socket outlets.

Operation

Activating the RCD-protected socket outlet or RCD

- Set switch (1) to position (4) "On".

Device is ready for operation.

Deactivating the RCD-protected socket outlet or RCD

- Set switch (1) to position (3) "Off".

The device has been switched off permanently.

Testing the protective function

Testing the protective function according to applicable regulations.

Mains voltage and socket outlet are switched on.

- Press the test button T (2).

The device switches off immediately. The switch (1) is in position (3) "Off".

- Set switch (1) to position (4) "On".

Device is ready for operation.

The maximum permissible earthing resistances for protection from indirect contact are:

Maximum permissible contact voltage	Maximum permissible earthing resistance at rated leakage current of 30 mA
25 V	833 Ω
50 V	1666 Ω

Mounting and electrical connection



DANGER!

Electric shock if live parts are touched.

Electric shock may lead to death.

Isolate all appropriate circuit breakers before working on the device or load. Cover up live parts in the vicinity!

- Connect the device as required by the application:

Wiring as TN-S circuit (fig. 5), TN-C circuit (fig. 6), or TT circuit (fig. 7).



DANGER!

- Connect other, regular sockets to L', N', and PE.
- Attach device in the device box using claws or the carrier ring (box screws need to be removed completely).
- Switch on mains voltage.
- Test the protective function.

Technical data

Rated voltage: 230 V~
(50 / 60 Hz)

Rated current: 16 A

Rated leakage current: 30 mA

Connection cross sections: 1.5 to 2.5 mm²

Ambient temperature: -25 °C to +40 °C

Warranty

The warranty is provided in accordance with statutory requirements via the retailer.

Please submit or send faulty devices postage paid and with an error description to your sales representative (retailer/installation company). They will forward the devices to the Gira Service Center.