

Issue:
27.11.2023
51923100

Button interface Komfort

Order no. 5192 00, 5194 00, 5198 00

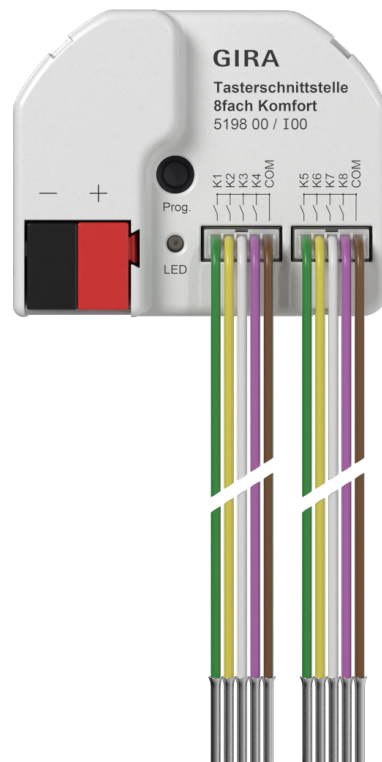

Table of contents

1	Information on the product	4
1.1	Product catalogue	4
1.2	Product characteristics.....	4
1.3	Function	5
1.4	Device components	7
1.5	As-delivered state	9
1.6	Technical data.....	9
1.7	Accessories.....	10
2	Safety instructions	11
3	Mounting and electrical connection	12
4	Commissioning	18
4.1	Safe-state mode.....	18
4.2	Master reset	18
4.3	Restoring the device to factory settings	19
4.4	Firmware update	19
5	Application programs	20
6	Scope of functions	21
7	General settings	26
8	Channel-oriented device functions	31
8.1	Push-button.....	32
8.1.2	Switching	34
8.1.3	Forced position.....	37
8.1.4	Dimming and colour temperature	40
8.1.5	Venetian blind / shutter / awning / roof window	49
8.1.6	Value transmitter	57
8.1.7	Scene extension.....	78
8.1.8	Short and long button actuation	82
8.1.9	Room temperature control point.....	108
8.2	Switch	122
8.2.2	Switching	124
8.2.3	Forced position.....	129
8.2.4	Value transmitter	132
8.2.5	Scene extension.....	151
8.2.6	Room temperature control point.....	156
8.3	Door/window status.....	175

8.4	Leakage/condensation sensor	183
8.5	Temperature sensor.....	186
8.6	Pulse counter	189
8.7	Output	231
8.7.1	Applications	231
9	Channel-independent device functions	240
9.1	Logic functions	241
9.1.1	Logic functions parameters	242
9.1.2	Logic gate.....	244
9.1.3	Converter (1-bit -> 1-byte).....	250
9.1.4	Disabling element (Filtering/Time).....	254
9.1.5	Comparator	261
9.1.6	Limit value switch	271

1 Information on the product

1.1 Product catalogue

Product name Button interface, 2-gang Komfort

Order no. 5192 00

Use Interface

Design FM (flush-mounted)

Product name Button interface, 4-gang Komfort

Order no. 5194 00

Use Interface

Design FM (flush-mounted)

Product name Button interface, 8-gang Komfort

Order no. 5198 00

Use Interface

Design FM (flush-mounted)

1.2 Product characteristics

- Depending on the variant, two, four or eight independent channels, which work as inputs or as outputs, depending on the ETS configuration
- Common reference potential for all channels
- Disabling of individual channels
- Supply via the KNX bus, no additional supply voltage necessary

Inputs

- Connection of potential-free contacts, such as push-buttons, switches or Reed contacts
- Impulse current for avoiding contact fouling (image of an oxide layer) at the connected contacts
- Operating functions: switching, dimming, controlling of venetian blinds, moods or room temperature
- Value transmitter for dimming, colour temperature, RGBW, temperature and brightness values
- Transmission of the current input state after bus voltage failure
- Connection of door or window contacts for the evaluation of the status open, closed, tilted and grip position
- Connection of leakage, condensation and temperature sensors (see accessories)
- Pulse counter with main counter and intermediate counter

- Combination of adjacent input channels for the push-button and door/window status channel functions
- Logic functions

Outputs

- Connection of LEDs
- Short-circuit resistant, overload-protected and reverse-polarity protected
- Switching outputs in parallel possible, for loads with higher energy consumption

1.3 Function

General

The device is compatible with KNX Data Secure products. KNX Data Secure offers protection against manipulation in building automation and can be configured in the ETS project. Detailed technical knowledge is required. A device certificate, which is attached to the device, is required for safe commissioning. During mounting, it is recommended to remove the certificate from the device and to store it securely.

The device can be updated. Firmware can be easily updated with the Gira ETS Service App (additional software).

Function

The push-button interface has up to 8 independent channels. Each channel can be used as an input or output. The push-button interface can read in up to 8 contact states without potential via its inputs in event of a shared reference potential and transmit telegrams on the bus accordingly.

With the push-button connected, telegrams for switching, forced position, dimming the brightness or colour temperature, shading control, transmitting values, calling up or switching a scene as scene extension or operating a room temperature controller with the room temperature control point can be transmitted on the bus in the "push-button" channel function. Optionally, different telegrams can be transmitted on the bus by pressing the button briefly or for a long time. The contact type of the push-buttons can be parameterised in the process.

- i** The "push-button" channel function is recommended if telegrams are to be transmitted on the KNX, depending on how long the channel/push-button was actuated. For example in the "dimming", "venetian blind", "value transmitter with value adjustment", "telegram upon short or long button actuation" functions or with the "RGB(W) colour adjustment".

With the switch connected, telegrams for switching, forced position, transmitting values, calling up or switching a scene as scene extension or operating a room temperature controller with the room temperature control point can be transmitted on the bus by means of one or two objects in the "switch" channel function. One value can be parameterised when closing and one value when opening the contact.

- i** The "switch" channel function is recommended if telegrams are to be transmitted cyclically on the KNX. This allows monitoring, similar to the heartbeat, to be implemented or rising and falling edges - like with the switch - to be evaluated regardless of the time.

With the door or window contacts connected, different window or door states can be evaluated and corresponding telegrams transmitted on the bus in the "door/window status" channel function.

With the leakage or condensation sensor connected, the leakage or condensation status can be evaluated and corresponding telegrams transmitted on the bus in the "leakage/condensation sensor" channel function.

In the "pulse meter" channel function, the channel counts the number of pulses at the input. The "pulse meter" channel function includes the evaluation of a main meter and intermediate meter.

- i** For channels 1 and 2 only: With the temperature sensor connected, the temperature can be evaluated and corresponding telegrams transmitted on the bus in the "temperature sensor" channel function. Optionally, the temperature measurement of the connected sensor can be supplemented by an external temperature value via the bus.

In the "output" channel function, the channels, as independent outputs, can actuate consumers, e. g. the corresponding LED (see chapter "(siehe technische Daten)" ▶ Page 9). To increase the output current, these channels can also be switched in parallel to each other with the same parameterisation. The outputs are short-circuit resistant, overload-protected and reverse-polarity protected.

- i** The connection of 230 V signals or other external voltages to the inputs is not permitted!

1.4 Device components

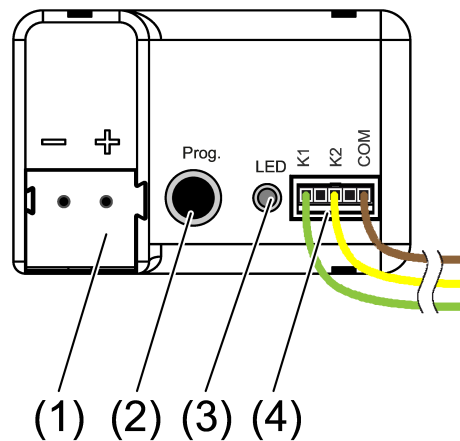

Figure 1: "2-gang" device variant

- (1) KNX connection
- (2) Programming button
- (3) Programming LED
- (4) Connecting cable

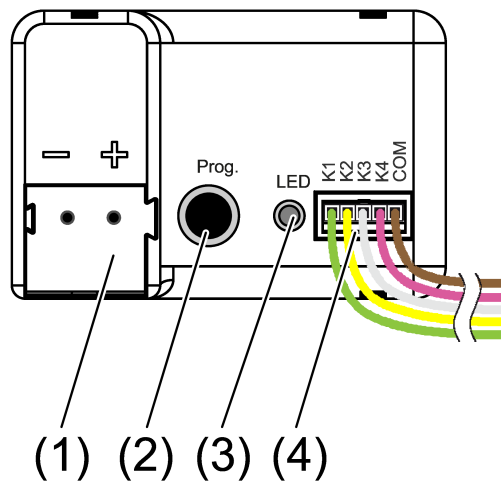

Figure 2: "4-gang" device variant

- (1) KNX connection
- (2) Programming button
- (3) Programming LED
- (4) Connecting cable

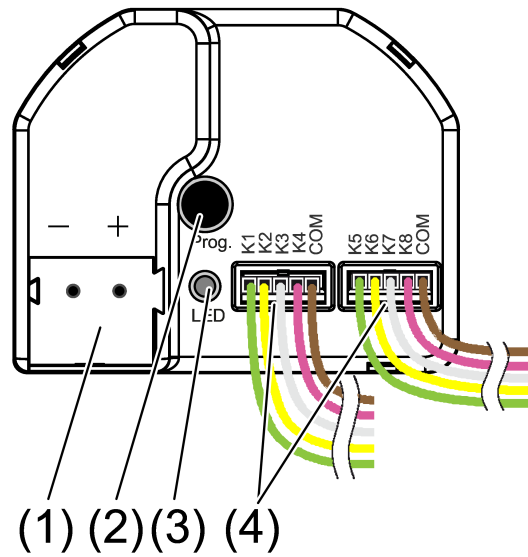

Figure 3: "8-gang" device variant

- (1) KNX connection
- (2) Programming button
- (3) Programming LED
- (4) Connection cables

1.5 As-delivered state

The device is not functional when delivered. The device does not transmit any telegrams on the bus.

1.6 Technical data

Ambient temperature	-5 ... +45°C
Storage/transport temperature	-25 ... +75°C
Degree of protection	IP20
Protection class	III
Number of channels	
5192 00	2
5194 00	4
5198 00	8
Output voltage	
5192 00, 5194 00, 5198 00	DC 5 V SELV
Output current per channel	
5192 00, 5194 00, 5198 00	max. 3.2 mA
LED current (red LED with 1.7 V current voltage)	
5192 00, 5194 00, 5198 00	2.2 mA per output
Connection of channels	
5192 00	3-core wiring harness
5194 00	5-core wiring harness
5198 00	2x 5-core wiring harness
Length, wiring harness	
5192 00, 5194 00, 5198 00	25 cm, can be extended to max. 30 m
Recommended cable	J-Y(St)Y 2×2×0.8
Dimensions (LxWxH)	
5192 00, 5194 00	43.0 x 28.5 x 15.4 mm
5198 00	43.5 x 35.5 x 15.4 mm
KNX medium	TP256
Commissioning mode	S mode
Rated voltage KNX	DC 21 ... 32 V SELV
Connection mode KNX	Device connection terminal
Current consumption KNX	
5192 00	5 ... 10 mA
5194 00	5 ... 12 mA
5198 00	5 ... 18 mA

1.7 Accessories

Remote sensor	Order no. 1493 00
Leakage sensor	Order no. 5068 00
Condensation sensor	Order no. 5069 00

2 Safety instructions

To avoid potential damage, read and follow the following instructions:



Electrical devices may be mounted and connected only by electrically skilled persons.

Danger of electric shock. During installation and cable routing, comply with the regulations and standards which apply for SELV circuits.

Danger of electric shock. Make sure during the installation that there is always sufficient insulation between the mains voltage and the bus. A minimum distance of at least 4 mm must be maintained between bus conductors and mains voltage cores.

Danger of electric shock on the installation. Do not connect any external voltage to the inputs. The device might be damaged, and the SELV potential on the bus line will no longer be available.

This manual is an integral part of the product, and must remain with the customer.

3 Mounting and electrical connection

Mount device

In secure operation (preconditions):

- Secure commissioning is activated in the ETS.
- Device certificate entered/scanned or added to the ETS project. A high resolution camera should be used to scan the QR code.
- Document all passwords and keep them safe.
- In secure operation: device certificate must be removed from the device and stored securely.
- Mounting in suitable appliance box. Observe cable routing and spacing

Bus connection

- Connect a bus with a KNX device connection terminal to the KNX connector (1).

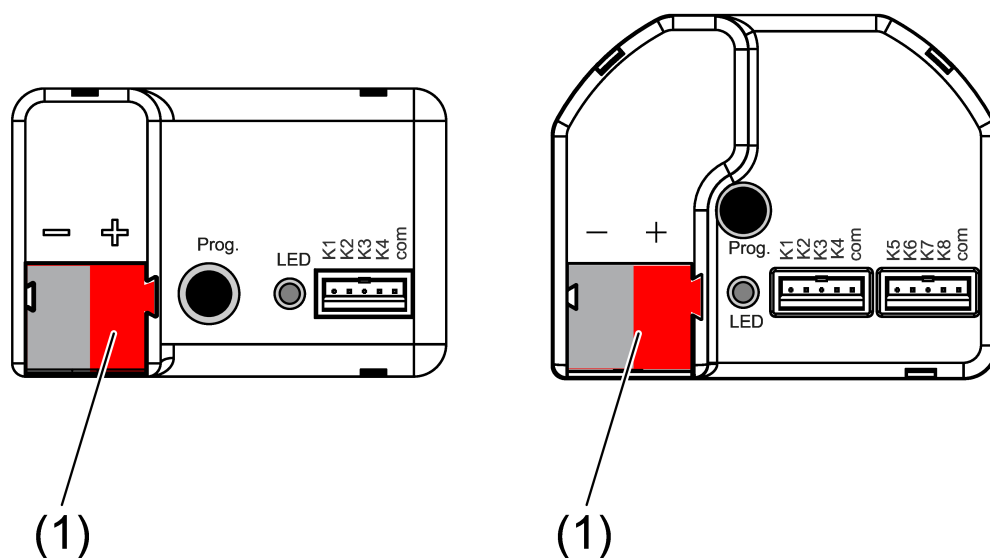

Figure 4: Bus connection

- (1) KNX connection

Installation instructions

- To avoid interference from EMC radiation, the cables of the inputs should not run parallel to cables carrying mains voltage or to load cables.
- The voltage potentials of the connecting cables for the inputs and outputs are not galvanically isolated from the bus voltage. The connecting cables actually lengthen the bus cable. The specification for the bus cable length (max. 1000 m) must be observed.
- Do not connect the **COM** connections of multiple push-button interfaces.
- Use channels 1 and 2 for NTC temperature sensors (see chapter "Accessories" ▶ Page 10).

- No series resistance is required to connect suitable LEDs (see chapter "Technical data" ▶ Page 9).

When extending the supplied cable sets (see figure 5), observe the maximum cable length l : max. 30 m. The COM cable for each cable set must not exceed the total maximum length of l .

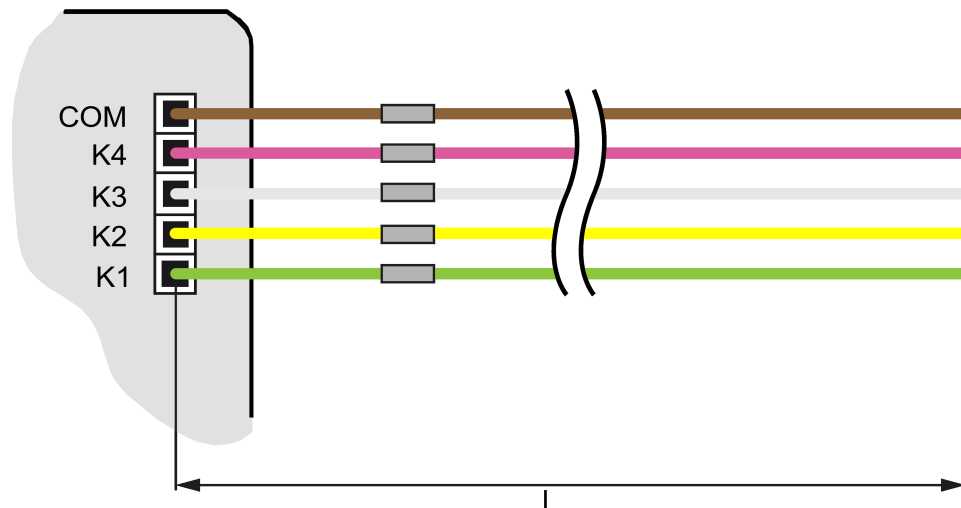

Figure 5: Maximum cable length



DANGER!

Danger of electrical shock when mains voltage 230 V or other external voltages are connected!

Electric shocks can be fatal.

Device may be destroyed.

Only connect potential-free push-buttons, switches or contacts.

- Connect push-buttons, switches, contacts, LED or NTC to enclosed connecting cables (4) according to the connection examples; (see figure 6) to (see figure 9). The connection examples show the use with inputs and outputs.

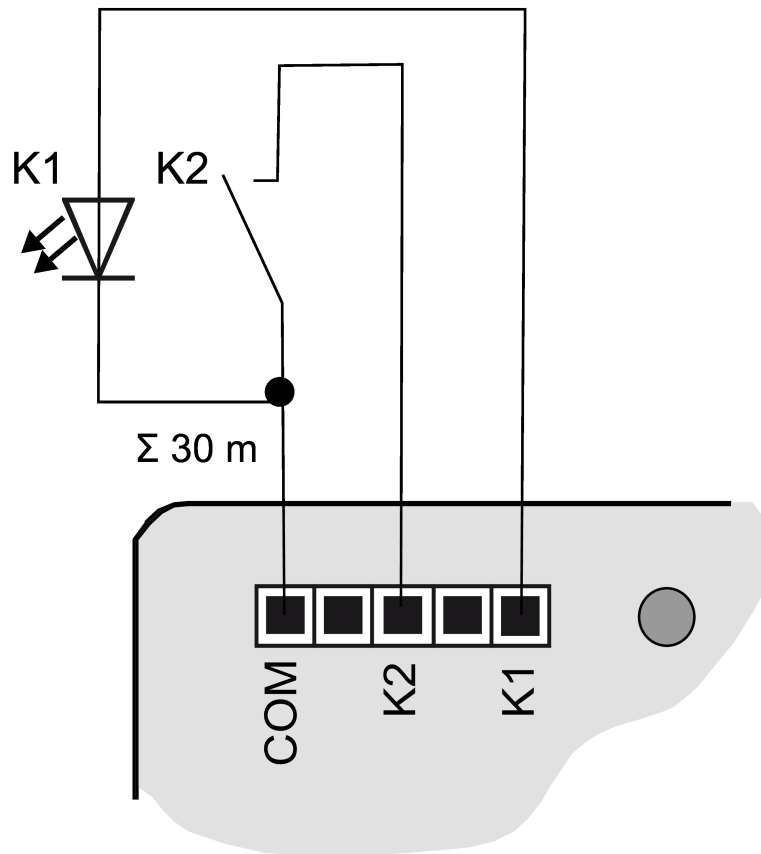

Figure 6: Connection example: push-button interface 2-gang

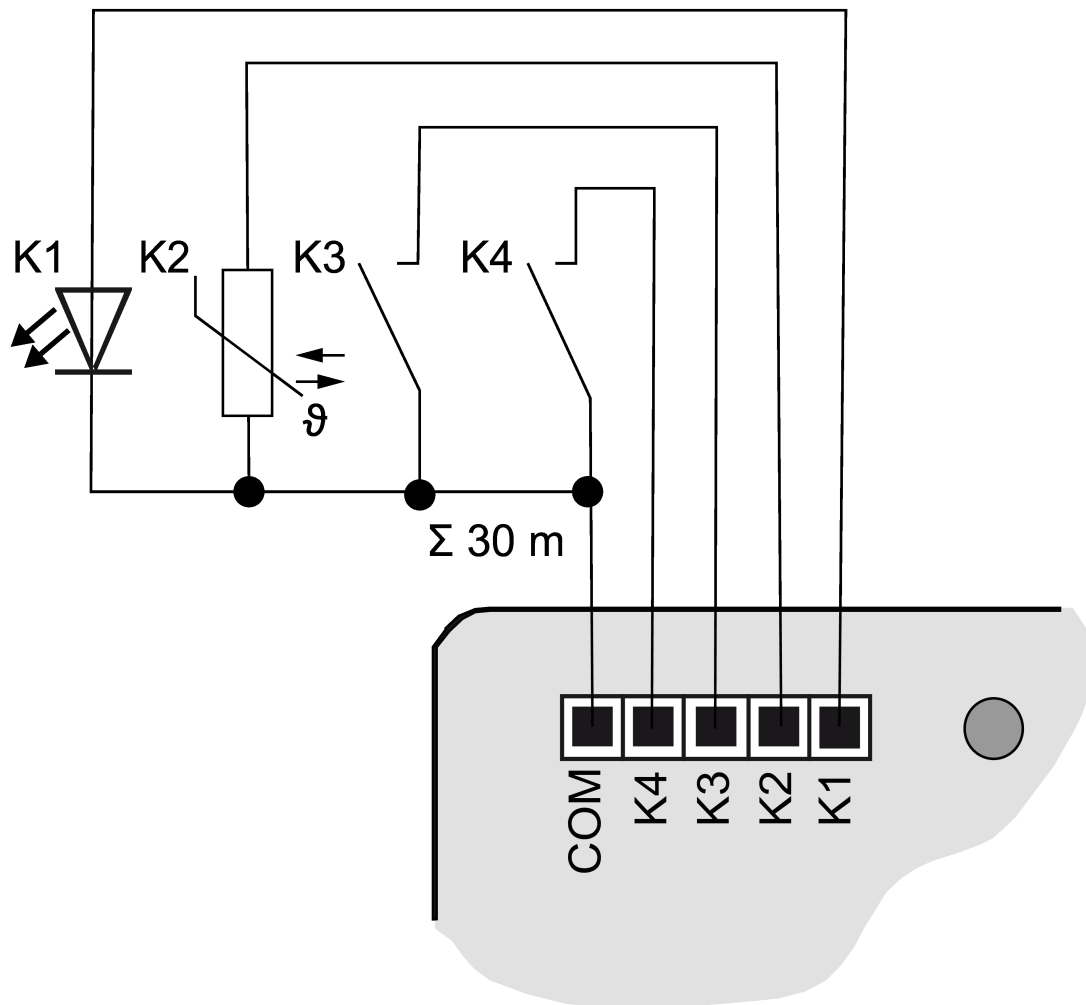

Figure 7: Connection example: push-button interface 4-gang

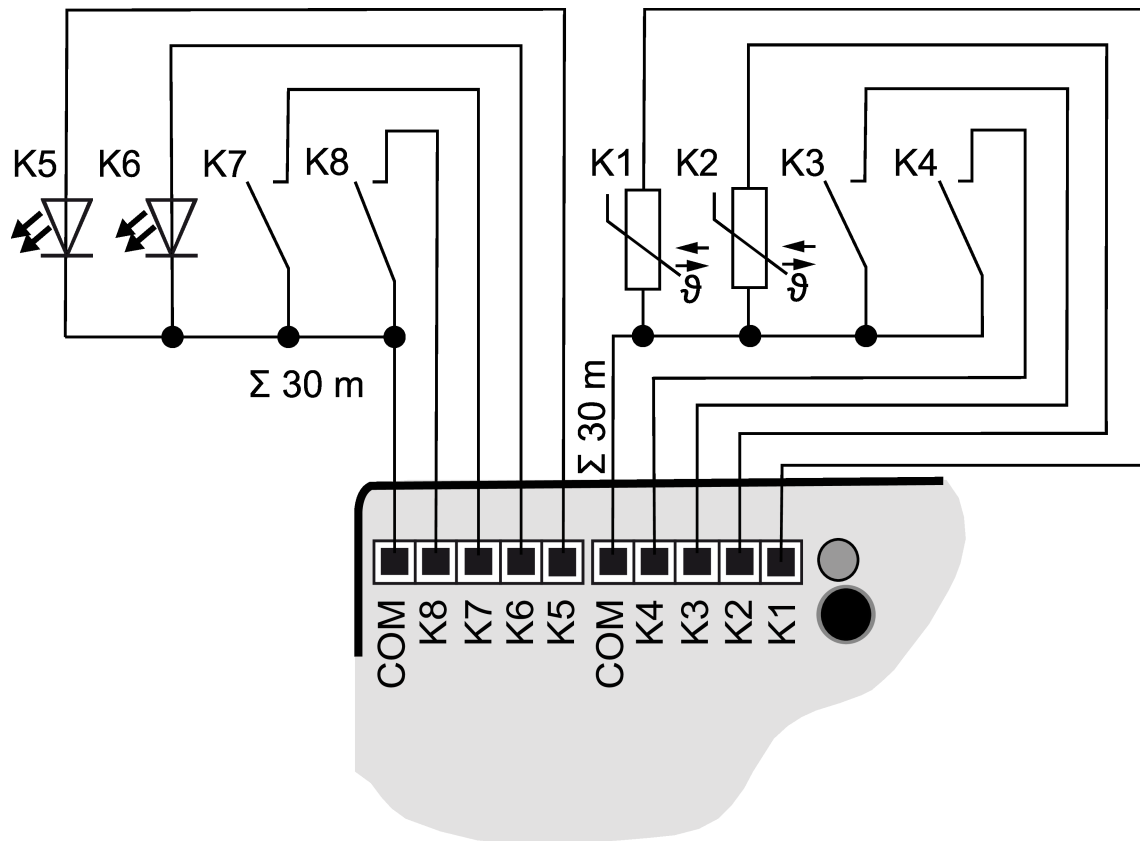

Figure 8: Connection example: push-button interface 8-gang

- i** To increase the output current, outputs can also be switched parallel to each other with the same parameterization; in the example here, (see figure 9) **K1-K3** are switched in parallel.

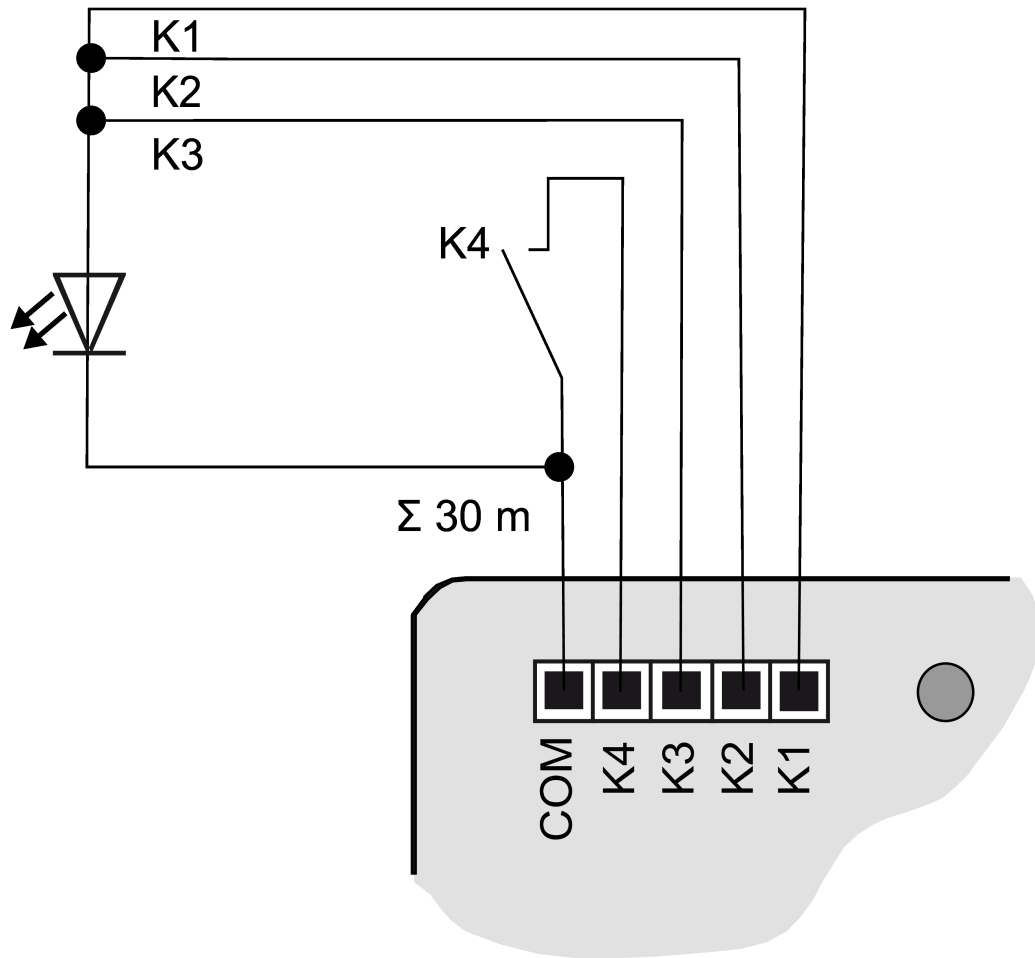

Figure 9: Connection example with outputs switched in parallel

4 Commissioning

Programming the physical address and application program

- Switch on the bus voltage.
- Press the programming button (2).
The programming LED (3) lights up.
- Program the physical address with the ETS.
The programming LED goes out.
- Program the application program with the ETS.

4.1 Safe-state mode

The safe-state mode stops the execution of the loaded application program.

- i** Only the system software of the device is still functional. ETS diagnosis functions and programming of the device are possible.

Activating safe-state mode

- Switch off the bus voltage or remove the KNX device connection terminal.
- Wait approx. 10 seconds.
- Press and hold down the programming button.
- Switch on the bus voltage or attach the KNX device connection terminal.
- Wait until the programming LED flashes slowly.
- Release the programming button.

The safe-state mode is activated.

By briefly pressing the programming button again, the programming mode can also be switched on and off in the safe-state mode as usual. If the programming mode is active, the programming LED stops flashing.

Deactivating safe-state mode

- Switch off bus voltage (wait approx. 10 seconds) or carry out ETS programming.

4.2 Master reset

The master reset restores the basic device settings (physical address 15.15.255, firmware remains in place). The device must then be recommissioned with the ETS.

In secure operation: A master reset deactivates device security. The device can then be recommissioned with the device certificate.

Performing a master reset

Precondition: The safe-state mode is activated.

- Press and hold down the programming button for > 5 s.
The programming LED flashes quickly.
- Release the programming button.
The device performs a master reset, restarts and is ready for operation again after approx. 5 s.

4.3 Restoring the device to factory settings

The device can be reset to factory settings with the Gira ETS Service App. This function uses the firmware contained in the device that was active at the time of delivery (delivered state). Restoring the factory settings causes the device to lose its physical address and configuration.

4.4 Firmware update

The device can be updated. Firmware can be easily updated with the Gira ETS Service App (additional software).

5 Application programs

ETS search paths: - Input / binary input, 2-gang / Button interface, 2-gang Komfort
 - Input / binary input, 4-gang / Button interface, 4-gang Komfort
 - Input / binary input, 8-gang / Button interface, 8-gang Komfort

Configuration: S-mode standard

Application program available for Button interface, 2-gang Komfort

Name Button interface, 2-gang Komfort 707221
 Version 2.1 for ETS from version 5.7.7 or 6.1.0
 from mask version 07B0
 Summarized de- Multifunctional ETS application for the Button interface, 2-gang
 scription Komfort.
 The ETS application supports KNX Data Secure.
 Each channel can be parameterised for different application cases. Optionally, logic functions can be configured.

Application program available for Button interface, 4-gang Komfort

Name Button interface, 4-gang Komfort 707421
 Version 2.1 for ETS from version 5.7.7 or 6.1.0
 from mask version 07B0
 Summarized de- Multifunctional ETS application for the Button interface, 4-gang
 scription Komfort.
 The ETS application supports KNX Data Secure.
 Each channel can be parameterised for different application cases. Optionally, logic functions can be configured.

Application program available for Button interface, 8-gang Komfort

Name Button interface, 8-gang Komfort 707821
 Version 2.1 for ETS from version 5.7.7 or 6.1.0
 from mask version 07B0
 Summarized de- Multifunctional ETS application for the Button interface, 8-gang
 scription Komfort.
 The ETS application supports KNX Data Secure.
 Each channel can be parameterised for different application cases. Optionally, logic functions can be configured.

6 Scope of functions

General

- KNX Data Secure capable
- Firmware updates are possible

Channel configuration

- Channels can be activated and deactivated individually
- Adjacent, activated channels can be combined (e. g. K1 + K2)

"Push-button" channel function

- i** The "push-button" channel function is recommended if telegrams are to be transmitted on the KNX, depending on how long the channel/push-button was actuated. For example in the "dimming", "venetian blind", "value transmitter with value adjustment", "telegram upon short or long button actuation" functions or with the "RGB(W) colour adjustment".
- i** Available for a single channel and in the combined configuration.
- i** The combined configuration is recommended, for example, for 'dimming' or 'moving the venetian blind' with a connected series push-button. In this way, it is possible to use one button to dim or move up and the other button to dim or move down.
 - The contact type can be set
 - The function of the push-button can be set...

Switching

The command when pressing and/or releasing can be set (no reaction, switch on, switch off, toggle).

Forced position

The command when pressing and/or releasing can be set (no reaction; forcing active, switch on; forcing active, switch off; forcing inactive).

Dimming and colour temperature

The command when pressing the button, the time between switching and dimming, the dimming at different levels, the telegram repetition in the event of long actuation and the transmission of a stop telegram at the end of actuation can be set.

Venetian blind / shutter / awning / roof window

The command when pressing the button and the command sequence can be set.

Value transmitter

The data point type | value range and the value can be set. The value adjustment can optionally be activated by long button-actuation.

Scene extension

The scene number can be called up or switched over by briefly pressing the button. Optionally, the storage function is executed by pressing the button longer.

Short and long button actuation

Up to two telegrams can be transmitted on the KNX by pressing the button. The transmission behaviour can be set and the time for short and long actuation adjusted. The function of the channels is adjustable separately.

Room temperature control point

The functionality (operating mode switch-over, forced operating mode switch-over, presence function and setpoint temperature shift) can be set.

- The behaviour after the bus voltage returns can be set
- The disabling function can be set

The channel can be disabled by means of a 1-bit object. The following settings are possible: polarity of the disabling object, behaviour at the beginning and at the end of disabling. The channel is not functional during active disabling.

"Switch" channel function

i The "switch" channel function is recommended if telegrams are to be transmitted cyclically on the KNX. This allows monitoring, similar to the heartbeat, to be implemented or rising and falling edges - like with the switch - to be evaluated regardless of the time.

i Available only for a single channel.

- The number of switch objects can be set

Different switch functionalities can be parameterised for each object.

- The behaviour when closing the contact can be set
- The behaviour when opening the contact can be set
- The function of the switch can be set...

- Switching

The command when closing and/or opening can be set (no reaction; switch on; switch off; toggle).

- Forced position

The command when closing and/or opening can be set (no reaction; forcing active, switch on; forcing active, switch off; forcing inactive).

- Value transmitter

The command when closing and/or opening can be set (no reaction, transmit value). The data point type | value range and the value can be set.

- Scene extension

The command when closing and/or opening can be set (call up scene, switch scenes). The scene number can be called up or switched over.

- Room temperature control point

The command when closing and/or opening can be set according to the functionality. The functionality (operating mode switch-over, forced operating mode switch-over, presence function and setpoint temperature shift) can be set.

- The behaviour after the bus voltage returns can be set
- Cyclical transmission can be set
- The disabling function can be set

The channel can be disabled by means of a 1-bit object. The following settings are possible: polarity of the disabling object, behaviour at the beginning and at the end of disabling. The channel is not functional during active disabling.

"Door/window status" channel function

i The function can be implemented with magnetic contacts connected.

i Available for a single channel and in the combined configuration.

- The door/window element to be evaluated can be set
- The door/window number can be assigned
- The evaluation can be adjusted individually
- The evaluation delay can be set
- The object polarity can be set
- The behaviour after the bus voltage returns can be set
- Cyclical transmission can be set
- The disabling function can be set

"Leakage/condensation sensor" channel function

i The function can be implemented with connected leakage or condensation sensors.

i Available only for a single channel.

- The object polarity can be set
- The behaviour after the bus voltage returns can be set
- Cyclical transmission can be set
- The disabling function can be set

"Temperature sensor" channel function

i The function can be implemented with temperature sensors connected to channel 1 or 2.

i Available only for a single channel.

- Temperature measurement by connected sensor possible
- The temperature measurement can be supplemented by an external value via the bus
- Measured values can be weighted
- Measured values can be calibrated

- The transmission behaviour can be set

"Pulse meter" channel function

- i** Available only for a single channel.
 - The counting interval can be set
 - Data point type | value range can be selected, e.g. 1 byte (DPT5.010 | 0..255), 2 bytes (DPT7.001 | 0..65535), 4 bytes (DPT13.001 | -2147483648..2147483647)
 - Pulses can be counted in the event of a rising, falling or rising and falling edge
 - The number of pulses required at the input per indicated counted pulse can be parameterised on the KNX
 - The number of counted pulses required to change the meter reading can be parameterised
 - Each channel has a main meter and intermediate meter
 - The main and intermediate meters can be set separately as up or down meters
 - The start and end values of the meters can be specified by parameters or communication objects
 - The meter reading can be queried or transmitted automatically via the KNX
 - The behaviour after the meter expires can be parameterised (e.g. for synchronisation with visualisation)
 - The pulse meter can be reset via the KNX (meter reset)

Output

- i** An LED lamp can be connected.
- i** Available only for a single channel.
 - Works in the switching function
 - The object polarity can be set

Logic functions

- Up to 8 logic functions can be set
- The type of logic function can be set
- Logic gate...
 - The logic gate can be selected
 - Up to 4 inputs can be set
 - The transmission criterion of the output can be set
- Converter...
 - The reaction of the input can be set
 - The object polarity of the disabling object can be set
 - The output values for IN and OUT can be set
 - The transmission criterion of the output can be set

- Disabling element...
 - The time function for the input of the disabling element can be set
 - The object polarity of the disabling object can be set
 - The filter function for the output of the disabling element can be set
 - The transmission criterion of the output can be set
- Comparator...
 - The data format for the input of the comparator can be set
 - The reference function for the input of the comparator can be set
 - The reference value for the input of the comparator can be set
 - The transmission criterion of the output can be set
- Limit value switch with hysteresis...
 - The data format for the input of the limit switch value can be set
 - The lower threshold value for the input of the limit switch value can be set
 - The upper threshold value for the input of the limit switch value can be set
 - The transmission telegrams can be set according to the threshold value
 - The transmission criterion of the output can be set

7 General settings

The "Information" parameter page provides information on the contact help, ETS compatibility and KNX Secure. No parameterisation is performed on this parameter page.

General settings of the push-button interface are parameterised and general functions enabled on the "General" parameter page.

Channel configuration

Each channel of the push-button interface can be activated and deactivated separately. Each channel can be operated and parameterised separately. Individual channels can execute the following channel functions:

- Push-button
- Switch
- Door/window status
- Leakage/condensation sensor
- Pulse counter
- Output

Combine

Adjacent channels can be combined in activated condition (e.g. K1 + K2). Combined channels can execute the following channel functions:

- Push-button
- Door/window status

i Combined channels can allow, for example, multi-switches (top/bottom), series push-buttons / venetian blind push-buttons / rotary switches, reversing switches/push-buttons to act interactively on a venetian blind via two inputs/channels.

i Combined channels in the "door/window status" channel function can, for example, generate a shared status message for a window with two magnetic contacts.

Times

A delay time after the bus voltage returns is always parameterised for the push-button interface on the "General" parameter page. The delay time after the bus voltage returns is preset to 5 seconds.

i With leakage or condensation sensors selected, the "Delay after bus voltage returns" must be configured to be greater than or equal 5 seconds.

Enabled functions

The channel-wide "logic functions" can be activated for the push-button interface on the "General" parameter page. The number of logic functions can be defined as soon as the "Logic functions" parameter is clicked on.

The "Logic functions" parameter channel with the respective number of "Logic function n " parameter pages is displayed in the parameter view, where the logic functions can be configured.

7.1 Table of parameters

The following parameters are available on the "General" parameter page.

Use (channel 1) (according to K3, K5, K7)	Active Inactive
<p>This parameter in the "Channel configuration" table activates or deactivates the first channel of the push-button interface.</p> <ul style="list-style-type: none"> – The channel is used in the "active" setting. – The channel is not used in the "inactive" setting. 	
Use (channel 2) (according to K4, K6, K8)	Active Inactive
<p>This parameter in the "Channel configuration" table activates or deactivates the second channel of the push-button interface.</p> <ul style="list-style-type: none"> – The channel is used in the "active" setting. – The channel is not used in the "inactive" setting. 	
Combine (channel 1, channel 2) (according to K3, K4) (according to K5, K6) (according to K7, K8)	no K1 + K2
<p>This parameter in the "Channel configuration" table decides whether channels 1 and 2 of the push-button interface each work as single channels or together in the combined configuration.</p> <p>As a single channel, a channel can be parameterised in the "push-button", "switch", "door/window status", "leakage/condensation sensor", "pulse meter" or "output" functions.</p> <p>In this combination, the channels can be parameterised together in the "push-button" or "door/window status" functions.</p>	
Delay after bus voltage return	0 ... 59 min 0 ... 5 ... 59 s 0 ... 900 ms
<p>This parameter defines the delay time for the push-button interface after the bus voltage returns.</p> <p>The device behaves in a channel-oriented manner after the bus voltage returns, depending on the delay time set here.</p>	
Logic functions	Inactive Active
<p>This parameter enables the logic functions globally. If the parameter is activated, the "Logic functions" parameter node becomes available, which contains additional parameter pages. The configuration of the logic functions takes place in this parameter node.</p>	

Number of logic functions	1 ... 8
The number of required logic functions is defined here.	

The following parameters are available on the "Channel n -> K n - General" parameter page.

Name	Free text
The text entered in this parameter is applied to the name of the communication objects and is used for labelling in the ETS parameter window. The text is not programmed in the device.	

Channel function	Push-button Switch Door/window status Leakage/condensation sensor Temperature sensor Pulse counter Output
Each channel of the push-button interface can be activated and deactivated separately. Each channel can be operated and parameterised separately. The individual channels 1 and 2 can execute the following channel functions: <ul style="list-style-type: none"> - Push-button - Switch - Door/window status - Leakage/condensation sensor - Temperature sensor - Pulse counter - Output 	

Channel function	Push-button Switch Door/window status Leakage/condensation sensor Pulse counter Output
------------------	--

Each channel of the push-button interface can be activated and deactivated separately. Each channel can be operated and parameterised separately. The individual channels from channel 3 can execute the following channel functions:

- Push-button
- Switch
- Door/window status
- Leakage/condensation sensor
- Pulse counter
- Output

Channel function	Push-button Door/window status
------------------	--

Each channel of the push-button interface can be activated and deactivated separately. Two adjacent channels can be operated in combination and parameterised together. Combined channels can execute the following channel functions:

- Push-button
- Door/window status

8 Channel-oriented device functions

The following subchapters provide a description of the device functions. Each subchapter consists of the following sections:

- Functional description
- Table of parameters
- Object list

Functional description

The functional description explains the function and provides helpful tips on project design and usage of the function. Cross references support you in your search for further information.

Table of parameters

The table of parameters lists all parameters associated with the function. Each parameter is documented in a table as follows.

Name of the parameter	Parameter values
Parameter description	

Object list

The object list specifies and describes all communication objects associated with the function. Each communication object is documented in a table.

Object no.	This column contains the object number of the communication object.
Function	This column contains the function of the communication object.
Name	This column contains the name of the communication object.
Type	This column contains the length of the communication object.
DPT	This column assigns a datapoint type to a communication object. Datapoint types are standardized in order to ensure interoperability of KNX devices.
Flag	This column assigns the communication flags in accordance with the KNX specification.
C flag	activates / deactivates the communication of the communication object
R flag	enables externally triggered reading of the value from the communication object
W flag	enables externally triggered writing of the value to the communication object
T flag	enables transfer of a value
U flag	enables updating of an object value in case of feedback
I flag	enforces updating of the communication object value when the devices is switched on (reading at init)

8.1 Push-button

The channel function can be parameterised for each channel. The following functions are available in the "push-button" channel function:

- Switching
- Forced position
- Dimming and colour temperature
- Venetian blind / shutter / awning / roof window
- Value transmitter
- Scene extension
- Short and long button actuation
- Room temperature control point

The ETS provides the corresponding parameters and communication objects dynamically for the function according to the parameterised function.

The contact type and debouncing time are to be parameterised separately for each channel. A disabling function can be activated optionally for each push-button channel.

- i The "push-button" channel function is recommended if telegrams are to be transmitted on the KNX, depending on how long the channel/push-button was actuated. For example in the "dimming", "venetian blind", "value transmitter with value adjustment", "telegram upon short or long button actuation" functions or with the "RGB(W) colour adjustment".

8.1.1 Table of parameters

The following parameters are generally available for the "push-button" channel function.

Function	Switching Forced position Dimming and colour temperature Venetian blind / shutter / awning / roof window Value transmitter Scene extension Short and long button actuation Room temperature control point
This parameter determines the function of the push-button connected to the channel.	

Contact type	NO contact NC contact
This parameter determines the contact type of the push-button connected to the channel.	
Debounce time	4 ... 10 ... 255 ms
This parameter specifies the software debouncing time. A signal edge is evaluated at the input after a delay based on this time.	

8.1.2 Switching

In the "push-button" channel function, the push-button can be parameterised in the "switching" function. The ETS indicates up to three communication objects for each channel for the "switching" function. The parameters can be used to determine the value the "switching" object is to obtain when the push-button is pressed and/or released. Furthermore, the behaviour of the channel after the bus voltage returns can be parameterised and a disabling function activated. No distinction is made between a brief or long press.

8.1.2.1 Table of parameters

The following parameters are available in the "push-button" channel function with the parameterised "switching" function.

When pressed	no reaction ON OFF TOGGLE
This parameter defines the reaction when the push-button is pressed.	
When released	no reaction ON OFF TOGGLE
This parameter determines the reaction when the push-button is released.	
After bus voltage return	no reaction Transmit current state ON OFF
<p>This parameter determines the reaction after the bus voltage returns.</p> <p>Either no telegram, a telegram according to the current input state at the channel, an ON telegram or an OFF telegram is transmitted on the bus according to the parameterisation.</p> <p>The reaction after the bus voltage returns takes place only after the parameterised "delay after bus voltage returns" expires ("General" parameter page).</p>	
Disabling function	Inactive Active
This parameter enables the disabling function for the channel.	

At the beginning of the disabling function	no reaction ON OFF TOGGLE
<p>Besides disabling the channel, the device can immediately react when the disabling occurs.</p> <p>This parameter defines the reaction of the channel at the beginning of the disabling.</p>	
At the end of the disabling function	no reaction Transmit current state ON OFF TOGGLE
<p>Besides disabling the channel, the device can immediately react at the end of the disabling.</p> <p>This parameter defines the reaction of the channel at the end of the disabling.</p>	
Object polarity	0 = enabled / 1 = disable 1 = enabled / 0 = disable
<p>This parameter defines the value of the disabling object at which the disabling function is active.</p>	

8.1.2.2 Object list

The following communication objects are available in the "push-button" channel function with the parameterised "switching" function. The name can be adjusted with the "Name" parameter.

Object no.	Function	Name	Type	DPT	Flag
253, 261, ..., 309	Switching	K <i>n</i> - Output	1-bit	1,001	C, R, -, T, A
1-bit object for transmission of switching telegrams (ON, OFF).					

Object no.	Function	Name	Type	DPT	Flag
254, 262, ..., 310	Switching - Status	K <i>n</i> - Input	1-bit	1,001	C, -, W, -, U
1-bit object for receiving feedback telegrams (ON, OFF). This object is visible if the "When pressed" parameter or "When released" parameter is configured to "TOGGLE".					

Object no.	Function	Name	Type	DPT	Flag
255, 263, ..., 311	Switching - Disabling	K <i>n</i> - Input	1-bit	1,003	C, -, W, -, U
1-bit object for activating or deactivating the disabling function. The object polarity can be parameterised.					

8.1.3 Forced position

In the "push-button" channel function, the push-button can be parameterised for the "forced position" function. The ETS indicates up to two communication objects for each channel for the "forced position" function. The parameters can be used to determine the value the "forced position" object is to obtain when the push-button is pressed and/or released. Furthermore, the behaviour of the channel after the bus voltage returns can be parameterised and a disabling function activated. No distinction is made between a brief or long press.

8.1.3.1 Table of parameters

The following parameters are available in the "push-button" channel function with the parameterised "forced position" function.

When pressed	no reaction Forcing active, ON Forcing active, OFF Forcing inactive
This parameter defines the reaction when the push-button is pressed.	
When released	no reaction Forcing active, ON Forcing active, OFF Forcing inactive
This parameter determines the reaction when the push-button is released.	
After bus voltage return	no reaction Transmit current state Forcing active, ON Forcing active, OFF Forcing inactive
This parameter determines the reaction after the bus voltage returns. Either no telegram, a telegram according to the current input state at the channel, a forcing active ON telegram, a forcing active OFF telegram or a forcing inactive telegram is transmitted on the bus according to the parameterisation. The reaction after the bus voltage returns takes place only after the parameterised "delay after bus voltage returns" expires ("General" parameter page).	
Disabling function	Inactive Active
This parameter enables the disabling function for the channel.	

At the beginning of the disabling function	no reaction Forcing active, ON Forcing active, OFF Forcing inactive
Besides disabling the channel, the device can immediately react when the disabling occurs. This parameter defines the reaction of the channel at the beginning of the disabling.	
At the end of the disabling function	no reaction Transmit current state Forcing active, ON Forcing active, OFF Forcing inactive
Besides disabling the channel, the device can immediately react at the end of the disabling. This parameter defines the reaction of the channel at the end of the disabling.	
Object polarity	0 = enabled / 1 = disable 1 = enabled / 0 = disable
This parameter defines the value of the disabling object at which the disabling function is active.	

8.1.3.2 Object list

The following communication objects are available in the "push-button" channel function with the parameterised "forced position" function. The name can be adjusted with the "Name" parameter.

Object no.	Function	Name	Type	DPT	Flag
253, 261, ..., 309	Forced position	K <i>n</i> - Output	2-bit	2,001	C, R, -, T, A
<p>2-bit input object for activating and deactivating the forced position. With the value "1", bit 1 of the telegram activates the forced position. The assigned channels are then locked in the state specified by bit 0 ("0" = OFF / "1" = ON). The value "0" in bit 1 deactivates the forced position again.</p> <p>0x = forcing inactive 10 = forcing active, OFF 11 = forcing active, ON</p>					
Object no.	Function	Name	Type	DPT	Flag
255, 263, ..., 311	Forced position - Disabling	K <i>n</i> - Input	1-bit	1,003	C, -, W, -, U
<p>1-bit object for activating or deactivating the disabling function. The object polarity can be parameterised.</p>					

8.1.4 Dimming and colour temperature

In the "push-button" channel function, the push-button can be parameterised for the "dimming and colour control" function. The ETS indicates up to four communication objects for each channel for the "dimming and colour control" function. The parameters can be used to determine the value the objects "Dimming - ..." obtain when the button is pressed. Furthermore, the behaviour of the channel after the bus voltage returns can be parameterised and a disabling function activated.

Generally, the device transmits a switching telegram after a brief actuation and a dimming telegram after a long actuation. In the standard parameterisation the device transmits a telegram for stopping the dimming action after a long actuation. The duration of pressing the button between switching and dimming is 400 milliseconds in the default parameterisation and can be set in the advanced parameters. The brightness and/or the colour temperature can be dimmed.

- i** The time between switching and dimming should be adjusted according to the parameterised debouncing time.

Status

If an actuator is controlled by multiple control points, the actuator must report its switching status back to the 1-bit object "Dimming - Switching - Status" of the channel. Due to the feedback, the device detects that the actuator has changed its switching status by input from another element and adjusts the dimming direction accordingly. The status is visible only if switchover commands are set.

- i** The dimming direction is always only evaluated and switched locally, unless the actuator changes its switching status due to input from multiple elements (e.g. lighting ON / change of brightness value only). The 4-bit dimming objects and the 3-byte combi object are not tracked via the bus.

Advanced configuration options

The device has advanced parameters for the dimming function. If necessary, these advanced parameters can be activated and thus be made visible.

In the continuous dimming mode (100%), the device transmits a telegram only at the beginning of the long press to start the dimming process and generally a stop telegram after the end of the press. For dimming in small levels it may be useful if the device repeats the dimming telegram in case of a sustained press for a presettable time (parameter "Telegram repetition"). The stop telegram after the end of the press is then not needed.

The following settings are made if the advanced parameters are switched to invisible (advanced parameters = inactive):

- Time between switching and dimming = 400 ms
- Dimming ranges = 100 %
- Stop telegram = active
- Telegram repetition = inactive

8.1.4.1 Brightness

The brightness is dimmed in the default configuration.

The control of the brightness in the "Dimming and colour temperature" function distinguishes between dual-area operation and single-area operation. The parameter "Brightness on pressing" defines the single-area or dual-area dimming function.

dual-area operation	single-area operation
Brighter (ON)	Brighter/darker (TOGGLE)
Darker (OFF)	Brighter (TOGGLE)
	Darker (TOGGLE)

With dual-area operation, the device transmits a telegram for switching on or off after a brief actuation, and a telegram for increasing the brightness ("Brighter") or dimming ("Darker") after a long actuation.

In the event of single-area operation, the device transmits ON and OFF telegrams alternately ("TOGGLE") each time the respective button is briefly pressed. If the button is pressed and held, the device transmits either a telegram for dimming up ("brighter") or down ("darker") or the "Brighter" and "Darker" telegrams alternately.

8.1.4.2 Colour temperature

The "Dimming and colour temperature" function with the control of the colour temperature distinguishes between dual-area operation and single-area operation. The parameter "Colour temperature on pressing" defines the single-surface or double-surface dimming function.

dual-area operation	single-area operation
Colder (ON)	Colder / warmer (TOGGLE)
Warmer (OFF)	Colder (TOGGLE)
	Warmer (TOGGLE)

In the event of dual-area operation, the device transmits a telegram for switching on or off after short actuation and a telegram for dimming to a colder or warmer colour temperature after long actuation.

In the event of single-area operation, the device transmits ON and OFF telegrams alternately ("TOGGLE") each time the respective button is briefly pressed. In the event of long actuation, the device transmits either a telegram for dimming colder or warmer or the "Colour temperature colder" and "Colour temperature warmer" telegrams alternately.

8.1.4.3 Brightness and colour temperature

The dimming process can only adjust either the brightness or the colour temperature via individual objects.

Optionally, the brightness and the colour temperature can also be adjusted together via a combi object.

The "Dimming and colour temperature" function with the control of the brightness and colour temperature distinguishes between dual-area operation and single-area operation. The parameter "Brightness + colour temperature on pressing" defines the single-area or dual-area dimming function.

dual-area operation	single-area operation
Brighter + colder (ON)	Brighter + colder / darker + warmer (TOGGLE)
Darker + warmer (OFF)	Brighter + colder (TOGGLE)
	Darker + warmer (TOGGLE)

In dual-area operation, the device sends a telegram for switching on or off in the event of brief actuation and a telegram for brighter/colder or darker/warmer dimming in the event of long actuation.

In the event of single-area operation, the device transmits ON and OFF telegrams alternately ("TOGGLE") each time the respective button is briefly pressed. In the event of long actuation, the device transmits either a telegram for brighter/colder dimming or darker/warmer dimming or the "Brighter + colder" and "Darker + warmer" telegrams alternately.

8.1.4.4 Table of parameters

The following parameters are available in the "push-button" channel function with the parameterised "Dimming and colour temperature" function.

Dimming control	Single object: brightness Single object: colour temperature Combi object: brightness + colour temperature
With this parameter, either the brightness or the colour temperature can be dimmed by means of an individual object, or the brightness and colour temperature can be controlled together by means of a combination object	
Brightness on pressing	no reaction Brighter (ON) Darker (OFF) Brighter/darker (TOGGLE) Brighter (TOGGLE) Darker (TOGGLE)
This parameter defines the reaction when a button is pressed. If the device is to toggle on a brief press, the corresponding switching objects of other sensors with the same function must be interlinked. This parameter is visible only if: dimming control = individual object: brightness	
Colour temperature on pressing	no reaction Colder (ON) Warmer (OFF) Colder / warmer (TOGGLE) Colder (TOGGLE) Warmer (TOGGLE)
This parameter defines the reaction when a button is pressed. If the device is to toggle on a brief press, the corresponding switching objects of other sensors with the same function must be interlinked. This parameter is visible only if: dimming control = individual object: colour temperature	

Brightness + colour temperature on pressing	no reaction Brighter + colder (ON) Darker + warmer (OFF) Brighter + colder / darker + warmer (TOGGLE) Brighter + colder (TOGGLE) Darker + warmer (TOGGLE)
---	---

This parameter defines the reaction when a button is pressed.
 If the device is to toggle on a brief press, the corresponding switching objects of other sensors with the same function must be interlinked.
 This parameter is visible only if: dimming control = combination object: brightness + colour temperature

Advanced parameters	Active Inactive
---------------------	---------------------------

When the advanced parameters are activated, the ETS shows the following parameters.

Time between switching and dimming	0 ... 50 s 100 ... 400 ... 990 ms
------------------------------------	--

This parameter defines how long the button must be pressed for a dimming telegram to be transmitted.

Increase brightness by	1.5 % 3 % 6 % 12.5 % 25 % 50 % 100 %
------------------------	---

This parameter sets the relative dimming level when the brightness is increased. On each button actuation, the brightness is changed at maximum by the configured step width.
 It is recommended that the device repeats the dimming telegrams automatically, particularly with a small dimming level (see "Telegram repetition").

Reduce brightness by	1.5 % 3 % 6 % 12.5 % 25 % 50 % 100 %
<p>This parameter sets the relative dimming level when the brightness is reduced. On each button actuation, the brightness is changed at maximum by the configured step width.</p> <p>It is recommended that the device repeats the dimming telegrams automatically, particularly with a small dimming level (see "Telegram repetition").</p>	
Colour temperature colder by	1.5 % 3 % 6 % 12.5 % 25 % 50 % 100 %
<p>This parameter sets the relative dimming level when the colour temperature is increased. On each button actuation, the brightness is changed at maximum by the configured step width.</p> <p>It is recommended that the device repeats the dimming telegrams automatically, particularly with a small dimming level (see "Telegram repetition").</p>	
Colour temperature warmer by	1.5 % 3 % 6 % 12.5 % 25 % 50 % 100 %
<p>This parameter sets the relative dimming level when the colour temperature is reduced. On each button actuation, the brightness is changed at maximum by the configured step width.</p> <p>It is recommended that the device repeats the dimming telegrams automatically, particularly with a small dimming level (see "Telegram repetition").</p>	

Stop telegram	Active Inactive
<p>On "Active" the device transmits a telegram for stopping the dimming process when the button is released.</p> <p>When the device transmits telegrams for dimming in smaller levels, the stop telegram is generally not needed.</p>	
Telegram repetition	Active Inactive
<p>This parameter can be used to activate telegram repetition for dimming. With telegram repetition activated, the device cyclically sends relative dimming telegrams (in the parameterised step width) to the bus if the button is pressed long.</p>	
Time between two telegrams	200 ms 300 ms 400 ms 500 ms 750 ms 1000 ms 2000 ms
<p>This parameter defines the interval at which the dimming telegrams are automatically repeated in the telegram repetition mode.</p> <p>This parameter is only visible if "Telegram repetition = active"!</p>	
After bus voltage return	no reaction Transmit current state ON OFF
<p>This parameter determines the reaction after the bus voltage returns.</p> <p>Either no telegram, a telegram according to the current input state at the channel, an ON telegram or an OFF telegram is transmitted on the bus according to the parameterisation.</p> <p>The reaction after the bus voltage returns takes place only after the parameterised "delay after bus voltage returns" expires ("General" parameter page).</p>	
Disabling function	Inactive Active
<p>This parameter enables the disabling function for the channel.</p>	

At the beginning of the disabling function	no reaction ON OFF TOGGLE
<p>Besides disabling the channel, the device can immediately react when the disabling occurs.</p> <p>This parameter defines the reaction of the channel at the beginning of the disabling.</p>	
At the end of the disabling function	no reaction Transmit current state ON OFF TOGGLE
<p>Besides disabling the channel, the device can immediately react at the end of the disabling.</p> <p>This parameter defines the reaction of the channel at the end of the disabling.</p>	
Object polarity	0 = enabled / 1 = disable 1 = enabled / 0 = disable
<p>This parameter defines the value of the disabling object at which the disabling function is active.</p>	

8.1.4.5 Object list

The following communication objects are available in the "push-button" channel function with the parameterised "dimming and colour temperature" function. The name can be adjusted with the "Name" parameter.

Object no.	Function	Name	Type	DPT	Flag
317, 323, ..., 359	Dimming - Switching	K <i>n</i> - Output	1-bit	1,001	C, R, -, T, A
1-bit object for transmission of switching telegrams (ON, OFF).					

Object no.	Function	Name	Type	DPT	Flag
318, 324, ..., 360	Dimming - Brightness	K <i>n</i> - Output	4-bit	3,007	C, R, -, T, A
4-bit object for sending relative dimming telegrams to adjust the brightness.					

Object no.	Function	Name	Type	DPT	Flag
318, 324, ..., 360	Dimming - Brightness and colour temperature	K <i>n</i> - Output	3-byte	250,600	C, R, -, T, A
3-byte object for sending dimming telegrams for adjusting the brightness and the colour temperature in combination.					

Object no.	Function	Name	Type	DPT	Flag
319, 325, ..., 361	Dimming - Switching - Status	K <i>n</i> - Input	1-bit	1,001	C, -, W, -, U
1-bit object for receiving feedback telegrams (ON, OFF). This object is visible if the parameter "... when pressed" is parameterised to "TOGGLE".					

Object no.	Function	Name	Type	DPT	Flag
320, 326, ..., 362	Dimming - Colour temperature	K <i>n</i> - Output	4-bit	3,007	C, R, -, T, A
4-bit object for sending relative dimming telegrams to adjust the colour temperature.					

Object no.	Function	Name	Type	DPT	Flag
321, 327, ..., 363	Dimming - Disabling	K <i>n</i> - Input	1-bit	1,003	C, -, W, -, U
1-bit object for activating or deactivating the disabling function. The object polarity can be parameterised.					

8.1.5 Venetian blind / shutter / awning / roof window

In the "push-button" channel function, the push-button can be parameterised for the "venetian blind / shutter / awning / roof window" function. The ETS indicates up to three communication objects for each channel for the "venetian blind / shutter / awning / roof window" function. The parameters can be used to determine the values the "venetian blind" objects obtain when the push-button is pressed. Furthermore, the behaviour of the channel after the bus voltage returns can be parameterised and a disabling function activated.

The "Type of blind/shutter" parameter can be used to select whether "venetian blind" or "shutter / awning / skylight" are to be controlled. The selectable values of the "Command sequence" parameter vary, depending on the setting.

The "venetian blind / shutter / awning / skylight" function distinguishes between dual-area operation (UP, DOWN) and single-area operation (TOGGLE). The "Command on pressing" parameter defines the single-area or double-area blind function.

dual-area operation	single-area operation
UP	TOGGLE
DOWN	

Dual-area operation means that e.g. the device transmits a telegram for upward movement if one channel is actuated and a telegram for downward movement if a different channel is actuated.

Single-area operation means the device changes the direction of the long-time telegram after each long actuation. Several short time telegrams in succession have the same direction.

Status

If the actuator can be controlled from several sensors, a faultless single-area operation requires that the long time objects of the control elements are interlinked. The device would otherwise not be able to detect that the actuator has been addressed from another sensor, in which case it would have to be actuated twice during the next use in order to produce the desired reaction.

Operating concepts

For the control of venetian blind, roller shutter, awning or similar drives, the device supports four operating concepts in which the telegrams are transmitted in different time sequences. The device can therefore be used to operate a wide variety of drive configurations.

"Step - Up/down - Step" operating concept:

- i** The "Step - Up/down – Step" operating concept replaces the "Short - Long - Short" operating concept.

When selecting the operating concept "Step – Up/down – Step", the device behaves as follows:

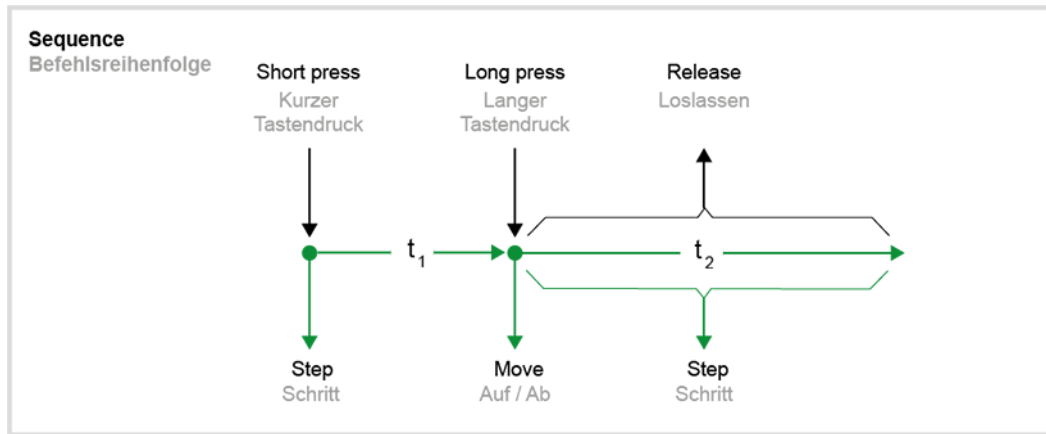

Figure 10: "Step - Up/down - Step" operating concept

- Immediately on pressing the button, the device transmits a short time telegram. This stops a running drive and starts the time t_1 ("long button actuation"). No other telegram will be sent if the button is released within t_1 . This short time serves the purpose of stopping a continuous movement. The time "long button actuation from" selected in the device should be shorter than the short time operation of the actuator to prevent jerky motion of the venetian blind.
- If the button is kept depressed for longer than t_1 , the push-button will send a long-time telegram at the end of t_1 to move the drive, and the time t_2 ("slat adjustment time window") will be started.
- If the button is released within the time window, the device will send another short-time telegram. This function is used for adjusting the slats of a venetian blind. The function permits stopping the slats in any position during their rotation. The "slat adjustment time window" should be chosen as required by the drive to completely rotate the slats. If the selected "slat adjustment time window" is longer than the complete running time of the drive, a pushbutton function is possible as well. This means that the drive is active only when the button is kept depressed.
- If the button is kept depressed for longer than t_2 , the device will not send another telegram. The drive remains on until the end position is reached.

"Up/down - Step" operating concept:

- i** The "Up/down – Step" operating concept replaces the "Long - Short" operating concept.

If the operating concept "Up/down – Step" is selected, the device behaves as follows:

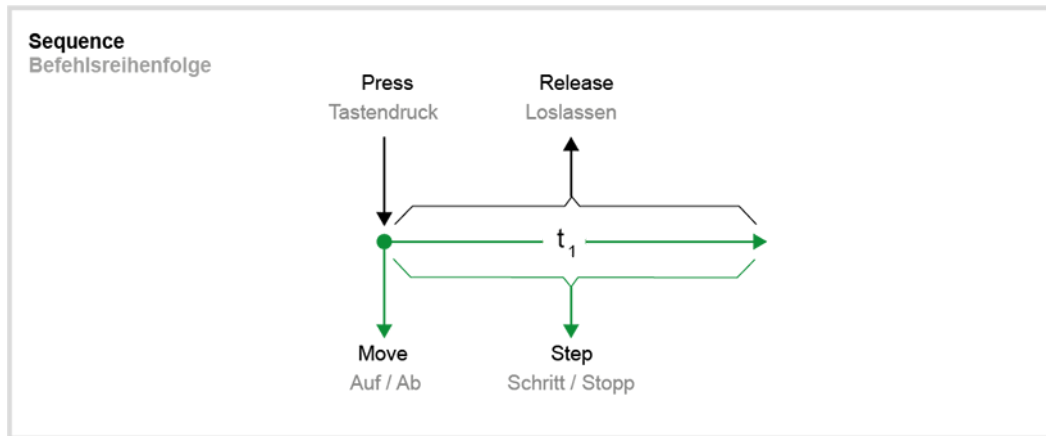

Figure 11: "Up/down - Step" operating concept

- Immediately on pressing the button, the device transmits a long time telegram. The drive begins to move and the time t_1 ("slat adjustment time window") is started.

i Venetian blind actuators should generate a break when changing the direction of travel to prevent motor damage.

- If the button is released within the slat adjustment time window, the device will send a short-time telegram. This function is used for adjusting the slats of a venetian blind. The function permits stopping the slats in any position during their rotation.

The "slat adjustment time window" should be chosen as required by the drive to completely rotate the slats. If the selected "slat adjustment time window" is longer than the complete running time of the drive, a pushbutton function is possible as well. This means that the drive is active only when the button is kept depressed.

- If the button is kept depressed for longer than t_1 , the device will not send another telegram. The drive remains on until the end position is reached.

"Step - Up/down" operating concept:

i The "Step - Up/down" operating concept replaces the "Short - Long" operating concept.

If the operating concept "Step – Up/down" is selected, the device will behave as follows:

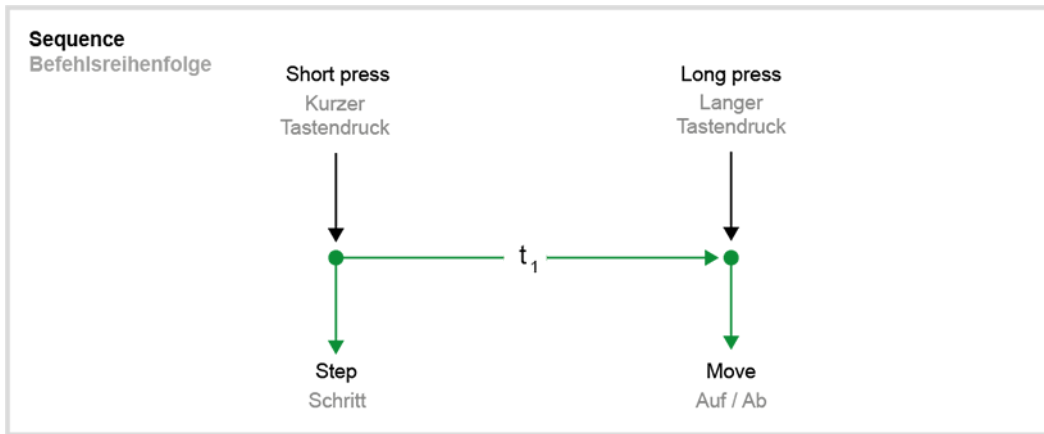

Figure 12: "Step - Up/down" operating concept

- Immediately on pressing the button, the device transmits a short time telegram. This stops a running drive and starts the time t_1 ("long button actuation"). No other telegram will be sent if the button is released within t_1 . This short time serves the purpose of stopping a continuous movement. The time "long button actuation from" selected in the device should be shorter than the short time operation of the actuator to prevent jerky motion of the venetian blind.
- If the button is kept depressed for longer than t_1 , the push-button will transmit a long-time telegram to start the drive at the end of t_1 .
- No further telegram is transmitted when the push-button is released. The drive remains on until the end position is reached.

"Up/down - Step or step" operating concept:

i The "Up/down – Step or step" operating concept replaces the "Long - Short or short" operating concept.

If the operating concept "Up/down – Step or step" is selected, the device will behave as follows:

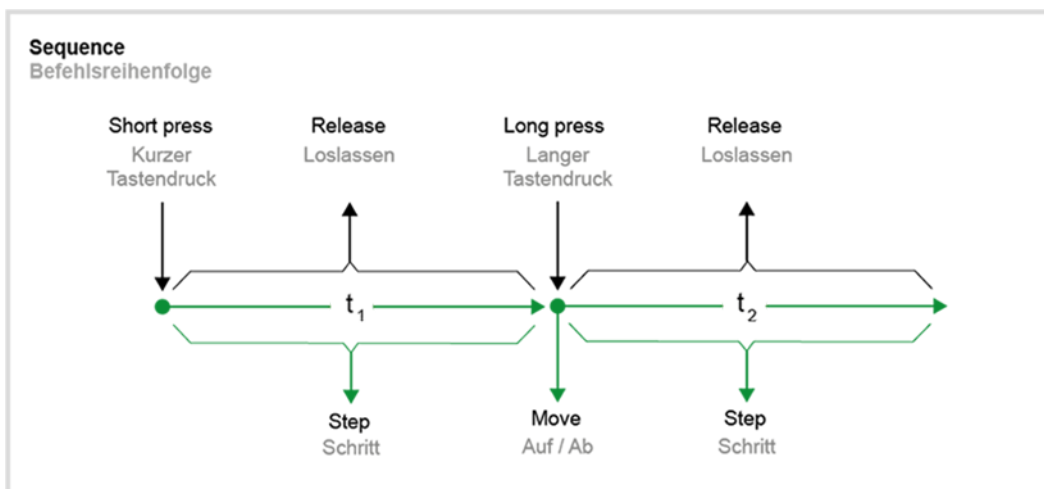

Figure 13: "Up/down – Step or step" operating concept

- Immediately after pressing the button, the device starts the time t_1 ("long button actuation") and waits. If the button is released again before t_1 expires, the device will send a short-time telegram. This telegram can be used to stop a running drive. A stationary drive rotates the slats by one level.
 - If the button is kept depressed after t_1 expires, the device will send a long-time telegram and start the time t_2 ("slat adjustment time window").
- i** Venetian blind actuators should generate a break when changing the direction of travel to prevent motor damage.
- If the button is released within t_2 , the device will send another short-time telegram. This function is used for adjusting the slats of a venetian blind. The function permits stopping the slats in any position during their rotation. The "slat adjustment time window" should be chosen as required by the drive to completely rotate the slats. If the selected "slat adjustment time window" is longer than the complete running time of the drive, a pushbutton function is possible as well. This means that the drive is active only when the button is kept depressed.
 - If the button is kept depressed for longer than t_2 , the device will not send another telegram. The drive remains on until the end position is reached.

8.1.5.1 Table of parameters

The following parameters are available in the "push-button" channel function with the parameterised function "venetian blind / shutter / awning / roof window".

Type of blind/shutter	Venetian blind Shutter / awning / roof window
This parameter defines the type of blind/shutter to be controlled and optimises the available setting options of the channel function.	
Command on pressing	UP DOWN TOGGLE
This parameter defines the running direction of the drive on pressing the button. If the setting is "TOGGLE", the direction is changed after each long time command. If several devices are to control the same drive, the long time objects of the devices must be interlinked to ensure that the running direction can be changed correctly.	
Command sequence	Up/down - Step Step - Up/down
Two different operating concepts can be selected to actuate the "shutter / awning / roof window" blind/shutter types.	
Command sequence	Step - Up/down - Step Up/down - Step Step - Up/down Step - Up/down or step
For venetian blind control, four different operating concepts can be selected.	
Long button actuation from (t1)	0 ... 59 s 100 ... 400 ... 990 ms
This parameter sets the time after which the long-time operation will be evaluated on pressing the button. This parameter is not visible for the "command sequence = Up/down - Step"	
Time window for slat adjustment (t2)	0 ... 59 s 0 ... 500 ... 990 ms
The time during which a transmitted MOVE telegram can be terminated by releasing the button (STEP) is set here. This function serves to adjust the slats of a venetian blind. This parameter is not visible for the "command sequence = Step - Up/down"	
Show info graphic	Active Inactive
If info graphic is activated, the graphic diagram of the command sequence and related text information are displayed.	

After bus voltage return	no reaction Transmit current state UP DOWN
This parameter determines the reaction after the bus voltage returns. Either no telegram, a telegram according to the current input state at the channel, an UP telegram or a DOWN telegram is transmitted on the bus according to the parameterisation. The reaction after the bus voltage returns takes place only after the parameterised "delay after bus voltage returns" expires ("General" parameter page).	
Disabling function	Inactive Active
This parameter enables the disabling function for the channel.	
At the beginning of the disabling function	no reaction UP DOWN
Besides disabling the channel, the device can immediately react when the disabling occurs. This parameter defines the reaction of the channel at the beginning of the disabling.	
At the end of the disabling function	no reaction Transmit current state UP DOWN
Besides disabling the channel, the device can immediately react at the end of the disabling. This parameter defines the reaction of the channel at the end of the disabling.	
Object polarity	0 = enabled / 1 = disable 1 = enabled / 0 = disable
This parameter defines the value of the disabling object at which the disabling function is active.	

8.1.5.2 Object list

The following communication objects are available in the "push-button" channel function with the parameterised function "venetian blind / shutter / awning / roof window". The name can be adjusted with the "Name" parameter.

Object no.	Function	Name	Type	DPT	Flag
365, 369, ..., 393	Venetian blind - Short time operation	K <i>n</i> - Output	1-bit	1,007	C, R, -, T, A
1-bit object for the transmission of telegrams with which a venetian blind or shutter drive motor can be stopped or with which the blind slats can be adjusted by short time operation.					

Object no.	Function	Name	Type	DPT	Flag
366, 370, ..., 394	Venetian blind - Long time operation	K <i>n</i> - Output	1-bit	1,008	C, R, W, T, A
1-bit object for the transmission of telegrams with which a venetian blind or shutter drive motor can be moved upwards or downwards.					

Object no.	Function	Name	Type	DPT	Flag
367, 371, ..., 395	Venetian blind - Disabling	K <i>n</i> - Input	1-bit	1,003	C, -, W, -, U
1-bit object for activating or deactivating the disabling function. The object polarity can be parameterised.					

8.1.6 Value transmitter

In the "push-button" channel function, the push-button can be parameterised for the "value transmitter" function. The ETS indicates up to six communication objects for each channel for the "value transmitter" function. The parameters can be used to determine the value the "value transmitter" objects obtain when the button is pressed.

With the "Value transmitter" function, the device sends parameterised values to the bus at the press of a button.

Value adjustment

Furthermore, a value adjustment and the behaviour of the channel after the bus voltage returns can be parameterised and a disabling function activated. No distinction is made between a brief or long press.

In the function as value transmitter with value adjustment, the device transmits the parameterised value when the button is briefly pressed. After the initial value adjustment, the device still transmits the parameterised value or the device takes the value to be transmitted depending on the parameterisation from the value adjustment or from the status object if the button is briefly pressed. This allows fixed or changeable values or values transmitted via the bus to be called up.

Optionally, the channel adjusts the value if the button is pressed for a long time. This allows, for example, absolute dimming of the values to be generated. The direction of the value adjustment can be parameterised in the process. The value adjustment can be configured flexibly by allowing the starting time in the event of pressing the button for a long time and the time between the telegrams to be parameterised.

- i** The value adjustment is not available, with "DPT 249.600 | colour temperature value + brightness" and "RGBW/HSVW colour value".

Value ranges

The value transmitter knows 14 different value ranges. The parameter "Data point type | Value range" determines the value range used by the value transmitter, depending on the application case:

Function	Function	Lower numerical limit	Upper numerical limit
1-byte value transmitter	0...100%	0%	100%
1-byte value transmitter	0...255	0	255
1-byte value transmitter	0...360°	0°	360°
1-byte value transmitter	0...255%	0%	255%
1-byte value transmitter	-128...127	-128	127

Function	Function	Lower numerical limit	Upper numerical limit
2-byte value transmitter	0...65535	0	65535
2-byte value transmitter	Colour temperature value	1000 K	10000 K
2-byte value transmitter	-32768...32767	-32768	32767
2-byte value transmitter	Temperature value	0°C	40°C
2-byte value transmitter	Brightness value	0 lux	1500 lux
6-byte value transmitter	Colour temperature value + brightness	1000 K 0%	10000 K 100%
3-byte value transmitter	RGB/HSV with colour wheel sequence	#000000	#FFFFFF
3-byte value transmitter	RGB/HSV with brightness adjustment	#000000	#FFFFFF
6-byte value transmitter	Colour value RGBW/HSVW	#000000 + 0	#FFFFFF + 255

For each of these ranges, the value that can be transmitted to the bus for each button actuation is configurable.

8.1.6.1 Table of parameters

The following parameters are available in the "push-button" channel function with the parameterised "value transmitter" function.

Data point type Value range	DPT 5.001 0 ... 100% DPT 5.010 0 ... 255 DPT 5.003 0 ... 360° DPT 5.004 0 ... 255% DPT 6.010 -128 ... 127 DPT 7.001 0 ... 65535 DPT 7.600 1000 ... 10000 K DPT 8.001 -32768 ... 32767 DPT 9.001 0 ... 40°C DPT 9.004 0 ... 1500 lux DPT 249.600 Colour temperature value + brightness RGB/HSV with colour wheel sequence (RGB: DPT 232.600, HSV: DPT 5.003, DPT 5.001, DPT 5.001) RGB/HSV with brightness adjustment (RGB: DPT 232.600, HSV: DPT 5.003, DPT 5.001, DPT 5.001) Colour value RGBW/HSVW (RGBW: DPT 251.600, HSVW: DPT 5.003, DPT 5.001, DPT 5.001, DPT 5.001)
-------------------------------	--

The "value transmitter" function distinguishes between 1-byte, 2-byte 3-byte and 6-byte values.

The following parameters and their settings depend on the setting for this parameter.

Value when pressed	0 ... 100%
This parameter defines the object value when the button is pressed. It is visible only if "data point type value range = DPT 5.001 0 ... 100%".	
Value when pressed	0 ... 255
This parameter defines the object value when the button is pressed. It is visible only if "data point type value range = DPT 5.010 0 ... 255".	
Value when pressed	0 ... 360°
This parameter defines the object value when the button is pressed. It is visible only if "data point type value range = DPT 5.003 0 ... 360°".	

Value when pressed	0 ... 255%
This parameter defines the object value when the button is pressed. It is visible only if "data point type value range = DPT 5.004 0 ... 255%".	
Value when pressed	-128...0 ...127
This parameter defines the object value when the button is pressed. It is visible only if "data point type value range = DPT 6.010 -128 ... 127".	
Value when pressed	0 ... 65535
This parameter defines the object value when the button is pressed. It is visible only if "data point type value range = DPT 7.001 0 ... 65535".	
Colour temperature value when pressed	1000 ... 2700 ... 10000 K
This parameter defines the object value when the button is pressed. It is visible only if "data point type value range = DPT 7.600 1000 ... 10000 K".	
Value when pressed	-32768 ... 0 ... 32767
This parameter defines the object value when the button is pressed. It is visible only if "data point type value range = DPT 8.001 -32768 ... 32767".	
Temperature value when pressed	0 ... 20 ... 40°C
This parameter defines the object value when the button is pressed. It is visible only if "data point type value range = DPT 9.001 0 ... 40°C".	
Brightness value when pressed	0, 50 ... 300 ... 1500 lux
This parameter defines the object value when the button is pressed. It is visible only if "data point type value range = DPT 9.004 0 ... 1500 lux".	
Colour temperature value when pressed	1000 ... 2700 ... 10000 K
This parameter defines the object value when the button is pressed. It is visible only if "data point type value range = DPT 249.600 colour temperature value + brightness".	
Brightness value when pressed	0 ... 100%
This parameter defines the object value when the button is pressed. It is visible only if "data point type value range = DPT 249.600 colour temperature value + brightness".	
Adjustment duration in the actuator	0 ... 100 min, 0, 1 ... 59 s, 0 ... 900 ms
This parameter defines the object value when the button is pressed. It is visible only if "data point type value range = DPT 249.600 colour temperature value + brightness".	

Colour value when pressed	#000000 ... #FFFFFF
<p>This parameter determines the object values of the value transmitter 3-byte (or value transmitter 6-byte), brightness value (V), saturation (S) and colour hue (H) objects when the button is pressed.</p> <p>It is visible with "data point type value range = RGB/HSV with colour wheel sequence (RGB: DPT 232.600, HSV: DPT 5.003, DPT 5.001, DPT 5.001)", "data point type value range = RGB/HSV with brightness adjustment (RGB: DPT 232.600, HSV: DPT 5.003, DPT 5.001, DPT 5.001)" and "data point type value range = colour value RGBW/HSVW (RGBW: DPT 251.600, HSVW: DPT 5.003, DPT 5.001, DPT 5.001, DPT 5.001)".</p> <p>The value (RGB/HSV) is configured by means of a colour picker.</p> <p>With the data point type value range "colour value RGBW/HSVW (RGBW: DPT 251.600, HSVW: DPT 5.003, DPT 5.001, DPT 5.001, DPT 5.001)", the white value is configured by means of a separate slider.</p>	
White value when pressed	0 ... 255
<p>This parameter defines the object value of the white level (W) object when the button is pressed.</p> <p>It is visible only if "data point type value range = colour value RGBW/HSVW (RGBW: DPT 251.600, HSVW: DPT 5.003, DPT 5.001, DPT 5.001, DPT 5.001)".</p>	
Value adjustment	Active Inactive
<p>In the "push-button" channel function, the device can adjust the value in the "value transmitter" function.</p> <p>If the value adjustment is activated by a long button-press, the ETS shows further parameters.</p> <p>i The value adjustment is not available, with "DPT 249.600 colour temperature value + brightness" and "RGBW/HSVW colour value".</p>	
Start value	same as configured value Same as value after last adjustment Like value from status object
<p>Value adjustment can begin with different starting values.</p> <p>With "same as configured value": After each long press, the device always starts with the value configured in the ETS.</p> <p>With "same as value after last adjustment": After a long press, the device starts with the value transmitted by itself or by another device with this group address as the last value.</p> <p>With "same as value from status object": When the push-button is pressed for a long time, the device starts with the value that it or another device with this group address transmitted as the last value.</p> <p>i This selection is available only with 1-byte or 2-byte value transmitters.</p>	

Start value	As parameterised colour value Same as value after last adjustment As value from status object colour angle (H) Like value from status object RGB
<p>Value adjustment can begin with different starting values.</p> <p>With "same as parameterised colour value": After each long actuation, the device always starts with the value programmed by the ETS.</p> <p>With "same as value after last adjustment": After a long press, the device starts with the value transmitted by itself or by another device with this group address as the last value.</p> <p>With "same as value from colour hue (H) status object": After long actuation, the device starts with the value that it or another device with this group address transmitted as the last value.</p> <p>With "same as value from RGB status object": After long actuation, the device starts with the value that it or another device with this group address transmitted as the last value.</p> <p> This selection is available only with RGB/HSV with colour wheel sequence.</p>	

Start value	As parameterised colour value Same as value after last adjustment As value from status object brightness (V) Like value from status object RGB
<p>Value adjustment can begin with different starting values.</p> <p>With "same as parameterised colour value": After each long actuation, the device always starts with the value programmed by the ETS.</p> <p>With "same as value after last adjustment": After a long press, the device starts with the value transmitted by itself or by another device with this group address as the last value.</p> <p>With "same as value from brightness (V) status object": After long actuation, the device starts with the value that it or another device with this group address transmitted as the last value.</p> <p>With "same as value from RGB status object": After long actuation, the device starts with the value that it or another device with this group address transmitted as the last value.</p> <p> This selection is available only with RGB/HSV with brightness adjustment.</p>	

Direction	Upwards Downwards Toggleing (alternating)
With a long press, the device can either vary the values always in the same direction or it stores the direction of the last adjustment and reverses it on the next button-press.	
i This selection is available only with 1-byte or 2-byte value transmitters.	

Direction	Colour sequence in clockwise direction (red -> green -> blue -> red -> ...) Colour sequence in anti-clockwise direction (red -> blue -> green -> red -> ...) Toggleing colour sequence (alternating with each new rising edge)
With a long press, the device can either vary the values always in the same direction or it stores the direction of the last adjustment and reverses it on the next button-press.	
i This selection is available only with RGB/HSV with colour wheel sequence.	

Direction	Brighter Darker Toggleing (alternating)
With a long press, the device can either vary the values always in the same direction or it stores the direction of the last adjustment and reverses it on the next button-press.	
i This selection is available only with RGB/HSV with brightness adjustment.	

Increment	1 ... 15
In a value adjustment, the device determines the new telegram value from the previous value and the preset step width. If the value falls below the lower limit of the adjustment range or if it exceeds the upper limit, the sensor adapts the step width of the last step automatically.	
i This selection is available only with 1-byte value transmitters.	

Increment	1, 2, 5, 10, 20, 50, 75, 100 , 200, 500, 750, 1000
In a value adjustment, the device determines the new telegram value from the previous value and the preset step width. If the value falls below the lower limit of the adjustment range or if it exceeds the upper limit, the sensor adapts the step width of the last step automatically.	
i This selection is available only with 2-byte value transmitters (0 ... 65535 and -32768 ... 32767).	

Increment	0.5, 1, 1.5, 2, ..., 40
<p>In a value adjustment, the device determines the new telegram value from the previous value and the preset step width. If the value falls below the lower limit of the adjustment range or if it exceeds the upper limit, the sensor adapts the step width of the last step automatically.</p> <p>i This selection is available only with 2-byte value transmitters (0 ... 40°C).</p>	
Increment	1, 10, 20, ..., 500 , ..., 1000
<p>In a value adjustment, the device determines the new telegram value from the previous value and the preset step width. If the value falls below the lower limit of the adjustment range or if it exceeds the upper limit, the sensor adapts the step width of the last step automatically.</p> <p>i This selection is available only with 2-byte value transmitters (1000 ... 10000 K).</p>	
Increment	1, 2, 3, ..., 50 , ..., 1500 lux
<p>In a value adjustment, the device determines the new telegram value from the previous value and the preset step width. If the value falls below the lower limit of the adjustment range or if it exceeds the upper limit, the sensor adapts the step width of the last step automatically.</p> <p>i This selection is available only with 2-byte value transmitters (0 ... 1500 lux).</p>	
Increment	1, 2, 4, 5, 10, 20, 25, 30, 50, 60 °
<p>In a value adjustment, the device determines the new telegram value from the previous value and the preset step width. If the value falls below the lower limit of the adjustment range or if it exceeds the upper limit, the sensor adapts the step width of the last step automatically.</p> <p>i This selection is available only with 3-byte value transmitters (RGB/HSV).</p>	
Value adjustment starts after	0.5 s after pressing the button 1 s after pressing the button 2 s after pressing the button 3 s after pressing the button 5 s after pressing the button
<p>This parameter determines the time from when the device starts the value adjustment after a key is pressed.</p>	
Time between two telegrams	0.5 s 1 s 2 s 3 s
<p>This parameter defines the interval at which the device transmits new telegrams during a value adjustment.</p>	

Value adjustment with overflow	Active Inactive
<p>If value adjustment is to be effected without overflow (setting "inactive") and if the device reaches the lower limit of the adjustment range or the upper limit during value adjustment, the adjustment will be stopped automatically by the sensor.</p> <p>If the value adjustment with overflow is programmed (setting "active") and if the device reaches the lower or the upper limit, it will transmit the value of this range limit and then add a pause the duration of which corresponds to two levels. Thereafter, the device transmits a telegram with the value of the other range limit and continues the value adjustment in the same direction.</p>	
After bus voltage return	no reaction Transmit current state Transmit value
<p>This parameter determines the reaction after the bus voltage returns.</p> <p>Either no telegram, a telegram according to the current input state at the channel or a value parameterised accordingly for the set data point type value range is transmitted on the bus.</p> <p>The reaction after the bus voltage returns takes place only after the parameterised "delay after bus voltage returns" expires ("General" parameter page).</p>	
Value	0 ... 100%
<p>This parameter determines the object value after the bus voltage returns.</p> <p>It is visible only if "data point type value range = DPT 5.001 0 ... 100%".</p>	
Value	0 ... 255
<p>This parameter determines the object value after the bus voltage returns.</p> <p>It is visible only if "data point type value range = DPT 5.010 0 ... 255".</p>	
Value	0 ... 360°
<p>This parameter determines the object value after the bus voltage returns.</p> <p>It is visible only if "data point type value range = DPT 5.003 0 ... 360°".</p>	
Value	0 ... 255%
<p>This parameter determines the object value after the bus voltage returns.</p> <p>It is visible only if "data point type value range = DPT 5.004 0 ... 255%".</p>	
Value	-128...0 ... 127
<p>This parameter determines the object value after the bus voltage returns.</p> <p>It is visible only if "data point type value range = DPT 6.010 -128 ... 127".</p>	
Value	0 ... 65535
<p>This parameter determines the object value after the bus voltage returns.</p> <p>It is visible only if "data point type value range = DPT 7.001 0 ... 65535".</p>	

Colour temperature value	1000 ... 2700 ... 10000 K
This parameter determines the object value after the bus voltage returns. It is visible only if "data point type value range = DPT 7.600 1000 ... 10000 K".	
Value	-32768 ... 0 ... 32767
This parameter determines the object value after the bus voltage returns. It is visible only if "data point type value range = DPT 8.001 -32768 ... 32767".	
Temperature value	0 ... 20 ... 40°C
This parameter determines the object value after the bus voltage returns. It is visible only if "data point type value range = DPT 9.001 0 ... 40°C".	
Brightness value	0, 50 ... 300 ... 1500 lux
This parameter determines the object value after the bus voltage returns. It is visible only if "data point type value range = DPT 9.004 0 ... 1500 lux".	
Colour temperature value	1000 ... 2700 ... 10000 K
This parameter determines the object value after the bus voltage returns. It is visible only if "data point type value range = DPT 249.600 colour temperature value + brightness".	
Brightness value	0 ... 100%
This parameter determines the object value after the bus voltage returns. It is visible only if "data point type value range = DPT 249.600 colour temperature value + brightness".	
Adjustment duration in the actuator	0 ... 100 min, 0, 1 ... 59 s, 0 ... 900 ms
This parameter determines the object value after the bus voltage returns. It is visible only if "data point type value range = DPT 249.600 colour temperature value + brightness".	
Colour value	#000000 ... #FFFFFF
This parameter determines the object values of the 3-byte value transmitter (or 6-byte value transmitter), brightness value (V), saturation (S) and colour hue (H) objects after the bus voltage returns. It is visible with "data point type value range = RGB/HSV with colour wheel sequence (RGB: DPT 232.600, HSV: DPT 5.003, DPT 5.001, DPT 5.001)", "data point type value range = RGB/HSV with brightness adjustment (RGB: DPT 232.600, HSV: DPT 5.003, DPT 5.001, DPT 5.001)" and "data point type value range = colour value RGBW/HSVW (RGBW: DPT 251.600, HSVW: DPT 5.003, DPT 5.001, DPT 5.001, DPT 5.001)". The value (RGB/HSV) is configured by means of a colour picker. With the data point type value range "colour value RGBW/HSVW (RGBW: DPT 251.600, HSVW: DPT 5.003, DPT 5.001, DPT 5.001, DPT 5.001)", the white value is configured by means of a separate slider.	

White value	0 ... 255
<p>This parameter determines the object value of the white value (W) after the bus voltage returns.</p> <p>It is visible only if "data point type value range = colour value RGBW/HSVW (RGBW: DPT 251.600, HSVW: DPT 5.003, DPT 5.001, DPT 5.001, DPT 5.001)".</p>	
Disabling function	Inactive Active
<p>This parameter enables the disabling function for the channel.</p>	
At the beginning of the disabling function	no reaction Transmit value
<p>Besides disabling the channel, the device can immediately react when the disabling occurs.</p> <p>This parameter defines the reaction of the channel at the beginning of the disabling.</p>	
Value	0 ... 100%
<p>This parameter determines the object value at the beginning of the disabling.</p> <p>It is visible only if "data point type value range = DPT 5.001 0 ... 100%".</p>	
Value	0 ... 255
<p>This parameter determines the object value at the beginning of the disabling.</p> <p>It is visible only if "data point type value range = DPT 5.010 0 ... 255".</p>	
Value	0 ... 360°
<p>This parameter determines the object value at the beginning of the disabling.</p> <p>It is visible only if "data point type value range = DPT 5.003 0 ... 360°".</p>	
Value	0 ... 255%
<p>This parameter determines the object value at the beginning of the disabling.</p> <p>It is visible only if "data point type value range = DPT 5.004 0 ... 255%".</p>	
Value	-128...0 ... 127
<p>This parameter determines the object value at the beginning of the disabling.</p> <p>It is visible only if "data point type value range = DPT 6.010 -128 ... 127".</p>	
Value	0 ... 65535
<p>This parameter determines the object value at the beginning of the disabling.</p> <p>It is visible only if "data point type value range = DPT 7.001 0 ... 65535".</p>	
Colour temperature value	1000 ... 2700 ... 10000 K
<p>This parameter determines the object value at the beginning of the disabling.</p> <p>It is visible only if "data point type value range = DPT 7.600 1000 ... 10000 K".</p>	

Value	-32768 ... 0 ... 32767
This parameter determines the object value at the beginning of the disabling. It is visible only if "data point type value range = DPT 8.001 -32768 ... 32767".	
Temperature value	0 ... 20 ... 40°C
This parameter determines the object value at the beginning of the disabling. It is visible only if "data point type value range = DPT 9.001 0 ... 40°C".	
Brightness value	0, 50 ... 300 ... 1500 lux
This parameter determines the object value at the beginning of the disabling. It is visible only if "data point type value range = DPT 9.004 0 ... 1500 lux".	
Colour temperature value	1000 ... 2700 ... 10000 K
This parameter determines the object value at the beginning of the disabling. It is visible only if "data point type value range = DPT 249.600 colour temperature value + brightness".	
Brightness value	0 ... 100%
This parameter determines the object value at the beginning of the disabling. It is visible only if "data point type value range = DPT 249.600 colour temperature value + brightness".	
Adjustment duration in the actuator	0 ... 100 min, 0, 1 ... 59 s, 0 ... 900 ms
This parameter determines the object value at the beginning of the disabling. It is visible only if "data point type value range = DPT 249.600 colour temperature value + brightness".	
Colour value	#000000 ... #FFFFFF
This parameter determines the object values of the 3-byte value transmitter (or 6-byte value transmitter), brightness value (V), saturation (S) and colour hue (H) objects at the beginning of the disabling. It is visible with "data point type value range = RGB/HSV with colour wheel sequence (RGB: DPT 232.600, HSV: DPT 5.003, DPT 5.001, DPT 5.001)", "data point type value range = RGB/HSV with brightness adjustment (RGB: DPT 232.600, HSV: DPT 5.003, DPT 5.001, DPT 5.001)" and "data point type value range = colour value RGBW/HSVW (RGBW: DPT 251.600, HSVW: DPT 5.003, DPT 5.001, DPT 5.001, DPT 5.001, DPT 5.001)". The value (RGB/HSV) is configured by means of a colour picker. With the data point type value range "colour value RGBW/HSVW (RGBW: DPT 251.600, HSVW: DPT 5.003, DPT 5.001, DPT 5.001, DPT 5.001)", the white value is configured by means of a separate slider.	

White value	0 ... 255
<p>This parameter determines the object value of the white value (W) object at the beginning of the disabling.</p> <p>It is visible only if "data point type value range = colour value RGBW/HSVW (RGBW: DPT 251.600, HSVW: DPT 5.003, DPT 5.001, DPT 5.001, DPT 5.001)".</p>	
At the end of the disabling function	no reaction Transmit current state Transmit value
<p>Besides disabling the channel, the device can immediately react at the end of the disabling.</p> <p>This parameter defines the reaction of the channel at the end of the disabling.</p>	
Value	0 ... 100%
<p>This parameter determines the object value at the end of the disabling.</p> <p>It is visible only if "data point type value range = DPT 5.001 0 ... 100%".</p>	
Value	0 ... 255
<p>This parameter determines the object value at the end of the disabling.</p> <p>It is visible only if "data point type value range = DPT 5.010 0 ... 255".</p>	
Value	0 ... 360°
<p>This parameter determines the object value at the end of the disabling.</p> <p>It is visible only if "data point type value range = DPT 5.003 0 ... 360°".</p>	
Value	0 ... 255%
<p>This parameter determines the object value at the end of the disabling.</p> <p>It is visible only if "data point type value range = DPT 5.004 0 ... 255%".</p>	
Value	-128...0 ...127
<p>This parameter determines the object value at the end of the disabling.</p> <p>It is visible only if "data point type value range = DPT 6.010 -128 ... 127".</p>	
Value	0 ... 65535
<p>This parameter determines the object value at the end of the disabling.</p> <p>It is visible only if "data point type value range = DPT 7.001 0 ... 65535".</p>	
Colour temperature value	1000 ... 2700 ... 10000 K
<p>This parameter determines the object value at the end of the disabling.</p> <p>It is visible only if "data point type value range = DPT 7.600 1000 ... 10000 K".</p>	

Value	-32768 ... 0 ... 32767
This parameter determines the object value at the end of the disabling. It is visible only if "data point type value range = DPT 8.001 -32768 ... 32767".	
Temperature value	0 ... 20 ... 40°C
This parameter determines the object value at the end of the disabling. It is visible only if "data point type value range = DPT 9.001 0 ... 40°C".	
Brightness value	0, 50 ... 300 ... 1500 lux
This parameter determines the object value at the end of the disabling. It is visible only if "data point type value range = DPT 9.004 0 ... 1500 lux".	
Colour temperature value	1000 ... 2700 ... 10000 K
This parameter determines the object value at the end of the disabling. It is visible only if "data point type value range = DPT 249.600 colour temperature value + brightness".	
Brightness value	0 ... 100%
This parameter determines the object value at the end of the disabling. It is visible only if "data point type value range = DPT 249.600 colour temperature value + brightness".	
Adjustment duration in the actuator	0 ... 100 min, 0, 1 ... 59 s, 0 ... 900 ms
This parameter determines the object value at the end of the disabling. It is visible only if "data point type value range = DPT 249.600 colour temperature value + brightness".	
Colour value	#000000 ... #FFFFFF
This parameter determines the object values of the 3-byte value transmitter (or 6-byte value transmitter), brightness value (V), saturation (S) and colour hue (H) objects at the end of the disabling. It is visible with "data point type value range = RGB/HSV with colour wheel sequence (RGB: DPT 232.600, HSV: DPT 5.003, DPT 5.001, DPT 5.001)", "data point type value range = RGB/HSV with brightness adjustment (RGB: DPT 232.600, HSV: DPT 5.003, DPT 5.001, DPT 5.001)" and "data point type value range = colour value RGBW/HSVW (RGBW: DPT 251.600, HSVW: DPT 5.003, DPT 5.001, DPT 5.001, DPT 5.001, DPT 5.001)". The value (RGB/HSV) is configured by means of a colour picker. With the data point type value range "colour value RGBW/HSVW (RGBW: DPT 251.600, HSVW: DPT 5.003, DPT 5.001, DPT 5.001, DPT 5.001)", the white value is configured by means of a separate slider.	

White value	0 ... 255
<p>This parameter determines the object value of the white value (W) object at the end of the disabling.</p> <p>It is visible only if "data point type value range = colour value RGBW/HSVW (RGBW: DPT 251.600, HSVW: DPT 5.003, DPT 5.001, DPT 5.001, DPT 5.001)".</p>	
Object polarity	0 = enabled / 1 = disable 1 = enabled / 0 = disable
<p>This parameter defines the value of the disabling object at which the disabling function is active.</p>	

8.1.6.2 Object list

The following communication objects are available in the "push-button" channel function with the parameterised "value transmitter" function. The name can be adjusted with the "Name" parameter.

Object no.	Function	Name	Type	DPT	Flag
397, 421, ..., 565	Value transmitter - 0...100%	K <i>n</i> - Output	1-byte	5,001	C, R, -, T, A
1-byte object for the transmission of values from 0 to 100%.					
<p>i These objects are visible only if "data point type value range = DPT 5.001 0 ... 100%".</p>					

Object no.	Function	Name	Type	DPT	Flag
397, 421, ..., 565	Value transmitter - 0...255	K <i>n</i> - Output	1-byte	5,010	C, R, -, T, A
1-byte object for the transmission of values from 0 to 255.					
<p>i These objects are visible only if "data point type value range = DPT 5.010 0 ... 255".</p>					

Object no.	Function	Name	Type	DPT	Flag
397, 421, ..., 565	Value transmitter - 0...360°	K <i>n</i> - Output	1-byte	5,003	C, R, -, T, A
1-byte object for the transmission of values from 0 to 360°.					
<p>i These objects are visible only if "data point type value range = DPT 5.003 0 ... 360°".</p>					

Object no.	Function	Name	Type	DPT	Flag
397, 421, ..., 565	Value transmitter - 0...255%	K <i>n</i> - Output	1-byte	5,004	C, R, -, T, A
1-byte object for the transmission of values from 0 to 255%.					
<p>i These objects are visible only if "data point type value range = DPT 5.004 0 ... 255%".</p>					

Object no.	Function	Name	Type	DPT	Flag
397, 421, ..., 565	Value transmitter - -128...127	K <i>n</i> - Output	1-byte	6,010	C, R, -, T, A
1-byte object for the transmission of values from -128 to 127.					
<p>i These objects are visible only if "data point type value range = DPT 6.010 -128 ... 127".</p>					

Object no.	Function	Name	Type	DPT	Flag
397, 421, ..., 565	Value transmitter - 0...65535	K <i>n</i> - Output	2-byte	7,001	C, R, -, T, A
2-byte object for the transmission of values from 0 to 65535.					
<p>i These objects are visible only if "data point type value range = DPT 7.001 0 ... 65535".</p>					

Object no.	Function	Name	Type	DPT	Flag
397, 421, ..., 565	Value transmitter - Colour temperature value	K <i>n</i> - Output	2-byte	7,600	C, R, -, T, A
2-byte object for transmitting colour temperatures from 1000 to 10000 Kelvin.					
<p>i These objects are visible only if "data point type value range = DPT 7.600 1000 ... 10000 K".</p>					

Object no.	Function	Name	Type	DPT	Flag
397, 421, ..., 565	Value transmitter - -32768...32767	K <i>n</i> - Output	2-byte	8,001	C, R, -, T, A
2-byte object for the transmission of values from -32768 to 32767.					
<p>i These objects are visible only if "data point type value range = DPT 8.001 -32768 ... 32767".</p>					

Object no.	Function	Name	Type	DPT	Flag
397, 421, ..., 565	Value transmitter - Temperature value	K <i>n</i> - Output	2-byte	9,001	C, R, -, T, A
2-byte object for transmitting temperature values from 0 to 40 °C.					
<p>i These objects are visible only if "data point type value range = DPT 9.001 0 ... 40°C".</p>					

Object no.	Function	Name	Type	DPT	Flag
397, 421, ..., 565	Value transmitter - Brightness value	K <i>n</i> - Output	2-byte	9,004	C, R, -, T, A
2-byte object for transmitting brightness values from 0 to 1500 Lux.					
<p>i These objects are visible only if "data point type value range = DPT 9.004 0 ... 1500 lux".</p>					

Object no.	Function	Name	Type	DPT	Flag
397, 421, ..., 565	Value transmitter - Colour temperature value and brightness value	K <i>n</i> - Output	6-byte	249,600	C, R, -, T, A
<p>6-byte object used to transmit a colour temperature value, a brightness value and the adjustment time in the actuator. The actuator sets the received values during the adjustment time.</p> <p>i These objects are visible only if "data point type value range = DPT 249.600 colour temperature value + brightness" applies.</p>					
Object no.	Function	Name	Type	DPT	Flag
397, 421, ..., 565	Value transmitter - RGB/HSV (colour wheel sequence)	K <i>n</i> - Output	3-byte	232,600	C, R, -, T, A
<p>3-byte object for transmitting 3-byte colour information.</p> <p>i These objects are visible only if "data point type value range = RGB/HSV with colour wheel sequence (RGB: DPT 232.600, HSV: DPT 5.003, DPT 5.001, DPT 5.001)".</p>					
Object no.	Function	Name	Type	DPT	Flag
397, 421, ..., 565	Value transmitter - RGB/HSV (brightness adjustment)	K <i>n</i> - Output	3-byte	232,600	C, R, -, T, A
<p>3-byte object for transmitting 3-byte colour information.</p> <p>i These objects are visible only with data point type value range: RGB/HSV with brightness adjustment (RGB: DPT 232.600, HSV: DPT 5.003, DPT 5.001, DPT 5.001).</p>					
Object no.	Function	Name	Type	DPT	Flag
397, 421, ..., 565	Value transmitter - RGBW	K <i>n</i> - Output	6-byte	251,600	C, R, -, T, A
<p>6-byte object for transmitting 6-byte colour information.</p> <p>i These objects are visible only with data point type value range: colour value RGBW/HSVW (RGBW: DPT 251.600, HSVW: DPT 5.003, DPT 5.001, DPT 5.001, DPT 5.001).</p>					

Object no.	Function	Name	Type	DPT	Flag
398, 422, ..., 566	Value transmitter - Colour hue (H)	K <i>n</i> - Output	1-byte	5,003	C, R, -, T, A

1-byte object for transmitting the colour hue.

- i** These objects are visible only with data point type | value range:
- RGB/HSV with colour wheel sequence (RGB: DPT 232.600, HSV: DPT 5.003, DPT 5.001, DPT 5.001)
 - RGB/HSV with brightness adjustment (RGB: DPT 232.600, HSV: DPT 5.003, DPT 5.001, DPT 5.001)
 - Colour value RGBW/HSVW (RGBW: DPT 251.600, HSVW: DPT 5.003, DPT 5.001, DPT 5.001, DPT 5.001)

Object no.	Function	Name	Type	DPT	Flag
399, 423, ..., 567	Value transmitter - Saturation (S)	K <i>n</i> - Output	1-byte	5,001	C, R, -, T, A

1-byte object for transmitting the saturation.

- i** These objects are visible only with data point type | value range:
- RGB/HSV with colour wheel sequence (RGB: DPT 232.600, HSV: DPT 5.003, DPT 5.001, DPT 5.001)
 - RGB/HSV with brightness adjustment (RGB: DPT 232.600, HSV: DPT 5.003, DPT 5.001, DPT 5.001)
 - Colour value RGBW/HSVW (RGBW: DPT 251.600, HSVW: DPT 5.003, DPT 5.001, DPT 5.001, DPT 5.001)

Object no.	Function	Name	Type	DPT	Flag
400, 424, ..., 568	Value transmitter - brightness value (V)	K <i>n</i> - Output	1-byte	5,001	C, R, -, T, A

1-byte object for transmitting the brightness value.

- i** These objects are visible only with data point type | value range:
- RGB/HSV with colour wheel sequence (RGB: DPT 232.600, HSV: DPT 5.003, DPT 5.001, DPT 5.001)
 - RGB/HSV with brightness adjustment (RGB: DPT 232.600, HSV: DPT 5.003, DPT 5.001, DPT 5.001)
 - Colour value RGBW/HSVW (RGBW: DPT 251.600, HSVW: DPT 5.003, DPT 5.001, DPT 5.001, DPT 5.001)

Object no.	Function	Name	Type	DPT	Flag
401, 425, ..., 569	Value transmitter - White value (W)	K n - Output	1-byte	5,001	C, R, -, T, A
1-byte object for transmitting the white level.					
<p>i These objects are visible only with data point type value range: colour value RGBW/HSVW (RGBW: DPT 251.600, HSVW: DPT 5.003, DPT 5.001, DPT 5.001, DPT 5.001).</p>					
Object no.	Function	Name	Type	DPT	Flag
403, 427, ..., 571	Value transmitter - Brightness value (V) - Status	K n - Input	1-byte	5,001	C, -, W, -, U
1-byte object for receiving the brightness value.					
<p>i These objects are only visible with the following configuration:</p> <ul style="list-style-type: none"> - Data point type value range: RGB/HSV with brightness adjustment (RGB: DPT 232.600, HSV: DPT 5.003, DPT 5.001, DPT 5.001) - "Start value" parameter = as value from brightness (V) status object 					
Object no.	Function	Name	Type	DPT	Flag
403, 427, ..., 571	Value transmitter - Colour hue (H) - Status	K n - Input	1-byte	5,003	C, -, W, -, U
1-byte object for receiving the colour hue.					
<p>i These objects are only visible with the following configuration:</p> <ul style="list-style-type: none"> - Data point type value range: RGB/HSV with colour wheel sequence (RGB: DPT 232.600, HSV: DPT 5.003, DPT 5.001, DPT 5.001) - "Start value" parameter = as value from colour hue (H) status object 					
Object no.	Function	Name	Type	DPT	Flag
403, 427, ..., 571	Value transmitter - RGB - Status	K n - Input	3-byte	232,600	C, -, W, -, U
3-byte object for receiving 3-byte colour information.					
<p>i These objects are only visible with the following configuration:</p> <ul style="list-style-type: none"> - Parameter: data point type value range: RGB/HSV with brightness adjustment (RGB: DPT 232.600, HSV: DPT 5.003, DPT 5.001, DPT 5.001), RGB/HSV with colour wheel sequence (RGB: DPT 232.600, HSV: DPT 5.003, DPT 5.001, DPT 5.001). - "Start value" parameter = as value from RGB status object 					

Object no.	Function	Name	Type	DPT	Flag
408, 432, ..., 576	Value transmitter - Disabling	K <i>n</i> - Input	1-bit	1,003	C, -, W, -, U
1-bit object for activating or deactivating the disabling function. The object polarity can be parameterised.					

8.1.7 Scene extension

In the "push-button" channel function, the push-button can be parameterised for the "scene extension" function. The ETS indicates up to two communication objects for the "scene extension" function. The parameters can be used to determine the value the "scene extension" object obtains when the button is pressed. Furthermore, the behaviour of the channel after the bus voltage returns can be parameterised and a disabling function activated.

In the scene extension function, the device calls either a parameterised scene number (1...64) or switches between two scenes if the button is briefly pressed. This makes it possible to recall scenes stored in other devices. Optionally, the channel performs a storage function if the button is pressed for a long time.

Setting options when button is pressed briefly:

- Recall scene: results in simply recalling the scene.
- Switch over scene: The input option for a second scene number (1...64) appears. The two entered scene numbers are switched to and from each time the button is briefly pressed.

Setting options when button is pressed and held:

- No reaction
- Storage function: A storage command is generated by actuating the button for more than five seconds. In the scene extension function, a storage telegram is in this case transmitted to the bus. The internal scene is stored. The internal scene control module will then request the current scene values for the actuator groups used from the bus.

i A button actuation lasting between one and five seconds will be discarded as invalid.

8.1.7.1 Table of parameters

The following parameters are available in the "push-button" channel function with the parameterised "scene extension" function.

Short button actuation	Recall scene Switch over scene
<p>This parameter defines the functionality of the scene extension.</p> <p>If the device is used as a scene extension, the scenes can either be stored in one or several other KNX devices (e.g. light scene push button sensor). When a scene is recalled, the device transmits a telegram with the respective scene number via the extension object of the button.</p>	
Scene number	1...64
<p>In accordance with the KNX standard, objects with data type 18.001 "Scene Control" can retrieve or store up to 64 scenes by their numbers. The parameter defines the scene number to be transmitted when the button is pressed.</p> <p>The input of the scene number is available only if "Call scene" is active in the event of the "short button actuation" command.</p>	
First scene number	1...64
<p>In accordance with the KNX standard, objects with data type 18.001 "Scene Control" can retrieve or store up to 64 scenes by their numbers. The parameter defines the scene number to be transmitted when the button is pressed.</p> <p>The input of the first scene number is available only if "Switch over scene" is active in the event of the "short button actuation" command.</p>	
Second scene number	1, 2 ... 64
<p>In accordance with the KNX standard, objects with data type 18.001 "Scene Control" can retrieve or store up to 64 scenes by their numbers. The parameter defines the scene number to be transmitted when the button is pressed.</p> <p>The input of the second scene number is available only if "Switch over scene" is active in the event of the "short button actuation" command.</p>	
Long button actuation	No reaction Memory function
<p>This parameter defines the functionality of the scene extension.</p> <p>If the device is used as a scene extension, the scenes can either be stored in one or several other KNX devices (e.g. light scene push button sensor). With activated storage function, the device transmits a telegram with the respective scene number via the extension object of the button.</p>	

After bus voltage return	no reaction Transmit current state Recall scene
<p>This parameter determines the reaction after the bus voltage returns.</p> <p>Either no telegram, a telegram according to the current input state at the channel or a parameterised scene number is transmitted on the bus according to the parameterisation.</p> <p>The reaction after the bus voltage returns takes place only after the parameterised "delay after bus voltage returns" expires ("General" parameter page).</p>	
Scene number	1...64
<p>The parameter defines here the scene number to be transmitted after the bus voltage returns.</p>	
Disabling function	Inactive Active
<p>This parameter enables the disabling function for the channel.</p>	
At the beginning of the disabling function	no reaction Recall scene
<p>Besides disabling the channel, the device can immediately react when the disabling occurs.</p> <p>This parameter defines the reaction of the channel at the beginning of the disabling.</p>	
Scene number	1...64
<p>The scene number to be transmitted at the beginning of the disabling is defined here.</p>	
At the end of the disabling function	no reaction Transmit current state Recall scene
<p>Besides disabling the channel, the device can immediately react at the end of the disabling.</p> <p>This parameter defines the reaction of the channel at the end of the disabling.</p>	
Scene number	1...64
<p>The scene number to be transmitted at the end of the disabling is defined here.</p>	
Object polarity	0 = enabled / 1 = disable 1 = enabled / 0 = disable
<p>This parameter defines the value of the disabling object at which the disabling function is active.</p>	

8.1.7.2 Object list

The following communication objects are available in the "push-button" channel function with the parameterised "scene extension" function. The name can be adjusted with the "Name" parameter.

Object no.	Function	Name	Type	DPT	Flag
590, 598, ..., 646	Scene extension - Scene number	K <i>n</i> - Output	1-byte	18,001	C, R, -, T, A
1-byte object for recalling, switching over or storing one of a maximum of 64 scenes at a scene push-button sensor.					

Object no.	Function	Name	Type	DPT	Flag
591, 599, ..., 647	Scene extension - Disabling	K <i>n</i> - Input	1-bit	1,003	C, -, W, -, U
1-bit object for activating or deactivating the disabling function. The object polarity can be parameterised.					

8.1.8 Short and long button actuation

- i** The "short and long button actuation" function replaces the "2-channel operation" function.

In the "push-button" channel function, the push-button can be parameterised for the "short and long button actuation" function. The ETS indicates up to nine communication objects for each channel for the "short and long button actuation" function. The parameters can be used to determine the values the "short and long button actuation" objects obtain when the button is pressed. Furthermore, the behaviour of the channel after the bus voltage returns can be parameterised and a disabling function activated.

The "short and long button actuation" function allows two objects to be operated with one push-button. Two different functions can be configured to transmit different telegrams.

The following functions are available:

- DPT 1.001 | Switching
- DPT 2.001 | Forced position
- DPT 5.001 | 0 ... 100%
- DPT 5.010 | 0 ... 255
- DPT 5.003 | 0 ... 360°
- DPT 5.004 | 0 ... 255%
- DPT 6.010 | -128 ... 127
- DPT 7.001 | 0 ... 65535
- DPT 8.001 | -32768 ... 32767
- DPT 9.001 | 0 ... 40°C
- DPT 9.004 | 0 ... 1500 lux
- DPT 18.001 | Call up scene (externally)
- DPT 18.001 | Switch scene (external)
- Room temperature control point
- RGB/HSV (RGB: DPT 232.600, HSV: DPT 5.003, DPT 5.001, DPT 5.001)
- RGBW/HSVW (RGBW: DPT 251.600, HSVW: DPT 5.003, DPT 5.001, DPT 5.001, DPT 5.001)

The object value that the device is to transmit on a button actuation can be selected depending on the selected function.

Transmission behaviour, long button actuation = object 2

With this transmission behaviour, exactly one telegram is sent each time the button is pressed.

- The device sends the telegram for object 1 if the button is pressed briefly.
- The device sends the telegram for object 2 if the button is pressed longer.

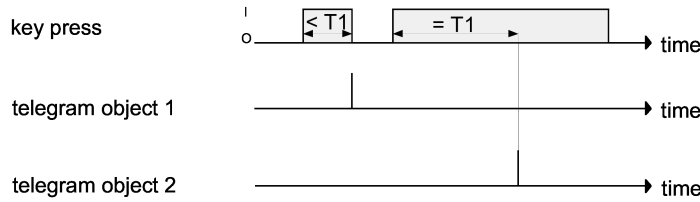

T1 = time between object 1 and object 2

Figure 14: Example of "object 1 or object 2" operating concept

The "Long button actuation from" parameter defines the time period for distinguishing between short-time and long-time operation. If the push-button is pressed for shorter than the parameterised time, only the telegram for object 1 is transmitted on the bus. If the "long button actuation" time is exceeded by the actuation period, only the telegram for object 2 is transmitted on the bus.

i The device does not directly transmit a telegram on the bus.

Transmission behaviour, long button actuation = object 1 and object 2

With this transmission behaviour, one or alternatively two telegrams can be transmitted each time the button is pressed.

- The device will send the telegram for object 1 if the button is pressed briefly.
- The device will send the telegram for object 1 and then the telegram for object 2 if the button is pressed longer.

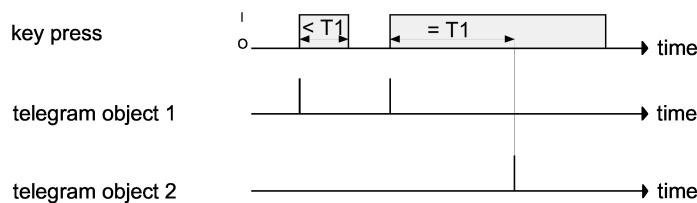

T1 = time between object 1 and object 2

Figure 15: Example of "object 1 and object 2" operating concept

The "Long button actuation from" parameter defines the time period for distinguishing between short-time and long-time operation. The telegram for object 1 is immediately transmitted on the bus if the button is pressed. If the push-button remains pressed for the parameterised time, the telegram for object 2 is also transmitted on the bus. If the push-button is released before the time expires, no further telegram is transmitted on the bus.

i The "long button actuation from" time is to be parameterised for a sufficient period, depending on the application case, to prevent simultaneous transmission of the objects.

8.1.8.1 Table of parameters

The following parameters are available in the "push-button" channel function with the parameterised "short and long button actuation" function.

Short button actuation (object 1)	No function DPT 1.001 Switching DPT 2.001 Forced position DPT 5.001 0 ... 100% DPT 5.010 0 ... 255 DPT 5.003 0 ... 360° DPT 5.004 0 ... 255% DPT 6.010 -128 ... 127 DPT 7.001 0 ... 65535 DPT 7.006 1000 ... 10000 K DPT 8.001 -32768 ... 32767 DPT 9.001 0 ... 40°C DPT 9.004 0 ... 1500 lux DPT 18.001 Call up scene (externally) DPT 18.001 Switch scene (external) DPT 249.600 Colour temperature value + brightness Room temperature control point RGB/HSV (RGB: DPT 232.600, HSV: DPT 5.003, DPT 5.001, DPT 5.001) RGBW/HSVW (RGBW: DPT 251.600, HSVW: DPT 5.003, DPT 5.001, DPT 5.001, DPT 5.001)
-----------------------------------	---

This parameter determines the function of the short button actuation and defines the other parameters and communication objects to be displayed.

Function	Operating mode switchover Forced oper. mode switchover Presence function Target temperature shift
----------	---

A room temperature control point can optionally switch over (force) the operating mode with normal or high priority, change the presence status or change the current room temperature setpoint value.

Visible only if "short button actuation (object 1) = room temperature control point".

Target temperature shift	By relative temperature value By meter value
Depending on the setting of the "Target temperature shift" parameter, the shift takes place by means of the 2-byte communication object in accordance with KNX DPT 9.002 or KNX DPT 6.010. Visible only if "functionality = setpoint temperature shift".	
Long button actuation (object 2)	No function DPT 1.001 Switching DPT 2.001 Forced position DPT 5.001 0 ... 100% DPT 5.010 0 ... 255 DPT 5.003 0 ... 360° DPT 5.004 0 ... 255% DPT 6.010 -128 ... 127 DPT 7.001 0 ... 65535 DPT 7.006 1000 ... 10000 K DPT 8.001 -32768 ... 32767 DPT 9.001 0 ... 40°C DPT 9.004 0 ... 1500 lux DPT 18.001 Call up scene (externally) DPT 18.001 Switch scene (external) DPT 249.600 Colour temperature value + brightness Room temperature control point RGB/HSV (RGB: DPT 232.600, HSV: DPT 5.003, DPT 5.001, DPT 5.001) RGBW/HSVW (RGBW: DPT 251.600, HSVW: DPT 5.003, DPT 5.001, DPT 5.001, DPT 5.001)
This parameter determines the function of the long button actuation and defines the other parameters and communication objects to be displayed.	
Function	Operating mode switchover Forced oper. mode switchover Presence function Target temperature shift
A room temperature control point can optionally switch over (force) the operating mode with normal or high priority, change the presence status or change the current room temperature setpoint value. Visible only if "long button actuation (object 2) = room temperature control point".	

Target temperature shift	By relative temperature value By meter value
Depending on the setting of the "Target temperature shift" parameter, the shift takes place by means of the 2-byte communication object in accordance with KNX DPT 9.002 or KNX DPT 6.010. Visible only if "functionality = setpoint temperature shift".	
Short button actuation (object 1) Long button actuation (object 2)	ON OFF TOGGLE
This parameter defines the object value transmitted to the bus when the button is pressed. It is visible only if "function = DPT 1.001 switching".	
Short button actuation (object 1) Long button actuation (object 2)	no reaction Forcing active, ON Forcing active, OFF Forcing inactive
This parameter defines the object value transmitted to the bus when the button is pressed. It is visible only if "functionality = DPT 2.001 forced position".	
Short button actuation (object 1) Long button actuation (object 2) Value	0...100 %
This parameter defines the object value transmitted to the bus when the button is pressed. It is visible only if "function = DPT 5.001 0 ... 100%".	
Short button actuation (object 1) Long button actuation (object 2) Value	0...255
This parameter defines the object value transmitted to the bus when the button is pressed. It is visible only if "function = DPT 5.010 0 ... 255".	
Short button actuation (object 1) Long button actuation (object 2) Value	0...360°
This parameter defines the object value transmitted to the bus when the button is pressed. It is visible only if "function = DPT 5.003 0 ... 360°".	

Short button actuation (object 1) Long button actuation (object 2) Value	0...255 %
This parameter defines the object value transmitted to the bus when the button is pressed. It is visible only if "function = DPT 5.004 0 ... 255%".	
Short button actuation (object 1) Long button actuation (object 2) Value	-128...0...127
This parameter defines the object value transmitted to the bus when the button is pressed. It is visible only if "function = DPT 6.010 -128 ... 127".	
Short button actuation (object 1) Long button actuation (object 2) Value	0...65535
This parameter defines the object value transmitted to the bus when the button is pressed. It is visible only if "function = DPT 7.001 0 ... 65535".	
Short button actuation (object 1) Long button actuation (object 2) Value	1000...2700...10000 K
This parameter defines the object value transmitted to the bus when the button is pressed. It is visible only if "functionality = DPT 7.600 1000 ... 10000 K".	
Short button actuation (object 1) Long button actuation (object 2) Value	-32768...0...32767
This parameter defines the object value transmitted to the bus when the button is pressed. It is visible only if "function = DPT 8.001 -32768 ... 32767".	
Short button actuation (object 1) Long button actuation (object 2) Temperature value	0...20...40°C
This parameter defines the object value transmitted to the bus when the button is pressed. It is visible only if "function = DPT 9.001 0 ... 40°C".	

Short button actuation (object 1) Long button actuation (object 2) Brightness value	0... 300 ...1500 lux
This parameter defines the object value transmitted to the bus when the button is pressed. It is visible only if "function of object 1 (2) = DPT 9.004 0 ... 1500 lux".	
Short button actuation (object 1) Long button actuation (object 2) Scene number	1 ...64
This parameter defines the object value transmitted to the bus when the button is pressed. It is visible only if "function = DPT 18.001 Recall scene (externally)".	
Short button actuation (object 1) Long button actuation (object 2) First scene number	1 ...64
This parameter defines the object value transmitted to the bus when the button is pressed. It is visible only if "functionality = DPT 18.001 Switch over scene (externally)".	
Short button actuation (object 1) Long button actuation (object 2) Second scene number	1 ... 2 ...64
This parameter defines the object value transmitted to the bus when the button is pressed. It is visible only if "functionality = DPT 18.001 Switch over scene (externally)".	
Short button actuation (object 1) Long button actuation (object 2) Colour temperature value	1000 ... 2700 ... 10000 K
This parameter defines the object value when the button is pressed. It is visible only if "functionality = DPT 249.600 colour temperature value + brightness".	
Short button actuation (object 1) Long button actuation (object 2) Brightness value	0 ... 100 %
This parameter defines the object value when the button is pressed. It is visible only if "functionality = DPT 249.600 colour temperature value + brightness".	

Short button actuation (object 1) Long button actuation (object 2) Adjustment duration in the actuator	0 ... 100 min, 0, 1 ... 59 s, 0 ... 900 ms
This parameter defines the object value when the button is pressed. It is visible only if "functionality = DPT 249.600 colour temperature value + brightness".	
Short button actuation (object 1) Long button actuation (object 2) Operating mode	Comfort Standby Night Frost/heat protection Switchover: comfort/standby Switchover: comfort/night Switchover: standby/night Switchover: comfort/standby/night
If the room temperature control point is intended to change over the operating mode of the room temperature controller with normal priority, the extension can either switch on a defined operating mode or switch between different operating modes when operated. Visible only if "functionality = room temperature control point -> operating mode change-over".	
Short button actuation (object 1) Long button actuation (object 2) Forced operating mode	Forcing inactive (auto) Comfort Standby Night Frost/heat protection Switchover: comfort/standby Switchover: comfort/night Switchover: standby/night Switchover: comfort/standby/night Toggle: forced inactive (auto) / comfort Toggle: forced inactive (auto) / standby Toggle: forced inactive (auto) / night Switchover: forced inactive (auto) / frost/heat protection
If the room temperature control point is intended to switch the operating mode of the room temperature controller with high priority, the extension can either enable change-over with normal priority (auto), switch on a defined operating mode with high priority or switch different operating modes when operated. Visible only if "functionality = room temperature control point -> forced operating mode change-over".	

Short button actuation (object 1)	Presence ON
Long button actuation (object 2)	Presence OFF
	Presence TOGGLE

The room temperature control point can switch the presence state of the room temperature controller either on or off in a defined way or the extension can switch between both states ("Presence TOGGLE") by pressing the button.

Visible only if "functionality = room temperature control point -> presence function".

Short button actuation (object 1)	+2 K
Long button actuation (object 2)	+1.5 K
Target temperature shift	+1 K
	+0.5 K
	-0.5 K
	-1 K
	-1.5 K
	-2 K

The temperature difference is defined in Kelvin here by which the setpoint temperature will be shifted up or down when the button is pressed.

To shift the setpoint temperature, the room temperature control point uses the two communication objects "Setpoint temperature shift" and "Setpoint temperature shift - Status".

The communication object "Setpoint temperature shift - Status" informs the room temperature control point about the current state of the room temperature controller. Based on this value and the parameter here, the room temperature control point calculates the new level value, which it transmits to the room temperature controller by means of the "setpoint temperature shift" communication object.

Visible only if "Functionality = room temperature control point -> Setpoint temperature shift -> By relative temperature value".

Short button actuation (object 1)	Increase setpoint temperature
Long button actuation (object 2)	Reduce setpoint temperature

The direction of the target temperature shift is defined here at the room temperature control point.

To shift the setpoint temperature, the room temperature control point uses the two communication objects "Setpoint temperature shift" and "Setpoint temperature shift - Status".

The communication object "Setpoint temperature shift - Status" informs the extension about the current state of the room temperature controller. Based on this value and the parameter here, the room temperature control point calculates the new level value, which it transmits to the room temperature controller by means of the "setpoint temperature shift" communication object.

Visible only if "Functionality = room temperature control point -> Setpoint temperature shift -> By counting value".

Short button actuation (object 1) Long button actuation (object 2) Colour value	#000000 ... #FFFFFF
<p>This parameter determines the object values of the colour hue (H), saturation (S), brightness value (V), which is transmitted to the bus when the button is pressed. It is visible if "function = RGB/HSV (RGB: DPT 232.600, HSV: DPT 5.003, DPT 5.001, DPT 5.001)".</p>	
Short button actuation (object 1) Long button actuation (object 2) White value	0 ... 255
<p>This parameter defines the object value of the white level (W) object when the button is pressed. It is visible only if "function = RGBW/HSVW (RGBW: DPT 251.600, HSVW: DPT 5.003, DPT 5.001, DPT 5.001, DPT 5.001)".</p>	
Advanced parameters	Active Inactive
<p>This parameter enables advanced configuration options for the "short and long button actuation" function.</p> <p>If the advanced parameters are deactivated, the device transmits object 1 if the button is pressed briefly and object 2 if it is pressed for a long period. Pressing the button for at least 3 seconds is regarded as long.</p> <p>When the advanced parameters are activated, the ETS shows the following parameters.</p>	
Transmission behaviour, long button actuation	Object 2 Object 1 and object 2
<p>This parameter defines the transmission behaviour of long button actuation.</p> <p>Object 2: object 1 is transmitted by pressing the button briefly and object 2 is transmitted by pressing the button for a long period</p> <p>Object 1 and object 2: object 1 is transmitted by pressing the button briefly and object 1 and object 2 are transmitted by pressing the button for a long period</p>	
Long button actuation from	0...3...25 s 0...990 ms
<p>This parameter defines the interval at which the device transmits the telegram for object 1 and the telegram for object 2, depending on the selected transmission behaviour. A time from 100 ms to 25.5 s can be set.</p> <p> The "long button actuation from" time is to be parameterised for a sufficient period, depending on the application case, to prevent simultaneous transmission of the objects.</p>	

After bus voltage return Object 1 (object 2)	no reaction Transmit value
<p>This parameter determines the reaction after the bus voltage returns.</p> <p>Either no telegram or a value parameterised according to the functionality is transmitted on the bus according to the parameterisation.</p> <p>The reaction after the bus voltage returns takes place only after the parameterised "delay after bus voltage returns" expires ("General" parameter page).</p>	
Disabling function	Inactive Active
<p>This parameter enables the disabling function for the channel.</p>	
At the beginning of the disabling function Object 1 (object 2)	no reaction Transmit value
<p>Besides disabling the channel, the device can immediately react when the disabling occurs.</p> <p>Either no telegram or a value parameterised according to the functionality is transmitted on the bus according to the parameterisation.</p> <p>This parameter defines the reaction of the channel at the beginning of the disabling.</p>	
At the end of the disabling function Object 1 (object 2)	no reaction Transmit value
<p>Besides disabling the channel, the device can immediately react at the end of the disabling.</p> <p>Either no telegram or a value parameterised according to the functionality is transmitted on the bus according to the parameterisation.</p> <p>This parameter defines the reaction of the channel at the end of the disabling.</p>	
Object polarity	0 = enabled / 1 = disable 1 = enabled / 0 = disable
<p>This parameter defines the value of the disabling object at which the disabling function is active.</p>	

8.1.8.2 Object list

The following communication objects are available in the "push-button" channel function with the parameterised "short and long button actuation" function. The name can be adjusted with the "Name" parameter.

Object no.	Function	Name	Type	DPT	Flag
653, 669 ..., 765	Short and long button actuation - Object 1 - Switching	K n - Output	1-bit	1,001	C, R, -, T, A
1-bit object to send switching telegrams if the button is briefly pressed (object 1).					

Object no.	Function	Name	Type	DPT	Flag
654, 670, ..., 766	Short and long button actuation - Object 2 - Switching	K n - Output	1-bit	1,001	C, R, -, T, A
1-bit object to send switching telegrams if the button is pressed and held (object 2).					

Object no.	Function	Name	Type	DPT	Flag
665, 681 ..., 777	Short and long button actuation - Object 1 - Switching - Status	K n - Input	1-bit	1,001	C, -, W, -, U
1-bit object for receiving feedback telegrams (ON, OFF) (object 1). This object is visible if the parameter "Short button actuation (object 1)" is parameterised to "TOGGLE".					

Object no.	Function	Name	Type	DPT	Flag
666, 682, ..., 778	Short and long button actuation - Object 2 - Switching - Status	K n - Input	1-bit	1,001	C, -, W, -, U
1-bit object for receiving feedback telegrams (ON, OFF) (object 2). This object is visible if the parameter "Long button actuation (object 2)" is parameterised to "TOGGLE".					

Object no.	Function	Name	Type	DPT	Flag
653, 669 ..., 765	Short and long button actuation - Object 1 - Forced position	K <i>n</i> - Output	2-bit	2,001	C, R, -, T, A

2-bit input object for activating and deactivating the forced position (object 1).

With the value "1", bit 1 of the telegram activates the forced position. The assigned channels are then locked in the state specified by bit 0 ("0" = OFF / "1" = ON). The value "0" in bit 1 deactivates the forced position again.

0x = forcing inactive

10 = forcing active, OFF

11 = forcing active, ON

Object no.	Function	Name	Type	DPT	Flag
654, 670, ..., 766	Short and long button actuation - Object 2 - Forced position	K <i>n</i> - Output	2-bit	2,001	C, R, -, T, A

2-bit input object for activating and deactivating the forced position (object 1).

With the value "1", bit 1 of the telegram activates the forced position. The assigned channels are then locked in the state specified by bit 0 ("0" = OFF / "1" = ON). The value "0" in bit 1 deactivates the forced position again.

0x = forcing inactive

10 = forcing active, OFF

11 = forcing active, ON

Object no.	Function	Name	Type	DPT	Flag
653, 669 ..., 765	Short and long button actuation - Object 1 - Value 0...100%	K <i>n</i> - Output	1-byte	5,001	C, R, -, T, A

1-byte object to send value telegrams if the button is briefly pressed (object 1).

Object no.	Function	Name	Type	DPT	Flag
654, 670, ..., 766	Short and long button actuation - Object 2 - Value 0...100%	K <i>n</i> - Output	1-byte	5,001	C, R, -, T, A

1-byte object to send value telegrams if the button is pressed and held (object 2).

Object no.	Function	Name	Type	DPT	Flag
653, 669 ..., 765	Short and long button actuation - Object 1 - Value 0...255	K n - Output	1-byte	5,010	C, R, -, T, A
1-byte object to send value telegrams if the button is briefly pressed (object 1).					

Object no.	Function	Name	Type	DPT	Flag
654, 670, ..., 766	Short and long button actuation - Object 2 - Value 0...255	K n - Output	1-byte	5,010	C, R, -, T, A
1-byte object to send value telegrams if the button is pressed and held (object 2).					

Object no.	Function	Name	Type	DPT	Flag
653, 669 ..., 765	Short and long button actuation - Object 1 - Value 0...360°	K n - Output	1-byte	5,003	C, R, -, T, A
1-byte object to send value telegrams if the button is briefly pressed (object 1).					

Object no.	Function	Name	Type	DPT	Flag
654, 670, ..., 766	Short and long button actuation - Object 2 - Value 0...360°	K n - Output	1-byte	5,003	C, R, -, T, A
1-byte object to send value telegrams if the button is pressed and held (object 2).					

Object no.	Function	Name	Type	DPT	Flag
653, 669 ..., 765	Short and long button actuation - Object 1 - Value 0...255%	K n - Output	1-byte	5,004	C, R, -, T, A
1-byte object to send value telegrams if the button is briefly pressed (object 1).					

Object no.	Function	Name	Type	DPT	Flag
654, 670, ..., 766	Short and long button actuation - Object 2 - Value 0...255%	K n - Output	1-byte	5,004	C, R, -, T, A
1-byte object to send value telegrams if the button is pressed and held (object 2).					

Object no.	Function	Name	Type	DPT	Flag
653, 669 ..., 765	Short and long button actuation - Object 1 - Value -128...127	K n - Output	1-byte	6,010	C, R, -, T, A
1-byte object to send value telegrams if the button is briefly pressed (object 1).					

Object no.	Function	Name	Type	DPT	Flag
654, 670, ..., 766	Short and long button actuation - Object 2 - Value -128...127	K n - Output	1-byte	6,010	C, R, -, T, A
1-byte object to send value telegrams if the button is pressed and held (object 2).					

Object no.	Function	Name	Type	DPT	Flag
653, 669 ..., 765	Short and long button actuation - Object 1 - Value 0...65535	K n - Output	2-byte	7,001	C, R, -, T, A
2-byte object to send value telegrams if the button is briefly pressed (object 1).					

Object no.	Function	Name	Type	DPT	Flag
654, 670, ..., 766	Short and long button actuation - Object 2 - Value 0...65535	K n - Output	2-byte	7,001	C, R, -, T, A
2-byte object to send value telegrams if the button is pressed and held (object 2).					

Object no.	Function	Name	Type	DPT	Flag
653, 669 ..., 765	Short and long button actuation - Object 1 - Colour temperature value	K n - Output	2-byte	7,600	C, R, -, T, A
2-byte object to send value telegrams if the button is briefly pressed (object 1).					

Object no.	Function	Name	Type	DPT	Flag
654, 670, ..., 766	Short and long button actuation - Object 2 - Colour temperature value	K n - Output	2-byte	7,600	C, R, -, T, A
2-byte object to send value telegrams if the button is pressed and held (object 2).					

Object no.	Function	Name	Type	DPT	Flag
653, 669 ..., 765	Short and long button actuation - Object 1 - Value -32768...32767	K n - Output	2-byte	8,001	C, R, -, T, A
2-byte object to send value telegrams if the button is briefly pressed (object 1).					

Object no.	Function	Name	Type	DPT	Flag
654, 670, ..., 766	Short and long button actuation - Object 2 - Value -32768...32767	K n - Output	2-byte	8,001	C, R, -, T, A
2-byte object to send value telegrams if the button is pressed and held (object 2).					

Object no.	Function	Name	Type	DPT	Flag
653, 669 ..., 765	Short and long button actuation - Object 1 - Temperature value	K n - Output	2-byte	9,001	C, R, -, T, A
2-byte object to send temperature values if the button is briefly pressed (object 1).					

Object no.	Function	Name	Type	DPT	Flag
654, 670, ..., 766	Short and long button actuation - Object 2 - Temperature value	K n - Output	2-byte	9,001	C, R, -, T, A
2-byte object to send temperature values if the button is pressed and held (object 2).					

Object no.	Function	Name	Type	DPT	Flag
653, 669 ..., 765	Short and long button actuation - Object 1 - Brightness value	K n - Output	2-byte	9,004	C, R, -, T, A
2-byte object to transmit brightness values if the button is briefly pressed (object 1).					

Object no.	Function	Name	Type	DPT	Flag
654, 670, ..., 766	Short and long button actuation - Object 2 - Brightness value	K n - Output	2-byte	9,004	C, R, -, T, A
2-byte object to send brightness values if the button is pressed and held (object 2).					

Object no.	Function	Name	Type	DPT	Flag
653, 669 ..., 765	Short and long button actuation - Object 1 - Scene number 1...64	K n - Output	1-byte	18,001	C, R, -, T, A
1-byte object to send scene values if the button is briefly pressed (object 1).					

Object no.	Function	Name	Type	DPT	Flag
654, 670, ..., 766	Short and long button actuation - Object 2 - Scene number 1...64	K n - Output	1-byte	18,001	C, R, -, T, A
1-byte object to send scene values if the button is pressed and held (object 2).					

Object no.	Function	Name	Type	DPT	Flag
653, 669 ..., 765	Short and long button actuation - Object 1 - Colour temperature value and brightness value	K n - Output	6-byte	249,60 0	C, R, -, T, A
6-byte object used to transmit a colour temperature value, a brightness value and the adjustment time in the actuator (object 1). The actuator sets the received values during the adjustment time.					
<p>i These objects are visible only if "Short button actuation (object 1) = DPT 249.600 colour temperature value + brightness".</p>					

Object no.	Function	Name	Type	DPT	Flag
654, 670, ..., 766	Short and long button actuation - Object 2 - Colour temperature value and brightness value	K n - Output	6-byte	249,60 0	C, R, -, T, A
6-byte object used to transmit a colour temperature value, a brightness value and the adjustment time in the actuator (object 2). The actuator sets the received values during the adjustment time.					
<p>i These objects are visible only if "Long button actuation (object 2) = DPT 249.600 colour temperature value + brightness".</p>					

Object no.	Function	Name	Type	DPT	Flag
653, 669 ..., 765	Short and long button actuation - Object 1 - Operating mode	K n - Output	1-byte	20,102	C, R, -, T, A
1-byte object for switching a room temperature controller between the Comfort, Standby, Night and Frost/heat protection operating modes. This object is only visible if "Function = operating mode switchover".					
654, 670, ..., 766	Short and long button actuation - Object 2 - Operating mode	K n - Output	1-byte	20,102	C, R, -, T, A
1-byte object for switching a room temperature controller between the Comfort, Standby, Night and Frost/heat protection operating modes. This object is only visible if "Function = operating mode switchover".					
665, 681, ..., 777	Short and long button actuation - Object 1 - Operating mode - Status	K n - Input	1-byte	20,102	C, -, W, -, U
1-byte object for receiving the operating mode of a room temperature controller. This object is only visible if "Function = operating mode switchover".					
666, 682, ..., 778	Short and long button actuation - Object 2 - Operating mode - Status	K n - Input	1-byte	20,102	C, -, W, -, U
1-byte object for receiving the operating mode of a room temperature controller. This object is only visible if "Function = operating mode switchover".					
653, 669 ..., 765	Short and long button actuation - Object 1 - Operating mode - Forced	K n - Output	1-byte	20,102	C, R, -, T, A
1-byte object for switching a room temperature controller under forced control between the Automatic, Comfort, Standby, Night and Frost / heat protection operating modes. This object is only visible if "Function = forced operating mode switchover".					

Object no.	Function	Name	Type	DPT	Flag
654, 670, ..., 766	Short and long button actuation - Object 2 - Operating mode - Forced	K n - Output	1-byte	20,102	C, R, -, T, A

1-byte object for switching a room temperature controller under forced control between the Automatic, Comfort, Standby, Night and Frost / heat protection operating modes.

This object is only visible if "Function = forced operating mode switchover".

Object no.	Function	Name	Type	DPT	Flag
665, 681, ..., 777	Short and long button actuation - Object 1 - Operating mode - Forcing - Status	K n - Input	1-byte	20,102	C, -, W, -, U

1-byte object for receiving the operating mode of a room temperature controller.

This object is only visible if "Function = forced operating mode switchover".

Object no.	Function	Name	Type	DPT	Flag
666, 682, ..., 778	Short and long button actuation - Object 2 - Operating mode - Forcing - Status	K n - Input	1-byte	20,102	C, -, W, -, U

1-byte object for receiving the operating mode of a room temperature controller.

This object is only visible if "Function = forced operating mode switchover".

Object no.	Function	Name	Type	DPT	Flag
653, 669 ..., 765	Short and long button actuation - Object 1 - Presence	K n - Output	1-bit	1,018	C, R, -, T, A

1-bit object for changing over the presence status of a room temperature controller.

This object is only visible if "Function = presence function".

Object no.	Function	Name	Type	DPT	Flag
654, 670, ..., 766	Short and long button actuation - Object 2 - Presence	K n - Output	1-bit	1,018	C, R, -, T, A

1-bit object for changing over the presence status of a room temperature controller.

This object is only visible if "Function = presence function".

Object no.	Function	Name	Type	DPT	Flag
665, 681, ..., 777	Short and long button actuation - Object 1 - Presence - Status	K <i>n</i> - Input	1-bit	1,018	C, -, W, -, U
1-bit object for receiving the presence status of a room temperature controller. This object is only visible if "Function = presence function".					

Object no.	Function	Name	Type	DPT	Flag
666, 682, ..., 778	Short and long button actuation - Object 2 - Presence - Status	K <i>n</i> - Input	1-bit	1,018	C, -, W, -, U
1-bit object for receiving the presence status of a room temperature controller. This object is only visible if "Function = presence function".					

Object no.	Function	Name	Type	DPT	Flag
653, 669 ..., 765	Short and long button actuation - Object 1 - Setpoint temperature shift	K <i>n</i> - Output	2-byte	9,002	C, R, -, T, A
2-byte object for specification of a target temperature shift in Kelvin. The value "0" means that no shift is active . Values can be specified between -670760 K and 670760 K. This object is visible only if "function = target temperature shift" and "type of target temperature shift = above relative temperature value".					

Object no.	Function	Name	Type	DPT	Flag
654, 670, ..., 766	Short and long button actuation - Object 2 - Setpoint temperature shift	K <i>n</i> - Output	2-byte	9,002	C, R, -, T, A
2-byte object for specification of a target temperature shift in Kelvin. The value "0" means that no shift is active . Values can be specified between -670760 K and 670760 K. This object is visible only if "function = target temperature shift" and "type of target temperature shift = above relative temperature value".					

Object no.	Function	Name	Type	DPT	Flag
665, 681, ..., 777	Short and long button actuation - Object 1 - Setpoint temperature shift - Status	K <i>n</i> - Input	2-byte	9,002	C, -, W, -, U
<p>2-byte object for receiving the status of the current target temperature shift in Kelvin. This object is visible only if "function = target temperature shift" and "type of target temperature shift = above relative temperature value".</p>					

Object no.	Function	Name	Type	DPT	Flag
666, 682, ..., 778	Short and long button actuation - Object 2 - Setpoint temperature shift - Status	K <i>n</i> - Input	2-byte	9,002	C, -, W, -, U
<p>2-byte object for receiving the status of the current target temperature shift in Kelvin. This object is visible only if "function = target temperature shift" and "type of target temperature shift = above relative temperature value".</p>					

Object no.	Function	Name	Type	DPT	Flag
653, 669 ..., 765	Short and long button actuation - Object 1 - Setpoint temperature shift	K <i>n</i> - Output	1-byte	6,010	C, R, -, T, A
<p>1-byte object for specification of a target temperature shift. The value "0" means that no shift is active. The value is depicted in a two's complement in the positive or negative direction. This object is visible only if "function = target temperature shift" and "type of target temperature shift = above meter value".</p>					

Object no.	Function	Name	Type	DPT	Flag
654, 670, ..., 766	Short and long button actuation - Object 2 - Setpoint temperature shift	K <i>n</i> - Output	1-byte	6,010	C, R, -, T, A
<p>1-byte object for specification of a target temperature shift. The value "0" means that no shift is active. The value is depicted in a two's complement in the positive or negative direction. This object is visible only if "function = target temperature shift" and "type of target temperature shift = above meter value".</p>					

Object no.	Function	Name	Type	DPT	Flag
665, 681, ..., 777	Short and long button actuation - Object 1 - Setpoint temperature shift - Status	K <i>n</i> - Input	1-byte	6,010	C, -, W, -, U

1-byte object to receive the status of the current target temperature shift.

This object is visible only if "function = target temperature shift" and "type of target temperature shift = above meter value".

Object no.	Function	Name	Type	DPT	Flag
666, 682, ..., 778	Short and long button actuation - Object 2 - Setpoint temperature shift - Status	K <i>n</i> - Input	1-byte	6,010	C, -, W, -, U

1-byte object to receive the status of the current target temperature shift.

This object is visible only if "function = target temperature shift" and "type of target temperature shift = above meter value".

Object no.	Function	Name	Type	DPT	Flag
653, 669 ..., 765	Short and long button actuation - Object 1 - Colour value (RGB)	K <i>n</i> - Output	3-byte	232,60 0	C, R, -, T, A

3-byte object to send RBG values if the button is briefly pressed (object 1).

This object is visible only if "colour control = combi object: RGB or combi object: RGBW" was selected.

Object no.	Function	Name	Type	DPT	Flag
654, 670, ..., 766	Short and long button actuation - Object 2 - Colour value (RGB)	K <i>n</i> - Output	3-byte	232,60 0	C, R, -, T, A

3-byte object to send RBG values if the button is pressed and held (object 2).

This object is visible only if "colour control = combi object: RGB or combi object: RGBW" was selected.

Object no.	Function	Name	Type	DPT	Flag
653, 669 ..., 765	Short and long button actuation - Object 1 - Colour value (RGBW)	K <i>n</i> - Output	6-byte	251,60 0	C, R, -, T, A

6-byte object to send RBGW values if the button is briefly pressed (object 1).

This object is visible only if "colour control = combi object: RGB or combi object: RGBW" was selected.

Object no.	Function	Name	Type	DPT	Flag
654, 670, ..., 766	Short and long button actuation - Object 2 - Colour value (RGBW)	K n - Output	6-byte	251,600	C, R, -, T, A
6-byte object to send RBGW values if the button is pressed and held (object 2). This object is visible only if "colour control = combi object: RGB or combi object: RGBW" was selected.					

Object no.	Function	Name	Type	DPT	Flag
655, 671 ..., 767	Short and long button actuation - Object 1 - Red colour value	K n - Output	1-byte	5,001	C, R, -, T, A
1-byte object to send the red colour value if the button is briefly pressed (object 1). This object is visible only if "colour control = individual object: RGB or individual object: RGBW" was selected.					

Object no.	Function	Name	Type	DPT	Flag
659, 675 ..., 771	Short and long button actuation - Object 2 - Red colour value	K n - Output	1-byte	5,001	C, R, -, T, A
1-byte object to send the red colour value if the button is pressed and held (object 2). This object is visible only if "colour control = individual object: RGB or individual object: RGBW" was selected.					

Object no.	Function	Name	Type	DPT	Flag
656, 672 ..., 768	Short and long button actuation - Object 1 - Green colour value	K n - Output	1-byte	5,001	C, R, -, T, A
1-byte object to send the green colour value if the button is briefly pressed (object 1). This object is visible only if "colour control = individual object: RGB or individual object: RGBW" was selected.					

Object no.	Function	Name	Type	DPT	Flag
660, 676 ..., 772	Short and long button actuation - Object 2 - Green colour value	K n - Output	1-byte	5,001	C, R, -, T, A
1-byte object to send the green colour value if the button is pressed and held (object 2). This object is visible only if "colour control = individual object: RGB or individual object: RGBW" was selected.					

Object no.	Function	Name	Type	DPT	Flag
657, 673 ..., 769	Short and long button actuation - Object 1 - Blue colour value	K n - Output	1-byte	5,001	C, R, -, T, A
1-byte object to send the blue colour value if the button is briefly pressed (object 1). This object is visible only if "colour control = individual object: RGB or individual object: RGBW" was selected.					

Object no.	Function	Name	Type	DPT	Flag
661, 677 ..., 773	Short and long button actuation - Object 2 - Blue colour value	K n - Output	1-byte	5,001	C, R, -, T, A
1-byte object to send the blue colour value if the button is pressed and held (object 2). This object is visible only if "colour control = individual object: RGB or individual object: RGBW" was selected.					

Object no.	Function	Name	Type	DPT	Flag
655, 671 ..., 767	Short and long button actuation - Object 1 - Colour hue (H)	K n - Output	1-byte	5,003	C, R, -, T, A
1-byte object to send the colour hue if the button is briefly pressed (object 1). This object is visible only if "colour control = individual object: HSV or individual object: HSVW" was selected.					

Object no.	Function	Name	Type	DPT	Flag
659, 675 ..., 771	Short and long button actuation - Object 2 - Colour hue (H)	K n - Output	1-byte	5,003	C, R, -, T, A
1-byte object to send the colour hue if the button is pressed and held (object 2). This object is visible only if "colour control = individual object: HSV or individual object: HSVW" was selected.					

Object no.	Function	Name	Type	DPT	Flag
656, 672 ..., 768	Short and long button actuation - Object 1 - Saturation (S)	K n - Output	1-byte	5,001	C, R, -, T, A
1-byte object to send the saturation if the button is briefly pressed (object 1). This object is visible only if "colour control = individual object: HSV or individual object: HSVW" was selected.					

Object no.	Function	Name	Type	DPT	Flag
660, 676 ..., 772	Short and long button actuation - Object 2 - Saturation (S)	K n - Output	1-byte	5,001	C, R, -, T, A
1-byte object to send the saturation if the button is pressed and held (object 2). This object is visible only if "colour control = individual object: HSV or individual object: HSVW" was selected.					
Object no.	Function	Name	Type	DPT	Flag
657, 673 ..., 769	Short and long button actuation - Object 1 - Brightness value (V)	K n - Output	1-byte	5,001	C, R, -, T, A
1-byte object to send the brightness value if the button is briefly pressed (object 1). This object is visible only if "colour control = individual object: HSV or individual object: HSVW" was selected.					
Object no.	Function	Name	Type	DPT	Flag
661, 677 ..., 773	Short and long button actuation - Object 2 - Brightness value (V)	K n - Output	1-byte	5,001	C, R, -, T, A
1-byte object to send the brightness value if the button is pressed and held (object 2). This object is visible only if "colour control = individual object: HSV or individual object: HSVW" was selected.					
Object no.	Function	Name	Type	DPT	Flag
658, 674 ..., 770	Short and long button actuation - Object 1 - White value (W)	K n - Output	1-byte	5,001	C, R, -, T, A
1-byte object to send the white value if the button is briefly pressed (object 1). This object is visible only if "colour control = individual object: HSVW" was selected.					
Object no.	Function	Name	Type	DPT	Flag
662, 678 ..., 774	Short and long button actuation - Object 2 - White value (W)	K n - Output	1-byte	5,001	C, R, -, T, A
1-byte object to send the white value if the button is pressed and held (object 2). This object is visible only if "colour control = individual object: HSVW" was selected.					

Object no.	Function	Name	Type	DPT	Flag
664, 680, ..., 776	Short and long button actuation - Object 1/2 - Disabling	K <i>n</i> - Input	1-bit	1,003	C, -, W, -, U
1-bit object for activating or deactivating the disabling function. The object polarity can be parameterised.					

8.1.9 Room temperature control point

In the "push-button" channel function, the push-button can be parameterised for the "room temperature control point" function. The ETS indicates up to three communication objects for the "room temperature control point" function. The parameters can be used to determine the value the "RTC control point" objects obtain when the button is pressed. Furthermore, the behaviour of the channel after the bus voltage returns can be parameterised and a disabling function activated. No distinction is made between a brief or long press.

The "room temperature control point" channel function can be used to actuate a KNX room temperature controller.

The room temperature control point itself is not involved in the temperature control process. It allows the user to operate the single-room regulation from different points in the room. The room temperature control point can also be used to control central heating control devices located, for example, in a sub-distribution unit.

Typical KNX room temperature controllers generally offer different ways of influencing the room temperature control:

- Operating mode switchover:
Switching between different modes of operation (e. g. "Comfort", "Night" ...) with different setpoint temperatures assigned to each mode by the controller.
- Presence function:
Signalling the presence of a person in a room. The signalling may also be combined with a configured switchover in the mode of operation.
- Target temperature shift:
Adjustment of the target temperature via a temperature offset (DPT 9.002) or via levels (DPT 6.010).

The room temperature control point is operated with the button functions of the device. In this way, it is possible to completely control a room temperature controller by changing the operating mode, specifying the presence function or adjusting the target temperature shift.

8.1.9.1 Operating mode switchover

Switchover of the controller operating mode can be effected in accordance with the standard function block for room temperature controllers defined in the KNX handbook using two 1-byte communication objects. The operating mode can be switched over with the normal and with the forced objects. The object "RTC control point - Operating mode" allows different modes to be selected:

- Comfort
- Standby
- Night
- Frost/heat protection
- Switchover: comfort/standby
- Switchover: comfort/night

- Switchover: standby/night
- Switchover: comfort/standby/night

The communication object "RTC control point - Operating mode - Forcing" is of higher priority. It permits forced switching between the following modes of operation:

- Forcing inactive (auto)
- Comfort
- Standby
- Night
- Frost/heat protection
- Switchover: comfort/standby
- Switchover: comfort/night
- Switchover: standby/night
- Switchover: comfort/standby/night
- Toggle: forced inactive (auto) / comfort
- Toggle: forced inactive (auto) / standby
- Toggle: forced inactive (auto) / night
- Switchover: forced inactive (auto) / frost/heat protection

The operating mode transmitted to the bus when pressing the button of the room temperature control point is defined by the parameter "When pressed". Depending on the parameterised operating concept, either pressing a button will activate one of the above modes or each button actuation will toggle between two or three modes.

- i** It is recommended to visualise the state when switching over. The visualisation can take place by means of a switch setting or by a status LED, actuated, for example, via the output of the push-button interface.

8.1.9.2 Presence function

All channels whose functionality is set to "presence function" have the two communication objects "RTC control point - Presence" and "RTC control point - Presence - Status". The "When pressed" parameter determines the object value transmitted to the bus in the event of button actuation.

8.1.9.3 Target temperature shift

Another function of the room temperature control point that is available is the target temperature shift. It makes use of either two 2-byte communication objects with datapoint type 9.002 or two 1-byte communication objects with datapoint type 6.010 (integer with sign).

This control point function allows the basic setpoint for the temperature to be shifted on a room temperature controller by pressing a button. The control point is usually operated in the same way as the main control point. A button configured as target temperature shift reduces or increases the target temperature shift value each time

the button is pressed. The direction of the value adjustment is defined by the parameters "Increase target temperature difference when pressed" or "Reduce target temperature difference when pressed".

Communication with main controller

To enable the device to shift the target temperature on a room temperature controller, the controller must have input and output objects for the target temperature shift. In this case, the output object of the controller must be connected to the input object of the room temperature control point, and the input object of the controller must be connected to the output object of the room temperature control point in each case via their own group address.

All objects are of the same datapoint type and have the same value range. A target temperature shift is interpreted by count values: a shift in positive direction is expressed by positive values, whereas a shift in negative direction is represented by negative object values. An object value of "0" means that no target temperature shift has been set.

The room temperature control points detect the current position of the setpoint adjustment by means of the object "RTC control point - Target temperature shift - Status" of the room temperature control point connected to the room temperature controller. Starting from the value of the communication object, the setpoint is adjusted in the configured direction each time a button is pressed on a room temperature control point. Each time the setpoint is adjusted, the new shift by means of the object "RTC control point - Target temperature shift" of the room temperature control point is sent to the room temperature regulator.

With the "by counter value" function, the individual levels are weighted by the controller itself.

This requires that the respective communication objects are connected to all room temperature control points and the controller. The feedback information from the controller enables the room temperature control point to continue the adjustment at any time at the right point.

8.1.9.4 Table of parameters

The following parameters are available in the "push-button" channel function with the parameterised "room temperature control point" function.

Function	Operating mode switchover Forced oper. mode switchover Presence function Target temperature shift
A room temperature control point can optionally switch over (force) the operating mode with normal or high priority, change the presence status or change the current room temperature setpoint value. With regard to the setting of this parameter, the ETS shows further parameters.	
When pressed	Comfort Standby Night Frost/heat protection Switchover: comfort/standby Switchover: comfort/night Switchover: standby/night Switchover: comfort/standby/night
If the room temperature control point is intended to change over the operating mode of the room temperature controller with normal priority, the extension can either switch on a defined operating mode or switch between different operating modes when operated.	

When pressed	Forcing inactive (auto) Comfort Standby Night Frost/heat protection Switchover: comfort/standby Switchover: comfort/night Switchover: standby/night Switchover: comfort/standby/night Toggle: forced inactive (auto) / comfort Toggle: forced inactive (auto) / standby Toggle: forced inactive (auto) / night Switchover: forced inactive (auto) / frost/heat protection
--------------	--

If the room temperature control point is intended to switch the operating mode of the room temperature controller with high priority, the extension can either enable change-over with normal priority (auto), switch on a defined operating mode with high priority or switch different operating modes when operated.

When pressed	Presence ON Presence OFF Presence TOGGLE
--------------	---

The room temperature control point can switch the presence state of the room temperature controller either on or off in a defined way or the extension can switch between both states ("Presence TOGGLE") by pressing the button.
 This parameter is only visible if "Function = presence function".

Target temperature shift	By relative temperature value By meter value
--------------------------	--

Depending on the setting of the "Target temperature shift" parameter, the shift takes place by means of the 2-byte communication object in accordance with KNX DPT 9.002 or KNX DPT 6.010.
 This parameter is visible only if "function = target temperature shift".

When pressed	+2 K +1.5 K +1 K +0.5 K -0.5 K -1 K -1.5 K -2 K
--------------	---

The temperature difference is defined in Kelvin here by which the setpoint temperature will be shifted up or down when the button is pressed.

To shift the target temperature value, the room temperature control point uses the two communication objects "RTC control point - Target temperature shift" and "RTC control point - Target temperature shift - Status".

The communication object "RTC control point - Target temperature shift - Status" informs the room temperature control point about the current state of the room temperature controller. Based on this value and the parameter here, the room temperature control point calculates the new level value, which it sends to the room temperature controller via the communication object "RTC control point - Target temperature shift".

This parameter is visible only if "function = target temperature shift" and "type of target temperature shift = above relative temperature value".

When pressed	Increase setpoint temperature Reduce setpoint temperature
--------------	---

The direction of the target temperature shift is defined here at the room temperature control point.

To shift the target temperature value, the room temperature control point uses the two communication objects "RTC control point - Target temperature shift" and "RTC control point - Target temperature shift - Status".

The communication object "RTC control point - Target temperature shift - Status" informs the extension about the current state of the room temperature controller. Based on this value and the parameter here, the room temperature control point calculates the new level value, which it sends to the room temperature controller via the communication object "RTC control point - Target temperature shift".

This parameter is visible only if "function = target temperature shift" and "type of target temperature shift = above meter value".

After bus voltage return	no reaction Transmit current state Comfort Standby Night Frost/heat protection
--------------------------	--

This parameter determines the reaction after the bus voltage returns.
 Either no telegram, a telegram according to the current input state at the channel, a comfort telegram, a standby telegram, a night telegram or a frost/heat protection telegram is transmitted on the bus according to the parameterisation.
 The reaction after the bus voltage returns takes place only after the parameterised "delay after bus voltage returns" expires ("General" parameter page).
 Visible only if "Functionality = operating mode change-over".

After bus voltage return	no reaction Transmit current state Forcing inactive (auto) Comfort Standby Night Frost/heat protection
--------------------------	---

This parameter determines the reaction after the bus voltage returns.
 Either no telegram, a telegram according to the current input state at the channel, a forcing inactive (auto) telegram, a comfort telegram, a standby telegram, a night telegram or a frost/heat protection telegram is transmitted on the bus according to the parameterisation.
 The reaction after the bus voltage returns takes place only after the parameterised "delay after bus voltage returns" expires ("General" parameter page).
 Visible only if "Functionality = forced operating mode change-over".

After bus voltage return	no reaction Transmit current state Presence ON Presence OFF Presence TOGGLE
--------------------------	--

This parameter determines the reaction after the bus voltage returns.
 Either no telegram, a telegram according to the current input state at the channel or a presence telegram is transmitted on the bus according to the parameterisation.
 The reaction after the bus voltage returns takes place only after the parameterised "delay after bus voltage returns" expires ("General" parameter page).
 This parameter is only visible if "Function = presence function".

After bus voltage return	no reaction +2 K +1.5 K +1 K +0.5 K -0.5 K -1 K -1.5 K -2 K
--------------------------	--

This parameter determines the reaction after the bus voltage returns.
 Either no telegram or a temperature value telegram is transmitted on the bus according to the parameterisation.
 The reaction after the bus voltage returns takes place only after the parameterised "delay after bus voltage returns" expires ("General" parameter page).
 This parameter is visible only if "function = target temperature shift" and "type of target temperature shift = above relative temperature value".

After bus voltage return	no reaction Increase setpoint temperature Reduce setpoint temperature
--------------------------	--

This parameter determines the reaction after the bus voltage returns.
 Either no telegram or a counting value telegram is transmitted on the bus according to the parameterisation.
 The reaction after the bus voltage returns takes place only after the parameterised "delay after bus voltage returns" expires ("General" parameter page).
 This parameter is visible only if "function = target temperature shift" and "type of target temperature shift = above meter value".

Disabling function	Inactive Active
--------------------	---------------------------

This parameter enables the disabling function for the channel.

At the beginning of the disabling function	no reaction Comfort Standby Night Frost/heat protection
--	--

Besides disabling the channel, the device can immediately react when the disabling occurs.
 This parameter defines the reaction of the channel at the beginning of the disabling.
 Visible only if "Functionality = operating mode change-over".

At the beginning of the disabling function	no reaction Forcing inactive (auto) Comfort Standby Night Frost/heat protection
--	---

Besides disabling the channel, the device can immediately react when the disabling occurs.

This parameter defines the reaction of the channel at the beginning of the disabling. Visible only if "Functionality = forced operating mode change-over".

At the beginning of the disabling function	no reaction Presence ON Presence OFF Presence TOGGLE
--	--

Besides disabling the channel, the device can immediately react when the disabling occurs.

This parameter defines the reaction of the channel at the beginning of the disabling. This parameter is only visible if "Function = presence function".

At the beginning of the disabling function	no reaction +2 K +1.5 K +1 K +0.5 K -0.5 K -1 K -1.5 K -2 K
--	--

Besides disabling the channel, the device can immediately react when the disabling occurs.

This parameter defines the reaction of the channel at the beginning of the disabling. This parameter is visible only if "function = target temperature shift" and "type of target temperature shift = above relative temperature value".

At the beginning of the disabling function	no reaction Increase setpoint temperature Reduce setpoint temperature
Besides disabling the channel, the device can immediately react when the disabling occurs. This parameter defines the reaction of the channel at the beginning of the disabling. This parameter is visible only if "function = target temperature shift" and "type of target temperature shift = above meter value".	
At the end of the disabling function	no reaction Transmit current state Comfort Standby Night Frost/heat protection
Besides disabling the channel, the device can immediately react at the end of the disabling. This parameter defines the reaction of the channel at the end of the disabling. Visible only if "Functionality = operating mode change-over".	
At the end of the disabling function	no reaction Transmit current state Forcing inactive (auto) Comfort Standby Night Frost/heat protection
Besides disabling the channel, the device can immediately react at the end of the disabling. This parameter defines the reaction of the channel at the end of the disabling. Visible only if "Functionality = forced operating mode change-over".	
At the end of the disabling function	no reaction Transmit current state Presence ON Presence OFF Presence TOGGLE
Besides disabling the channel, the device can immediately react at the end of the disabling. This parameter defines the reaction of the channel at the end of the disabling. This parameter is only visible if "Function = presence function".	

At the end of the disabling function	no reaction +2 K +1.5 K +1 K +0.5 K -0.5 K -1 K -1.5 K -2 K
Besides disabling the channel, the device can immediately react at the end of the disabling. This parameter defines the reaction of the channel at the end of the disabling. This parameter is visible only if "function = target temperature shift" and "type of target temperature shift = above relative temperature value".	
At the end of the disabling function	no reaction Increase setpoint temperature Reduce setpoint temperature
Besides disabling the channel, the device can immediately react at the end of the disabling. This parameter defines the reaction of the channel at the end of the disabling. This parameter is visible only if "function = target temperature shift" and "type of target temperature shift = above meter value".	
Object polarity	0 = enabled / 1 = disable 1 = enabled / 0 = disable
This parameter defines the value of the disabling object at which the disabling function is active.	

8.1.9.5 Object list

The following communication objects are available in the "push-button" channel function with the parameterised "room temperature control point" function. The name can be adjusted with the "Name" parameter.

Object no.	Function	Name	Type	DPT	Flag
966, 980, ..., 1064	RTC control point - Operating mode	K n - Output	1-byte	20,102	C, R, -, T, A
1-byte object for switching a room temperature controller between the Comfort, Standby, Night and Frost/heat protection operating modes. This object is only visible if "Function = operating mode switchover".					

Object no.	Function	Name	Type	DPT	Flag
967, 981, ..., 1065	RTC control point - Operating mode - Status	K n - Input	1-byte	20,102	C, -, W, -, U
1-byte object for receiving the operating mode of a room temperature controller. This object is only visible if "Function = operating mode switchover".					

Object no.	Function	Name	Type	DPT	Flag
966, 980, ..., 1064	RTC control point - Operating mode - Forced	K n - Output	1-byte	20,102	C, R, -, T, A
1-byte object for switching a room temperature controller under forced control between the Automatic, Comfort, Standby, Night and Frost / heat protection operating modes. This object is only visible if "Function = forced operating mode switchover".					

Object no.	Function	Name	Type	DPT	Flag
967, 981, ..., 1065	RTC control point - Operating mode - Forced - Status	K n - Input	1-byte	20,102	C, -, W, -, U
1-byte object for receiving the operating mode of a room temperature controller. This object is only visible if "Function = forced operating mode switchover".					

Object no.	Function	Name	Type	DPT	Flag
966, 980, ..., 1064	RTC control point - Presence	K n - Output	1-bit	1,018	C, R, -, T, A
1-bit object for changing over the presence status of a room temperature controller. This object is only visible if "Function = presence function".					

Object no.	Function	Name	Type	DPT	Flag
967, 981, ..., 1065	RTC control point - Presence - Status	K <i>n</i> - Input	1-bit	1,018	C, -, W, -, U

1-bit object for receiving the presence status of a room temperature controller.
This object is only visible if "Function = presence function".

Object no.	Function	Name	Type	DPT	Flag
966, 980, ..., 1064	RTC control point - Target temperature shift	K <i>n</i> - Output	2-byte	9,002	C, R, -, T, A

2-byte object for specification of a target temperature shift in Kelvin. The value "0" means that no shift is active . Values can be specified between -670760 K and 670760 K.

This object is visible only if "function = target temperature shift" and "type of target temperature shift = above relative temperature value".

Object no.	Function	Name	Type	DPT	Flag
967, 981, ..., 1065	RTC control point - Target temperature shift - Status	K <i>n</i> - Input	2-byte	9,002	C, -, W, -, U

2-byte object for receiving the status of the current target temperature shift in Kelvin.
This object is visible only if "function = target temperature shift" and "type of target temperature shift = above relative temperature value".

Object no.	Function	Name	Type	DPT	Flag
966, 980, ..., 1064	RTC control point - Target temperature shift	K <i>n</i> - Output	1-byte	6,010	C, R, -, T, A

1-byte object for specification of a target temperature shift. The value "0" means that no shift is active . The value is depicted in a two's complement in the positive or negative direction.

This object is visible only if "function = target temperature shift" and "type of target temperature shift = above meter value".

Object no.	Function	Name	Type	DPT	Flag
967, 981, ..., 1065	RTC control point - Target temperature shift - Status	K <i>n</i> - Input	1-byte	6,010	C, -, W, -, U

1-byte object to receive the status of the current target temperature shift.

This object is visible only if "function = target temperature shift" and "type of target temperature shift = above meter value".

Object no.	Function	Name	Type	DPT	Flag
968, 982, ..., 1066	RTC control point - Disabling	K <i>n</i> - Input	1-bit	1,003	C, -, W, -, U
1-bit object for activating or deactivating the disabling function. The object polarity can be parameterised.					

8.2 Switch

The channel function can be parameterised for each channel. The following functions are available for each output object in the "switch" channel function:

- Switching
- Forced position
- Value transmitter
- Scene extension
- Room temperature control point

The ETS provides the corresponding parameters and communication objects dynamically for the function according to the parameterised function.

The debouncing time is to be parameterised separately for each channel. One or two output objects can be parameterised and actuated in the "switch" channel function. The available functions can be selected and combined independently of each other for both output objects. A disabling function can be activated optionally for each switch channel output object.

A command can be parameterised when closing and when opening the contact for each switch channel output object.

- i** The "switch" channel function is recommended if telegrams are to be transmitted cyclically on the KNX. This allows monitoring, similar to the heartbeat, to be implemented or rising and falling edges - like with the switch - to be evaluated regardless of the time.

8.2.1 Table of parameters

The following parameters are generally available for the "switch" channel function.

Number of objects	1 2
This parameter defines the number of output objects actuated in the "switch" channel function for each channel.	
Debounce time	4 ... 10 ... 255 ms
This parameter specifies the software debouncing time. A signal edge is evaluated at the input after a delay based on this time.	

The following parameters are available for each output object for the "switch" channel function.

Function	Switching Forced position Value transmitter Scene extension Room temperature control point
This parameter determines the function of the switch connected to the channel for each output object.	

8.2.2 Switching

In the "switch" channel function, each object of the switch can be parameterised separately for the "switching" function. The ETS indicates up to three communication objects for each switch channel output object for the "switching" function. The parameters can be used to determine which value the "switch" object receives when the contact is closed or opened. Furthermore, the behaviour of the switch channel output object after the bus voltage returns can be parameterised and a disabling function activated. The switching status of the switch channel output objects can be transmitted cyclically on the bus. No distinction is made between a brief or long press.

8.2.2.1 Table of parameters

The following parameters are available in the "switch" channel function with the parameterised "switching" function for each switch channel output object.

When closing the contact	no reaction ON OFF TOGGLE
This parameter determines the reaction when closing the contact of the switch. With "TOGGLE", the ETS application program makes the status object available.	
When opening the contact	no reaction ON OFF TOGGLE
This parameter determines the reaction when opening the contact of the switch. With "TOGGLE", the ETS application program makes the status object available.	
After bus voltage return	no reaction Transmit current state ON OFF
This parameter determines the reaction after the bus voltage returns. Either no telegram, a telegram according to the current input state at the channel, an ON telegram or an OFF telegram is transmitted on the bus according to the parameterisation. The reaction after the bus voltage returns takes place only after the parameterised "delay after bus voltage returns" expires ("General" parameter page).	

Send switching status cyclically	Inactive Active
<p>The switching status of the switch channel output objects can be transmitted cyclically on the bus.</p> <p>This parameter enables the cyclical transmission.</p>	
Cycle time	0...24 h 0...5...59 min 0...59 s
<p>This parameter defines the interval at which the switching status is transmitted on the bus.</p> <p>The cycle time can be parameterised between 3 seconds and 24 hours.</p>	
Disabling function	Inactive Active
<p>This parameter enables the disabling function for the channel.</p>	
At the beginning of the disabling function	no reaction ON OFF TOGGLE
<p>Besides disabling the channel, the device can immediately react when the disabling occurs.</p> <p>This parameter defines the reaction of the channel at the beginning of the disabling.</p> <p>i With "TOGGLE", the feedback of an actuator is to be connected with the "switching" object if the status object is not already made available by the settings of the parameter "When closing the contact" or "When opening the contact".</p>	
At the end of the disabling function	no reaction Transmit current state ON OFF TOGGLE
<p>Besides disabling the channel, the device can immediately react at the end of the disabling.</p> <p>This parameter defines the reaction of the channel at the end of the disabling.</p> <p>i With "TOGGLE", the feedback of an actuator is to be connected with the "switching" object if the status object is not already made available by the settings of the parameter "When closing the contact" or "When opening the contact".</p>	

Object polarity	0 = enabled / 1 = disable 1 = enabled / 0 = disable
This parameter defines the value of the disabling object at which the disabling function is active.	

8.2.2.2 Object list

The following communication objects are available in the "switch" channel function with the parameterised "switching" function. The name can be adjusted with the "Name" parameter.

Object no.	Function	Name	Type	DPT	Flag
253, 261, ..., 309	Object 1 - Switching	K <i>n</i> - Output	1-bit	1,001	C, R, -, T, A

1-bit object for transmission of switching telegrams (ON, OFF). This is object 1 of the parameterised output objects.

i With "TOGGLE", the feedback of an actuator is to be connected with the "switching" object if the status object is not already made available by the settings of the parameter "When closing the contact" or "When opening the contact".

Object no.	Function	Name	Type	DPT	Flag
254, 262, ..., 310	Object 1 - Switching -Status	K <i>n</i> - Input	1-bit	1,001	C, -, W, -, U

1-bit object for receiving feedback telegrams (ON, OFF). This is object 1 of the parameterised output objects.

This object is visible if the "When closing the contact" or "When opening the contact" parameter is parameterised to "TOGGLE".

Object no.	Function	Name	Type	DPT	Flag
255, 263, ..., 311	Object 1 - Switching - Disabling	K <i>n</i> - Input	1-bit	1,003	C, -, W, -, U

1-bit object for activating or deactivating the disabling function. The object polarity can be parameterised. This is object 1 of the parameterised output objects.

Object no.	Function	Name	Type	DPT	Flag
257, 265, ..., 313	Object 2 - Switching	K <i>n</i> - Output	1-bit	1,001	C, R, -, T, A

1-bit object for transmission of switching telegrams (ON, OFF). This is object 2 of the parameterised output objects.

i With "TOGGLE", the feedback of an actuator is to be connected with the "switching" object if the status object is not already made available by the settings of the parameter "When closing the contact" or "When opening the contact".

Object no.	Function	Name	Type	DPT	Flag
258, 266, ..., 314	Object 2 - Switching -Status	K <i>n</i> - Input	1-bit	1,001	C, -, W, -, U
<p>1-bit object for receiving feedback telegrams (ON, OFF). This is object 2 of the parameterised output objects.</p> <p>This object is visible if the "When closing the contact" or "When opening the contact" parameter is parameterised to "TOGGLE".</p>					
Object no.	Function	Name	Type	DPT	Flag
259, 267, ..., 315	Object 2 - Switching - Disabling	K <i>n</i> - Input	1-bit	1,003	C, -, W, -, U
<p>1-bit object for activating or deactivating the disabling function. The object polarity can be parameterised. This is object 2 of the parameterised output objects.</p>					

8.2.3 Forced position

In the "switch" channel function, each object of the switch can be parameterised separately for the "forced position" function. The ETS indicates up to two communication objects for each switch channel output object for the "forced position" function. The parameters can be used to determine which value the "forced position" object receives when the contact is closed or opened. Furthermore, the behaviour of the switch channel output object after the bus voltage returns can be parameterised and a disabling function activated. The switching status of the switch channel output objects can be transmitted cyclically on the bus. No distinction is made between a brief or long press.

- i** A forced position can be used as a superordinate, prioritised function. A forced position is recommended for load management or in service mode.

8.2.3.1 Table of parameters

The following parameters are available in the "switch" channel function with the parameterised "forced position" function for each switch channel output object.

When closing the contact	no reaction Forcing active, ON Forcing active, OFF Forcing inactive
This parameter determines the reaction when closing the contact of the switch.	
When opening the contact	no reaction Forcing active, ON Forcing active, OFF Forcing inactive
This parameter determines the reaction when opening the contact of the switch.	
After bus voltage return	no reaction Transmit current state Forcing active, ON Forcing active, OFF Forcing inactive
This parameter determines the reaction after the bus voltage returns. Either no telegram, a telegram according to the current input state at the channel, a forcing active ON telegram, a forcing active OFF telegram or a forcing inactive telegram is transmitted on the bus according to the parameterisation. The reaction after the bus voltage returns takes place only after the parameterised "delay after bus voltage returns" expires ("General" parameter page).	

Send switching status cyclically	Inactive Active
<p>The switching status of the switch channel output objects can be transmitted cyclically on the bus.</p> <p>This parameter enables the cyclical transmission.</p>	
Cycle time	0...24 h 0...5...59 min 0...59 s
<p>This parameter defines the interval at which the switching status is transmitted on the bus.</p> <p>The cycle time can be parameterised between 3 seconds and 24 hours.</p>	
Disabling function	Inactive Active
<p>This parameter enables the disabling function for the channel.</p>	
At the beginning of the disabling function	no reaction Forcing active, ON Forcing active, OFF Forcing inactive
<p>Besides disabling the channel, the device can immediately react when the disabling occurs.</p> <p>This parameter defines the reaction of the channel at the beginning of the disabling.</p>	
At the end of the disabling function	no reaction Transmit current state Forcing active, ON Forcing active, OFF Forcing inactive
<p>Besides disabling the channel, the device can immediately react at the end of the disabling.</p> <p>This parameter defines the reaction of the channel at the end of the disabling.</p>	
Object polarity	0 = enabled / 1 = disable 1 = enabled / 0 = disable
<p>This parameter defines the value of the disabling object at which the disabling function is active.</p>	

8.2.3.2 Object list

The following communication objects are available in the "switch" channel function with the parameterised "forced position" function. The name can be adjusted with the "Name" parameter.

Object no.	Function	Name	Type	DPT	Flag
253, 261, ..., 309	Object 1 - Forced position	K <i>n</i> - Output	2-bit	2,001	C, R, -, T, A

2-bit input object for activating and deactivating the forced position. With the value "1", bit 1 of the telegram activates the forced position. The assigned channels are then locked in the state specified by bit 0 ("0" = OFF / "1" = ON). The value "0" in bit 1 deactivates the forced position again. This is object 1 of the parameterised output objects.

0x = forcing inactive

10 = forcing active, OFF

11 = forcing active, ON

Object no.	Function	Name	Type	DPT	Flag
255, 263, ..., 311	Object 1 - Forced position - Disabling	K <i>n</i> - Input	1-bit	1,003	C, -, W, -, U

1-bit object for activating or deactivating the disabling function. The object polarity can be parameterised. This is object 1 of the parameterised output objects.

Object no.	Function	Name	Type	DPT	Flag
257, 265, ..., 313	Object 2 - Forced position	K <i>n</i> - Output	2-bit	2,001	C, R, -, T, A

2-bit input object for activating and deactivating the forced position. With the value "1", bit 1 of the telegram activates the forced position. The assigned channels are then locked in the state specified by bit 0 ("0" = OFF / "1" = ON). The value "0" in bit 1 deactivates the forced position again. This is object 2 of the parameterised output objects.

0x = forcing inactive

10 = forcing active, OFF

11 = forcing active, ON

Object no.	Function	Name	Type	DPT	Flag
259, 267, ..., 315	Object 2 - Forced position - Disabling	K <i>n</i> - Input	1-bit	1,003	C, -, W, -, U

1-bit object for activating or deactivating the disabling function. The object polarity can be parameterised. This is object 2 of the parameterised output objects.

8.2.4 Value transmitter

In the "switch" channel function, each object of the switch can be parameterised separately for the "value transmitter" function. The ETS indicates up to six communication objects for each switch channel output object for the "value transmitter" function. The parameters can be used to determine which value the "value transmitter" objects receive when the contact is closed or opened.

Furthermore, the behaviour of the switch channel output object after the bus voltage returns can be parameterised and a disabling function activated. The value status of the switch channel output objects can be transmitted cyclically on the bus. No distinction is made between a brief or long press.

The "value transmitter" function is used by the device to transmit parameterised values on the bus when closing and opening the contact.

Value ranges

The value transmitter knows 13 different value ranges. The parameter "Data point type | Value range" determines the value range used by the value transmitter, depending on the application case:

Function	Function	Lower numerical limit	Upper numerical limit
1-byte value transmitter	0...100%	0%	100%
1-byte value transmitter	0...255	0	255
1-byte value transmitter	0...360°	0°	360°
1-byte value transmitter	0...255%	0%	255%
1-byte value transmitter	-128...127	-128	127
2-byte value transmitter	0...65535	0	65535
2-byte value transmitter	Colour temperature value	1000 K	10000 K
2-byte value transmitter	-32768...32767	-32768	32767
2-byte value transmitter	Temperature value	0°C	40°C
2-byte value transmitter	Brightness value	0 lux	1500 lux
6-byte value transmitter	Colour temperature value + brightness	1000 K 0%	10000 K 100%
3-byte value transmitter	RGB/HSV	#000000	#FFFFFF

Function	Function	Lower numerical limit	Upper numerical limit
6-byte value transmitter	Colour value RGBW/HSVW	#000000 + 0	#FFFFFF + 255

The value that can be transmitted on the bus when closing and/or opening the contact can be parameterised for each of these ranges.

8.2.4.1 Table of parameters

The following parameters are available in the "switch" channel function with the parameterised "value transmitter" function for each switch channel output object.

Data point type Value range	DPT 5.001 0 ... 100% DPT 5.010 0 ... 255 DPT 5.003 0 ... 360° DPT 5.004 0 ... 255% DPT 6.010 -128 ... 127 DPT 7.001 0 ... 65535 DPT 7.600 1000 ... 10000 K DPT 8.001 -32768 ... 32767 DPT 9.001 0 ... 40°C DPT 9.004 0 ... 1500 lux DPT 249.600 Colour temperature value + brightness RGB/HSV (RGB: DPT 232.600, HSV: DPT 5.003, DPT 5.001, DPT 5.001) Colour value RGBW/HSVW (RGBW: DPT 251.600, HSVW: DPT 5.003, DPT 5.001, DPT 5.001, DPT 5.001)
-------------------------------	--

The "value transmitter" function distinguishes between 1-byte, 2-byte 3-byte and 6-byte values.
 The following parameters and their settings depend on the setting for this parameter.

When closing the contact	no reaction Transmit value
--------------------------	--------------------------------------

This parameter determines the reaction when closing the contact of the switch.
 Transmit value: The ETS displays a suitable input field where the value can be entered according to the set "data point type | value range".

When opening the contact	no reaction Transmit value
--------------------------	-------------------------------

This parameter determines the reaction when opening the contact of the switch.
 Transmit value: The ETS displays a suitable input field where the value can be entered according to the set "data point type | value range".

Value	0 ... 100%
-------	-------------------

This parameter determines the object value when closing or opening the contact.
 It is visible only if "data point type | value range = DPT 5.001 | 0 ... 100%".

Value	0 ... 255
This parameter determines the object value when closing or opening the contact. It is visible only if "data point type value range = DPT 5.010 0 ... 255".	
Value	0 ... 360°
This parameter determines the object value when closing or opening the contact. It is visible only if "data point type value range = DPT 5.003 0 ... 360°".	
Value	0 ... 255%
This parameter determines the object value when closing or opening the contact. It is visible only if "data point type value range = DPT 5.004 0 ... 255%".	
Value	-128...0 ... 127
This parameter determines the object value when closing or opening the contact. It is visible only if "data point type value range = DPT 6.010 -128 ... 127".	
Value	0 ... 65535
This parameter determines the object value when closing or opening the contact. It is visible only if "data point type value range = DPT 7.001 0 ... 65535".	
Colour temperature value	1000 ... 2700 ... 10000 K
This parameter determines the object value when closing or opening the contact. It is visible only if "data point type value range = DPT 7.600 1000 ... 10000 K".	
Value	-32768 ... 0 ... 32767
This parameter determines the object value when closing or opening the contact. It is visible only if "data point type value range = DPT 8.001 -32768 ... 32767".	
Temperature value	0 ... 20 ... 40°C
This parameter determines the object value when closing or opening the contact. It is visible only if "data point type value range = DPT 9.001 0 ... 40°C".	
Brightness value	0, 50 ... 300 ... 1500 lux
This parameter determines the object value when closing or opening the contact. It is visible only if "data point type value range = DPT 9.004 0 ... 1500 lux".	
Colour temperature value	1000 ... 2700 ... 10000 K
This parameter determines the object value when closing or opening the contact. It is visible only if "data point type value range = DPT 249.600 colour temperature value + brightness".	
Brightness value	0 ... 100%
This parameter determines the object value when closing or opening the contact. It is visible only if "data point type value range = DPT 249.600 colour temperature value + brightness".	

Adjustment duration in the actuator	0 ... 100 min, 0, 1 ... 59 s, 0 ... 900 ms
<p>This parameter determines the object value when closing or opening the contact. It is visible only if "data point type value range = DPT 249.600 colour temperature value + brightness".</p>	
Colour value	#000000 ... #FFFFFF
<p>This parameter determines the object values of the 3-byte value transmitter (or 6-byte value transmitter), brightness value (V), saturation (S) and colour hue (H) objects when closing or opening the contact.</p> <p>It is visible with "data point type value range = RGB/HSV with colour wheel sequence (RGB: DPT 232.600, HSV: DPT 5.003, DPT 5.001, DPT 5.001)", "data point type value range = RGB/HSV with brightness adjustment (RGB: DPT 232.600, HSV: DPT 5.003, DPT 5.001, DPT 5.001)" and "data point type value range = colour value RGBW/HSVW (RGBW: DPT 251.600, HSVW: DPT 5.003, DPT 5.001, DPT 5.001, DPT 5.001)".</p> <p>The value (RGB/HSV) is configured by means of a colour picker.</p> <p>With the data point type value range "colour value RGBW/HSVW (RGBW: DPT 251.600, HSVW: DPT 5.003, DPT 5.001, DPT 5.001, DPT 5.001)", the white value is configured by means of a separate slider.</p>	
White value when pressed	0 ... 255
<p>This parameter determines the object value of the white value (W) object when closing or opening the contact.</p> <p>It is visible only if "data point type value range = colour value RGBW/HSVW (RGBW: DPT 251.600, HSVW: DPT 5.003, DPT 5.001, DPT 5.001, DPT 5.001)".</p>	
After bus voltage return	<p>no reaction</p> <p>Transmit current state</p> <p>Transmit value</p>
<p>This parameter determines the reaction after the bus voltage returns.</p> <p>Either no telegram, a telegram according to the current input state at the channel or a value parameterised accordingly for the set data point type value range is transmitted on the bus.</p> <p>The reaction after the bus voltage returns takes place only after the parameterised "delay after bus voltage returns" expires ("General" parameter page).</p>	
Value	0 ... 100%
<p>This parameter determines the object value after the bus voltage returns. It is visible only if "data point type value range = DPT 5.001 0 ... 100%".</p>	
Value	0 ... 255
<p>This parameter determines the object value after the bus voltage returns. It is visible only if "data point type value range = DPT 5.010 0 ... 255".</p>	

Value	0 ... 360°
This parameter determines the object value after the bus voltage returns. It is visible only if "data point type value range = DPT 5.003 0 ... 360°".	
Value	0 ... 255%
This parameter determines the object value after the bus voltage returns. It is visible only if "data point type value range = DPT 5.004 0 ... 255%".	
Value	-128...0 ... 127
This parameter determines the object value after the bus voltage returns. It is visible only if "data point type value range = DPT 6.010 -128 ... 127".	
Value	0 ... 65535
This parameter determines the object value after the bus voltage returns. It is visible only if "data point type value range = DPT 7.001 0 ... 65535".	
Colour temperature value	1000 ... 2700 ... 10000 K
This parameter determines the object value after the bus voltage returns. It is visible only if "data point type value range = DPT 7.600 1000 ... 10000 K".	
Value	-32768 ... 0 ... 32767
This parameter determines the object value after the bus voltage returns. It is visible only if "data point type value range = DPT 8.001 -32768 ... 32767".	
Temperature value	0 ... 20 ... 40°C
This parameter determines the object value after the bus voltage returns. It is visible only if "data point type value range = DPT 9.001 0 ... 40°C".	
Brightness value	0, 50 ... 300 ... 1500 lux
This parameter determines the object value after the bus voltage returns. It is visible only if "data point type value range = DPT 9.004 0 ... 1500 lux".	
Colour temperature value	1000 ... 2700 ... 10000 K
This parameter determines the object value after the bus voltage returns. It is visible only if "data point type value range = DPT 249.600 colour temperature value + brightness".	
Brightness value	0 ... 100%
This parameter determines the object value after the bus voltage returns. It is visible only if "data point type value range = DPT 249.600 colour temperature value + brightness".	

Adjustment duration in the actuator	0 ... 100 min, 0, 1 ... 59 s, 0 ... 900 ms
<p>This parameter determines the object value after the bus voltage returns.</p> <p>It is visible only if "data point type value range = DPT 249.600 colour temperature value + brightness".</p>	
Colour value	#000000 ... #FFFFFF
<p>This parameter determines the object values of the 3-byte value transmitter (or 6-byte value transmitter), brightness value (V), saturation (S) and colour hue (H) objects after the bus voltage returns.</p> <p>It is visible with "data point type value range = RGB/HSV with colour wheel sequence (RGB: DPT 232.600, HSV: DPT 5.003, DPT 5.001, DPT 5.001)", "data point type value range = RGB/HSV with brightness adjustment (RGB: DPT 232.600, HSV: DPT 5.003, DPT 5.001, DPT 5.001)" and "data point type value range = colour value RGBW/HSVW (RGBW: DPT 251.600, HSVW: DPT 5.003, DPT 5.001, DPT 5.001, DPT 5.001)".</p> <p>The value (RGB/HSV) is configured by means of a colour picker.</p> <p>With the data point type value range "colour value RGBW/HSVW (RGBW: DPT 251.600, HSVW: DPT 5.003, DPT 5.001, DPT 5.001, DPT 5.001)", the white value is configured by means of a separate slider.</p>	
White value	0 ... 255
<p>This parameter determines the object value of the white value (W) after the bus voltage returns.</p> <p>It is visible only if "data point type value range = colour value RGBW/HSVW (RGBW: DPT 251.600, HSVW: DPT 5.003, DPT 5.001, DPT 5.001, DPT 5.001)".</p>	
Transmit value cyclically	Inactive Active
<p>The value status of the switch channel output objects can be transmitted cyclically on the bus.</p> <p>This parameter enables the cyclical transmission.</p>	
Cycle time	0...24 h 0...5...59 min 0...59 s
<p>This parameter defines the interval at which the value status is transmitted on the bus.</p> <p>The cycle time can be parameterised between 3 seconds and 24 hours.</p>	
Disabling function	Inactive Active
<p>This parameter enables the disabling function for the channel.</p>	

At the beginning of the disabling function	no reaction Transmit value
Besides disabling the channel, the device can immediately react when the disabling occurs. This parameter defines the reaction of the channel at the beginning of the disabling.	
Value	0 ... 100%
This parameter determines the object value at the beginning of the disabling. It is visible only if "data point type value range = DPT 5.001 0 ... 100%".	
Value	0 ... 255
This parameter determines the object value at the beginning of the disabling. It is visible only if "data point type value range = DPT 5.010 0 ... 255".	
Value	0 ... 360°
This parameter determines the object value at the beginning of the disabling. It is visible only if "data point type value range = DPT 5.003 0 ... 360°".	
Value	0 ... 255%
This parameter determines the object value at the beginning of the disabling. It is visible only if "data point type value range = DPT 5.004 0 ... 255%".	
Value	-128...0 ... 127
This parameter determines the object value at the beginning of the disabling. It is visible only if "data point type value range = DPT 6.010 -128 ... 127".	
Value	0 ... 65535
This parameter determines the object value at the beginning of the disabling. It is visible only if "data point type value range = DPT 7.001 0 ... 65535".	
Colour temperature value	1000 ... 2700 ... 10000 K
This parameter determines the object value at the beginning of the disabling. It is visible only if "data point type value range = DPT 7.600 1000 ... 10000 K".	
Value	-32768 ... 0 ... 32767
This parameter determines the object value at the beginning of the disabling. It is visible only if "data point type value range = DPT 8.001 -32768 ... 32767".	
Temperature value	0 ... 20 ... 40°C
This parameter determines the object value at the beginning of the disabling. It is visible only if "data point type value range = DPT 9.001 0 ... 40°C".	

Brightness value	0, 50 ... 300 ... 1500 lux
This parameter determines the object value at the beginning of the disabling. It is visible only if "data point type value range = DPT 9.004 0 ... 1500 lux".	
Colour temperature value	1000 ... 2700 ... 10000 K
This parameter determines the object value at the beginning of the disabling. It is visible only if "data point type value range = DPT 249.600 colour temperature value + brightness".	
Brightness value	0 ... 100%
This parameter determines the object value at the beginning of the disabling. It is visible only if "data point type value range = DPT 249.600 colour temperature value + brightness".	
Adjustment duration in the actuator	0 ... 100 min, 0, 1 ... 59 s, 0 ... 900 ms
This parameter determines the object value at the beginning of the disabling. It is visible only if "data point type value range = DPT 249.600 colour temperature value + brightness".	
Colour value	#000000 ... #FFFFFF
This parameter determines the object values of the 3-byte value transmitter (or 6-byte value transmitter), brightness value (V), saturation (S) and colour hue (H) objects at the beginning of the disabling. It is visible with "data point type value range = RGB/HSV with colour wheel sequence (RGB: DPT 232.600, HSV: DPT 5.003, DPT 5.001, DPT 5.001)", "data point type value range = RGB/HSV with brightness adjustment (RGB: DPT 232.600, HSV: DPT 5.003, DPT 5.001, DPT 5.001)" and "data point type value range = colour value RGBW/HSVW (RGBW: DPT 251.600, HSVW: DPT 5.003, DPT 5.001, DPT 5.001, DPT 5.001)". The value (RGB/HSV) is configured by means of a colour picker. With the data point type value range "colour value RGBW/HSVW (RGBW: DPT 251.600, HSVW: DPT 5.003, DPT 5.001, DPT 5.001, DPT 5.001)", the white value is configured by means of a separate slider.	
White value	0 ... 255
This parameter determines the object value of the white value (W) object at the beginning of the disabling. It is visible only if "data point type value range = colour value RGBW/HSVW (RGBW: DPT 251.600, HSVW: DPT 5.003, DPT 5.001, DPT 5.001, DPT 5.001)".	

At the end of the disabling function	no reaction Transmit current state Transmit value
Besides disabling the channel, the device can immediately react at the end of the disabling. This parameter defines the reaction of the channel at the end of the disabling.	
Value	0 ... 100%
This parameter determines the object value at the end of the disabling. It is visible only if "data point type value range = DPT 5.001 0 ... 100%".	
Value	0 ... 255
This parameter determines the object value at the end of the disabling. It is visible only if "data point type value range = DPT 5.010 0 ... 255".	
Value	0 ... 360°
This parameter determines the object value at the end of the disabling. It is visible only if "data point type value range = DPT 5.003 0 ... 360°".	
Value	0 ... 255%
This parameter determines the object value at the end of the disabling. It is visible only if "data point type value range = DPT 5.004 0 ... 255%".	
Value	-128...0 ... 127
This parameter determines the object value at the end of the disabling. It is visible only if "data point type value range = DPT 6.010 -128 ... 127".	
Value	0 ... 65535
This parameter determines the object value at the end of the disabling. It is visible only if "data point type value range = DPT 7.001 0 ... 65535".	
Colour temperature value	1000 ... 2700 ... 10000 K
This parameter determines the object value at the end of the disabling. It is visible only if "data point type value range = DPT 7.600 1000 ... 10000 K".	
Value	-32768 ... 0 ... 32767
This parameter determines the object value at the end of the disabling. It is visible only if "data point type value range = DPT 8.001 -32768 ... 32767".	
Temperature value	0 ... 20 ... 40°C
This parameter determines the object value at the end of the disabling. It is visible only if "data point type value range = DPT 9.001 0 ... 40°C".	

Brightness value	0, 50 ... 300 ... 1500 lux
This parameter determines the object value at the end of the disabling. It is visible only if "data point type value range = DPT 9.004 0 ... 1500 lux".	
Colour temperature value	1000 ... 2700 ... 10000 K
This parameter determines the object value at the end of the disabling. It is visible only if "data point type value range = DPT 249.600 colour temperature value + brightness".	
Brightness value	0 ... 100%
This parameter determines the object value at the end of the disabling. It is visible only if "data point type value range = DPT 249.600 colour temperature value + brightness".	
Adjustment duration in the actuator	0 ... 100 min, 0, 1 ... 59 s, 0 ... 900 ms
This parameter determines the object value at the end of the disabling. It is visible only if "data point type value range = DPT 249.600 colour temperature value + brightness".	
Colour value	#000000 ... #FFFFFF
This parameter determines the object values of the 3-byte value transmitter (or 6-byte value transmitter), brightness value (V), saturation (S) and colour hue (H) objects at the end of the disabling. It is visible with "data point type value range = RGB/HSV with colour wheel sequence (RGB: DPT 232.600, HSV: DPT 5.003, DPT 5.001, DPT 5.001)", "data point type value range = RGB/HSV with brightness adjustment (RGB: DPT 232.600, HSV: DPT 5.003, DPT 5.001, DPT 5.001)" and "data point type value range = colour value RGBW/HSVW (RGBW: DPT 251.600, HSVW: DPT 5.003, DPT 5.001, DPT 5.001, DPT 5.001)". The value (RGB/HSV) is configured by means of a colour picker. With the data point type value range "colour value RGBW/HSVW (RGBW: DPT 251.600, HSVW: DPT 5.003, DPT 5.001, DPT 5.001, DPT 5.001)", the white value is configured by means of a separate slider.	
White value	0 ... 255
This parameter determines the object value of the white value (W) object at the end of the disabling. It is visible only if "data point type value range = colour value RGBW/HSVW (RGBW: DPT 251.600, HSVW: DPT 5.003, DPT 5.001, DPT 5.001, DPT 5.001)".	
Object polarity	0 = enabled / 1 = disable 1 = enabled / 0 = disable
This parameter defines the value of the disabling object at which the disabling function is active.	

8.2.4.2 Object list

The following communication objects are available in the "switch" channel function with the parameterised "value transmitter" function. The name can be adjusted with the "Name" parameter.

Object no.	Function	Name	Type	DPT	Flag
397, 421, ..., 565	Object 1 - Value transmitter - 0...100%	K n - Output	1-byte	5,001	C, R, -, T, A
409, 433, ..., 577	Object 2 - Value transmitter - 0...100%				

1-byte object for the transmission of values from 0 to 100%. This is object 1 or 2 of the parameterised output objects.

i These objects are visible only if "data point type | value range = DPT 5.001 | 0 ... 100%".

Object no.	Function	Name	Type	DPT	Flag
397, 421, ..., 565	Object 1 - Value transmitter - 0...255	K n - Output	1-byte	5,010	C, R, -, T, A
409, 433, ..., 577	Object 2 - Value transmitter - 0...255				

1-byte object for the transmission of values from 0 to 255. This is object 1 or 2 of the parameterised output objects.

i These objects are visible only if "data point type | value range = DPT 5.010 | 0 ... 255".

Object no.	Function	Name	Type	DPT	Flag
397, 421, ..., 565	Object 1 - Value transmitter - 0...360	K n - Output	1-byte	5,003	C, R, -, T, A
409, 433, ..., 577	Object 2 - Value transmitter - 0...360				

1-byte object for the transmission of values from 0 to 360°. This is object 1 or 2 of the parameterised output objects.

i These objects are visible only if "data point type | value range = DPT 5.003 | 0 ... 360°".

Object no.	Function	Name	Type	DPT	Flag
397, 421, ..., 565	Object 1 - Value transmitter - 0...255%	K n - Output	1-byte	5,004	C, R, -, T, A
409, 433, ..., 577	Object 2 - Value transmitter - 0...255%				

1-byte object for the transmission of values from 0 to 255%. This is object 1 or 2 of the parameterised output objects.

i These objects are visible only if "data point type | value range = DPT 5.004 | 0 ... 255%".

Object no.	Function	Name	Type	DPT	Flag
397, 421, ..., 565	Object 1 - Value transmitter - -128...127	K n - Output	1-byte	6,010	C, R, -, T, A
409, 433, ..., 577	Object 2 - Value transmitter - -128...127				

1-byte object for the transmission of values from -128 to 127. This is object 1 or 2 of the parameterised output objects.

i These objects are visible only if "data point type | value range = DPT 6.010 | -128 ... 127".

Object no.	Function	Name	Type	DPT	Flag
397, 421, ..., 565	Object 1 - Value transmitter - 0...65535	K n - Output	2-byte	7,001	C, R, -, T, A
409, 433, ..., 577	Object 2 - Value transmitter - 0...65535				

2-byte object for the transmission of values from 0 to 65535. This is object 1 or 2 of the parameterised output objects.

i These objects are visible only if "data point type | value range = DPT 7.001 | 0 ... 65535".

Object no.	Function	Name	Type	DPT	Flag
397, 421, ..., 565	Object 1 - Value transmitter - Colour temperature value	K n - Output	2-byte	7,600	C, R, -, T, A
409, 433, ..., 577	Object 2 - Value transmitter - Colour temperature value				

2-byte object for transmitting colour temperatures from 1000 to 10000 Kelvin. This is object 1 or 2 of the parameterised output objects.

i These objects are visible only if "data point type | value range = DPT 7.600 | 1000 ... 10000 K".

Object no.	Function	Name	Type	DPT	Flag
397, 421, ..., 565	Object 1 - Value transmitter - -32768...32767	K n - Output	2-byte	8,001	C, R, -, T, A
409, 433, ..., 577	Object 2 - Value transmitter - -32768...32767				

2-byte object for the transmission of values from -32768 to 32767. This is object 1 or 2 of the parameterised output objects.

i These objects are visible only if "data point type | value range = DPT 8.001 | -32768 ... 32767".

Object no.	Function	Name	Type	DPT	Flag
397, 421, ..., 565	Object 1 - Value transmitter - Temperature value	K n - Output	2-byte	9,001	C, R, -, T, A
409, 433, ..., 577	Object 2 - Value transmitter - Temperature value				

2-byte object for transmitting temperature values from 0 to 40 °C. This is object 1 or 2 of the parameterised output objects.

i These objects are visible only if "data point type | value range = DPT 9.001 | 0 ... 40°C".

Object no.	Function	Name	Type	DPT	Flag
397, 421, ..., 565	Object 1 - Value transmitter - Brightness value	K n - Output	2-byte	9,004	C, R, -, T, A
409, 433, ..., 577	Object 2 - Value transmitter - Brightness value				

2-byte object for the transmission of brightness values from 0 to 1500 lux. This is object 1 or 2 of the parameterised output objects.

i These objects are visible only if "data point type | value range = DPT 9.004 | 0 ... 1500 lux".

Object no.	Function	Name	Type	DPT	Flag
397, 421, ..., 565	Object 1 - Value transmitter - Colour temperature value and brightness value	K n - Output	6-byte	249,600	C, R, -, T, A
409, 433, ..., 577	Object 2 - Value transmitter - Colour temperature value and brightness value				

6-byte object used to transmit a colour temperature value, a brightness value and the adjustment time in the actuator. The actuator sets the received values during the adjustment time. This is object 1 or 2 of the parameterised output objects.

i These objects are visible only if "data point type | value range = DPT 249.600 | colour temperature value + brightness" applies.

Object no.	Function	Name	Type	DPT	Flag
397, 421, ..., 565	Object 1 - Value transmitter - RGB/HSV (colour wheel sequence)	K n - Output	3-byte	232,600	C, R, -, T, A
409, 433, ..., 577	Object 2 - Value transmitter - RGB/HSV (colour wheel sequence)				

3-byte object for transmitting 3-byte colour information. This is object 1 or 2 of the parameterised output objects.

i These objects are visible only if "data point type | value range = RGB/HSV with colour wheel sequence (RGB: DPT 232.600, HSV: DPT 5.003, DPT 5.001, DPT 5.001)".

Object no.	Function	Name	Type	DPT	Flag
397, 421, ..., 565	Object 1 - Value transmitter - RGB/HSV (brightness adjustment)	K n - Output	3-byte	232,600	C, R, -, T, A
409, 433, ..., 577	Object 2 - Value transmitter - RGB/HSV (brightness adjustment)				
<p>3-byte object for transmitting 3-byte colour information. This is object 1 or 2 of the parameterised output objects.</p> <p>i These objects are visible only with data point type value range: RGB/HSV with brightness adjustment (RGB: DPT 232.600, HSV: DPT 5.003, DPT 5.001, DPT 5.001).</p>					

Object no.	Function	Name	Type	DPT	Flag
397, 421, ..., 565	Object 1 - Value transmitter - RGBW	K n - Output	6-byte	251,600	C, R, -, T, A
409, 433, ..., 577	Object 2 - Value transmitter - RGBW				
<p>6-byte object for transmitting 6-byte colour information. This is object 1 or 2 of the parameterised output objects.</p> <p>i These objects are visible only with data point type value range: colour value RGBW/HSVW (RGBW: DPT 251.600, HSVW: DPT 5.003, DPT 5.001, DPT 5.001, DPT 5.001).</p>					

Object no.	Function	Name	Type	DPT	Flag
398, 422, ..., 566	Object 1 - Value transmitter - Colour hue (H)	K n - Output	1-byte	5,003	C, R, -, T, A
410, 434, ..., 578	Object 2 - Value transmitter - Colour hue (H)				
<p>1-byte object for transmitting the colour hue. This is object 1 or 2 of the parameterised output objects.</p> <p>i These objects are visible only with data point type value range:</p> <ul style="list-style-type: none"> - RGB/HSV with colour wheel sequence (RGB: DPT 232.600, HSV: DPT 5.003, DPT 5.001, DPT 5.001) - RGB/HSV with brightness adjustment (RGB: DPT 232.600, HSV: DPT 5.003, DPT 5.001, DPT 5.001) - Colour value RGBW/HSVW (RGBW: DPT 251.600, HSVW: DPT 5.003, DPT 5.001, DPT 5.001, DPT 5.001) 					

Object no.	Function	Name	Type	DPT	Flag
399, 423, ..., 567	Object 1 - Value transmitter - Saturation (S)	K n - Output	1-byte	5,001	C, R, -, T, A
411, 435, ..., 579	Object 2 - Value transmitter - Saturation (S)				

1-byte object for transmitting the saturation. This is object 1 or 2 of the parameterised output objects.

- i** These objects are visible only with data point type | value range:
- RGB/HSV with colour wheel sequence (RGB: DPT 232.600, HSV: DPT 5.003, DPT 5.001, DPT 5.001)
 - RGB/HSV with brightness adjustment (RGB: DPT 232.600, HSV: DPT 5.003, DPT 5.001, DPT 5.001)
 - Colour value RGBW/HSVW (RGBW: DPT 251.600, HSVW: DPT 5.003, DPT 5.001, DPT 5.001, DPT 5.001)

Object no.	Function	Name	Type	DPT	Flag
400, 424, ..., 568	Object 1 - Value transmitter - brightness value (V)	K n - Output	1-byte	5,001	C, R, -, T, A
412, 436, ..., 580	Object 2 - Value transmitter - brightness value (V)				

1-byte object for transmitting the brightness value. This is object 1 or 2 of the parameterised output objects.

- i** These objects are visible only with data point type | value range:
- RGB/HSV with colour wheel sequence (RGB: DPT 232.600, HSV: DPT 5.003, DPT 5.001, DPT 5.001)
 - RGB/HSV with brightness adjustment (RGB: DPT 232.600, HSV: DPT 5.003, DPT 5.001, DPT 5.001)
 - Colour value RGBW/HSVW (RGBW: DPT 251.600, HSVW: DPT 5.003, DPT 5.001, DPT 5.001, DPT 5.001)

Object no.	Function	Name	Type	DPT	Flag
401, 425, ..., 569	Object 1 - Value transmitter - White value (W)	K <i>n</i> - Output	1-byte	5,001	C, R, -, T, A
413, 437, ..., 581	Object 2 - Value transmitter - White value (W)				

1-byte object for transmitting the white level. This is object 1 or 2 of the parameterised output objects.

i These objects are visible only with data point type | value range: colour value RGBW/HSVW (RGBW: DPT 251.600, HSVW: DPT 5.003, DPT 5.001, DPT 5.001, DPT 5.001).

Object no.	Function	Name	Type	DPT	Flag
403, 427, ..., 571	Object 1 - Value transmitter - Brightness value (V) - Status	K <i>n</i> - Input	1-byte	5,001	C, -, W, -, U
415, 438, ..., 583	Object 2 - Value transmitter - Brightness value (V) - Status				

1-byte object for receiving the brightness value. This is object 1 or 2 of the parameterised output objects.

i These objects are only visible with the following configuration:

- Data point type | value range: RGB/HSV with brightness adjustment (RGB: DPT 232.600, HSV: DPT 5.003, DPT 5.001, DPT 5.001)
- "Start value" parameter = as value from brightness (V) status object

Object no.	Function	Name	Type	DPT	Flag
403, 427, ..., 571	Object 1 - Value transmitter - Colour hue (H) - Status	K <i>n</i> - Input	1-byte	5,003	C, -, W, -, U
415, 438, ..., 583	Object 2 - Value transmitter - Colour hue (H) - Status				

1-byte object for receiving the colour hue. This is object 1 or 2 of the parameterised output objects.

i These objects are only visible with the following configuration:

- Data point type | value range: RGB/HSV with colour wheel sequence (RGB: DPT 232.600, HSV: DPT 5.003, DPT 5.001, DPT 5.001)
- "Start value" parameter = as value from colour hue (H) status object

Object no.	Function	Name	Type	DPT	Flag
403, 427, ..., 571	Object 1 - Value transmitter - RGB - Status	K n - Input	3-byte	232,600	C, -, W, -, U
415, 438, ..., 583	Object 2 - Value transmitter - RGB - Status				

3-byte object for receiving 3-byte colour information. This is object 1 or 2 of the parameterised output objects.



These objects are only visible with the following configuration:

- Parameter: data point type | value range: RGB/HSV with brightness adjustment (RGB: DPT 232.600, HSV: DPT 5.003, DPT 5.001, DPT 5.001), RGB/HSV with colour wheel sequence (RGB: DPT 232.600, HSV: DPT 5.003, DPT 5.001, DPT 5.001).

- "Start value" parameter = as value from RGB status object

Object no.	Function	Name	Type	DPT	Flag
408, 432, ..., 576	Object 1 - Value transmitter - Disabling	K n - Input	1-bit	1,003	C, -, W, -, U
420, 444, ..., 588	Object 2 - Value transmitter - Disabling				

1-bit object for activating or deactivating the disabling function. The object polarity can be parameterised. This is object 1 or 2 of the parameterised output objects.

8.2.5 Scene extension

In the "switch" channel function, each object of the switch can be parameterised separately for the "scene extension" function. The ETS indicates up to two communication objects for each switch channel output object for the "scene extension" function. The parameters can be used to determine which value the "scene extension" object receives when the contact is closed and/or opened. Furthermore, the behaviour of the switch channel output object after the bus voltage returns can be parameterised and a disabling function activated. The switching status of the switch channel output objects can be transmitted cyclically on the bus. No distinction is made between a brief or long press.

In the scene extension function, the device either calls a parameterised scene number (1...64) or switches between two scenes when the contact is closed or opened. This makes it possible to recall scenes stored in other devices.

Setting options when closing or opening the contact:

- Recall scene: results in simply recalling the scene.
- Switch over scene: The input option for a second scene number (1...64) appears. The two entered scene numbers are switched to and from each time the contact is closed or opened.

i This function can be used to call up to four different scenes if the switch is switched four times (Close - Open - Close - Open) if "Switch over scenes" is parameterised for "When closing the contact" and "When opening the contact".

8.2.5.1 Table of parameters

The following parameters are available in the "switch" channel function with the parameterised "scene extension" function for each switch channel output object.

When closing the contact	Recall scene Switch over scene
<p>The functionality of the scene extension when closing the contact of the switch is set here.</p> <p>Recall scene: results in simply recalling the scene.</p> <p>Switch over scene: The input option for a second scene number (1...64) appears. The two entered scene numbers are switched to and from each time the contact is closed.</p> <p>i The device transmits a telegram with the respective scene number on the bus.</p>	
Scene number	1...64
<p>According to the KNX standard, objects with data type 18.001 "Scene Control" can call up to 64 scenes by their numbers. The scene number to be transmitted when closing the contact is defined here.</p> <p>The input of the scene number is available only if "When closing the contact = Call scene".</p>	
First scene number	1...64
<p>According to the KNX standard, objects with data type 18.001 "Scene Control" can call up to 64 scenes by their numbers. The scene number to be transmitted when closing the contact is defined here.</p> <p>The input of the first scene number is available only if "When closing the contact = Switch over scene".</p>	
Second scene number	1, 2 ... 64
<p>According to the KNX standard, objects with data type 18.001 "Scene Control" can call up to 64 scenes by their numbers. The scene number to be transmitted when closing the contact is defined here.</p> <p>The input of the second scene number is available only if "When closing the contact = Switch over scene".</p>	

When opening the contact	Recall scene Switch over scene
<p>The functionality of the scene extension when opening the contact of the switch is set here.</p> <p>Recall scene: results in simply recalling the scene.</p> <p>Switch over scene: The input option for a second scene number (1...64) appears. The two entered scene numbers are switched to and from each time the contact is opened.</p> <p>i The device transmits a telegram with the respective scene number on the bus.</p>	

Scene number	1...64
<p>According to the KNX standard, objects with data type 18.001 "Scene Control" can call up to 64 scenes by their numbers. The scene number to be transmitted when opening the contact is defined here.</p> <p>The input of the scene number is available only if "When closing the contact = Call scene".</p>	

First scene number	1...64
<p>According to the KNX standard, objects with data type 18.001 "Scene Control" can call up to 64 scenes by their numbers. The scene number to be transmitted when opening the contact is defined here.</p> <p>The input of the first scene number is available only if "When closing the contact = Switch over scene".</p>	

Second scene number	1, 2 ... 64
<p>According to the KNX standard, objects with data type 18.001 "Scene Control" can call up to 64 scenes by their numbers. The scene number to be transmitted when opening the contact is defined here.</p> <p>The input of the second scene number is available only if "When closing the contact = Switch over scene".</p>	

After bus voltage return	no reaction Transmit current state Recall scene
<p>This parameter determines the reaction after the bus voltage returns.</p> <p>Either no telegram, a telegram according to the current input state at the channel or a parameterised scene number is transmitted on the bus according to the parameterisation.</p> <p>The reaction after the bus voltage returns takes place only after the parameterised "delay after bus voltage returns" expires ("General" parameter page).</p>	

Scene number	1...64
The parameter defines here the scene number to be transmitted after the bus voltage returns.	
Disabling function	Inactive Active
This parameter enables the disabling function for the channel.	
At the beginning of the disabling function	no reaction Recall scene
Besides disabling the channel, the device can immediately react when the disabling occurs. This parameter defines the reaction of the channel at the beginning of the disabling.	
Scene number	1...64
The scene number to be transmitted at the beginning of the disabling is defined here.	
At the end of the disabling function	no reaction Transmit current state Recall scene
Besides disabling the channel, the device can immediately react at the end of the disabling. This parameter defines the reaction of the channel at the end of the disabling.	
Scene number	1...64
The scene number to be transmitted at the end of the disabling is defined here.	
Object polarity	0 = enabled / 1 = disable 1 = enabled / 0 = disable
This parameter defines the value of the disabling object at which the disabling function is active.	

8.2.5.2 Object list

The following communication objects are available in the "switch" channel function with the parameterised "scene extension" function. The name can be adjusted with the "Name" parameter.

Object no.	Function	Name	Type	DPT	Flag
590, 598, ..., 646	Object 1 - Scene extension - Scene number	K <i>n</i> - Output	1-byte	18,001	C, R, -, T, A

1-byte object for recalling, switching over or storing one of a maximum of 64 scenes at a scene push-button sensor. This is object 1 of the parameterised output objects.

Object no.	Function	Name	Type	DPT	Flag
591, 599, ..., 647	Object 1 - Scene extension - Disabling	K <i>n</i> - Input	1-bit	1,003	C, -, W, -, U

1-bit object for activating or deactivating the disabling function. The object polarity can be parameterised. This is object 1 of the parameterised output objects.

Object no.	Function	Name	Type	DPT	Flag
594, 602, ..., 650	Object 2 - Scene extension - Scene number	K <i>n</i> - Output	1-byte	18,001	C, R, -, T, A

1-byte object for recalling, switching over or storing one of a maximum of 64 scenes at a scene push-button sensor. This is object 2 of the parameterised output objects.

Object no.	Function	Name	Type	DPT	Flag
595, 603, ..., 651	Object 2 - Scene extension - Disabling	K <i>n</i> - Input	1-bit	1,003	C, -, W, -, U

1-bit object for activating or deactivating the disabling function. The object polarity can be parameterised. This is object 2 of the parameterised output objects.

8.2.6 Room temperature control point

In the "switch" channel function, each object of the switch can be parameterised separately for the "room temperature control point" function. The ETS indicates up to three communication objects for each switch channel output object for the "room temperature control point" function. The parameters can be used to determine which values the "RTC control point" objects receive when the contact is closed or opened. Furthermore, the behaviour of the switch channel output object after the bus voltage returns can be parameterised and a disabling function activated. The RTC status of the switch channel output objects can be transmitted cyclically on the bus. No distinction is made between a brief or long press.

The "room temperature control point" channel function can be used to actuate a KNX room temperature controller.

The room temperature control point itself is not involved in the temperature control process. It allows the user to operate the single-room regulation from different points in the room. The room temperature control point can also be used to control central heating control devices located, for example, in a sub-distribution unit.

Typical KNX room temperature controllers generally offer different ways of influencing the room temperature control:

- Operating mode switchover:
Switching between different modes of operation (e. g. "Comfort", "Night" ...) with different setpoint temperatures assigned to each mode by the controller.
- Presence function:
Signalling the presence of a person in a room. The signalling may also be combined with a configured switchover in the mode of operation.
- Target temperature shift:
Adjustment of the target temperature via a temperature offset (DPT 9.002) or via levels (DPT 6.010).

The room temperature control point is operated by the switch functions of the device. In this way, it is possible to completely control a room temperature controller by changing the operating mode, specifying the presence function or adjusting the target temperature shift.

8.2.6.1 Operating mode switchover

Switchover of the controller operating mode can be effected in accordance with the standard function block for room temperature controllers defined in the KNX handbook using two 1-byte communication objects. The operating mode can be switched over with the normal and with the forced objects. The objects "RTC control point - Operating mode" enable the following modes to be selected:

- Comfort
- Standby
- Night
- Frost/heat protection

- Switchover: comfort/standby
- Switchover: comfort/night
- Switchover: standby/night
- Switchover: comfort/standby/night

The communication object "RTC control point - Operating mode - Forcing" is of higher priority. It permits forced switching between the following modes of operation:

- Forcing inactive (auto)
- Comfort
- Standby
- Night
- Frost/heat protection
- Switchover: comfort/standby
- Switchover: comfort/night
- Switchover: standby/night
- Switchover: comfort/standby/night
- Toggle: forced inactive (auto) / comfort
- Toggle: forced inactive (auto) / standby
- Toggle: forced inactive (auto) / night
- Switchover: forced inactive (auto) / frost/heat protection

The operating mode transmitted on the bus when closing or opening the switch of the room temperature control point is defined by the parameters "When closing the contact" and "When opening the contact". It is possible that either one of the above modes is called up or two or three modes are switched between.

8.2.6.2 Presence function

All channels whose functionality is set to "presence function" have the two communication objects "RTC control point - Presence" and "RTC control point - Presence - Status". The parameters "When closing the contact" and "When opening the contact" determine the object value transmitted on the bus when closing or opening the contact.

8.2.6.3 Target temperature shift

Another function of the room temperature control point that is available is the target temperature shift. It makes use of either two 2-byte communication objects with datapoint type 9.002 or two 1-byte communication objects with datapoint type 6.010 (integer with sign).

This control point function allows the basic setpoint temperature to be shifted on a room temperature controller by closing or opening the contact. The control point is usually operated in the same way as the main control point. A switch output object parameterised as setpoint temperature shift reduces or increases the setpoint tem-

perature shift value once each time the contact is closed or opened. The direction of the value adjustment is defined by the parameters "When closing the contact" and "When opening the contact".

Communication with main controller

To enable the device to shift the target temperature on a room temperature controller, the controller must have input and output objects for the target temperature shift. In this case, the output object of the controller must be connected to the input object of the room temperature control point, and the input object of the controller must be connected to the output object of the room temperature control point in each case via their own group address.

All objects are of the same datapoint type and have the same value range. A target temperature shift is interpreted by count values: a shift in positive direction is expressed by positive values, whereas a shift in negative direction is represented by negative object values. An object value of "0" means that no target temperature shift has been set.

The room temperature control points detect the current position of the setpoint adjustment by means of the object "RTC control point - Target temperature shift - Status" of the room temperature control point connected to the room temperature controller. Starting from the value of the communication object, the setpoint is adjusted in the configured direction each time a button is pressed on a room temperature control point. Each time the setpoint is adjusted, the new shift by means of the object "RTC control point - Target temperature shift" of the room temperature control point is sent to the room temperature regulator.

With the "by counter value" function, the individual levels are weighted by the controller itself.

This requires that the respective communication objects are connected to all room temperature control points and the controller. The feedback information from the controller enables the room temperature control point to continue the adjustment at any time at the right point.

8.2.6.4 Table of parameters

The following parameters are available in the "switch" channel function with the parameterised "room temperature control point" function for each switch channel output object.

Function	Operating mode switchover Forced oper. mode switchover Presence function Target temperature shift
A room temperature control point can optionally switch over (force) the operating mode with normal or high priority, change the presence status or change the current room temperature setpoint value. With regard to the setting of this parameter, the ETS shows further parameters.	
When closing the contact	Comfort Standby Night Frost/heat protection Switchover: comfort/standby Switchover: comfort/night Switchover: standby/night Switchover: comfort/standby/night
If the room temperature control point is intended to change over the operating mode of the room temperature controller with normal priority, the extension can either switch on a defined operating mode or switch between different operating modes when the contact is closed.	
When opening the contact	Comfort Standby Night Frost/heat protection Switchover: comfort/standby Switchover: comfort/night Switchover: standby/night Switchover: comfort/standby/night
If the room temperature control point is intended to change over the operating mode of the room temperature controller with normal priority, the extension can either switch on a defined operating mode or switch between different operating modes when the contact is opened.	

When closing the contact	Forcing inactive (auto) Comfort Standby Night Frost/heat protection Switchover: comfort/standby Switchover: comfort/night Switchover: standby/night Switchover: comfort/standby/night Toggle: forced inactive (auto) / comfort Toggle: forced inactive (auto) / standby Toggle: forced inactive (auto) / night Switchover: forced inactive (auto) / frost/heat protection
--------------------------	--

If the room temperature control point is intended to switch the operating mode of the room temperature controller with high priority, the extension can either enable the change-over with normal priority (auto), switch on a defined operating mode with high priority or switch between different operating modes when the contact is closed.

When opening the contact	Forcing inactive (auto) Comfort Standby Night Frost/heat protection Switchover: comfort/standby Switchover: comfort/night Switchover: standby/night Switchover: comfort/standby/night Toggle: forced inactive (auto) / comfort Toggle: forced inactive (auto) / standby Toggle: forced inactive (auto) / night Switchover: forced inactive (auto) / frost/heat protection
--------------------------	--

If the room temperature control point is intended to switch the operating mode of the room temperature controller with high priority, the extension can either enable the change-over with normal priority (auto), switch on a defined operating mode with high priority or switch between different operating modes when the contact is opened.

When closing the contact	Presence ON Presence OFF Presence TOGGLE
The room temperature control point can switch the presence state of the room temperature controller either on or off in a defined way or the extension can switch between both states ("Presence TOGGLE") when the contact is closed. This parameter is only visible if "Function = presence function".	
When opening the contact	Presence ON Presence OFF Presence TOGGLE
The room temperature control point can switch the presence state of the room temperature controller either on or off in a defined way or the extension can switch between both states ("Presence TOGGLE") when the contact is opened. This parameter is only visible if "Function = presence function".	
Target temperature shift	By relative temperature value By meter value
Depending on the setting of the "Target temperature shift" parameter, the shift takes place by means of the 2-byte communication object in accordance with KNX DPT 9.002 or KNX DPT 6.010. This parameter is visible only if "function = target temperature shift".	
When closing the contact	+2 K +1.5 K +1 K +0.5 K -0.5 K -1 K -1.5 K -2 K
The temperature difference is defined in Kelvin here by which the setpoint temperature will be shifted up or down when the contact is closed. To shift the target temperature value, the room temperature control point uses the two communication objects "RTC control point - Target temperature shift" and "RTC control point - Target temperature shift - Status". The communication object "RTC control point - Target temperature shift - Status" informs the room temperature control point about the current state of the room temperature controller. Based on this value and the parameter here, the room temperature control point calculates the new level value, which it sends to the room temperature controller via the communication object "RTC control point - Target temperature shift". This parameter is visible only if "Functionality = setpoint temperature shift" and "Setpoint temperature shift = by relative temperature value".	

When opening the contact	+2 K +1.5 K +1 K +0.5 K -0.5 K -1 K -1.5 K -2 K
--------------------------	---

The difference in temperature by which the setpoint temperature is shifted up or down when the contact is opened is defined in Kelvin here.

To shift the target temperature value, the room temperature control point uses the two communication objects "RTC control point - Target temperature shift" and "RTC control point - Target temperature shift - Status".

The communication object "RTC control point - Target temperature shift - Status" informs the room temperature control point about the current state of the room temperature controller. Based on this value and the parameter here, the room temperature control point calculates the new level value, which it sends to the room temperature controller via the communication object "RTC control point - Target temperature shift".

This parameter is visible only if "Functionality = setpoint temperature shift" and "Setpoint temperature shift = by relative temperature value".

When closing the contact	Increase setpoint temperature Reduce setpoint temperature
--------------------------	---

The direction of the target temperature shift is defined here at the room temperature control point.

To shift the target temperature value, the room temperature control point uses the two communication objects "RTC control point - Target temperature shift" and "RTC control point - Target temperature shift - Status".

The communication object "RTC control point - Target temperature shift - Status" informs the extension about the current state of the room temperature controller. Based on this value and the parameter here, the room temperature control point calculates the new level value, which it sends to the room temperature controller via the communication object "RTC control point - Target temperature shift".

This parameter is visible only if "function = target temperature shift" and "type of target temperature shift = above meter value".

When opening the contact	Increase setpoint temperature Reduce setpoint temperature
<p>The direction of the target temperature shift is defined here at the room temperature control point.</p> <p>To shift the target temperature value, the room temperature control point uses the two communication objects "RTC control point - Target temperature shift" and "RTC control point - Target temperature shift - Status".</p> <p>The communication object "RTC control point - Target temperature shift - Status" informs the extension about the current state of the room temperature controller. Based on this value and the parameter here, the room temperature control point calculates the new level value, which it sends to the room temperature controller via the communication object "RTC control point - Target temperature shift".</p> <p>This parameter is visible only if "function = target temperature shift" and "type of target temperature shift = above meter value".</p>	

After bus voltage return	no reaction Transmit current state Comfort Standby Night Frost/heat protection
<p>This parameter determines the reaction after the bus voltage returns.</p> <p>Either no telegram, a telegram according to the current input state at the channel, a comfort telegram, a standby telegram, a night telegram or a frost/heat protection telegram is transmitted on the bus according to the parameterisation.</p> <p>The reaction after the bus voltage returns takes place only after the parameterised "delay after bus voltage returns" expires ("General" parameter page).</p> <p>Visible only if "Functionality = operating mode change-over".</p>	

After bus voltage return	no reaction Transmit current state Forcing inactive (auto) Comfort Standby Night Frost/heat protection
--------------------------	---

This parameter determines the reaction after the bus voltage returns.

Either no telegram, a telegram according to the current input state at the channel, a forcing inactive (auto) telegram, a comfort telegram, a standby telegram, a night telegram or a frost/heat protection telegram is transmitted on the bus according to the parameterisation.

The reaction after the bus voltage returns takes place only after the parameterised "delay after bus voltage returns" expires ("General" parameter page).

Visible only if "Functionality = forced operating mode change-over".

After bus voltage return	no reaction Transmit current state Presence ON Presence OFF Presence TOGGLE
--------------------------	--

This parameter determines the reaction after the bus voltage returns.

Either no telegram, a telegram according to the current input state at the channel or a presence telegram is transmitted on the bus according to the parameterisation.

The reaction after the bus voltage returns takes place only after the parameterised "delay after bus voltage returns" expires ("General" parameter page).

This parameter is only visible if "Function = presence function".

After bus voltage return	no reaction +2 K +1.5 K +1 K +0.5 K -0.5 K -1 K -1.5 K -2 K
--------------------------	--

This parameter determines the reaction after the bus voltage returns.
 Either no telegram or a temperature value telegram is transmitted on the bus according to the parameterisation.
 The reaction after the bus voltage returns takes place only after the parameterised "delay after bus voltage returns" expires ("General" parameter page).
 This parameter is visible only if "Functionality = setpoint temperature shift" and "Setpoint temperature shift = by relative temperature value".

After bus voltage return	no reaction Increase setpoint temperature Reduce setpoint temperature
--------------------------	--

This parameter determines the reaction after the bus voltage returns.
 Either no telegram or a counting value telegram is transmitted on the bus according to the parameterisation.
 The reaction after the bus voltage returns takes place only after the parameterised "delay after bus voltage returns" expires ("General" parameter page).
 This parameter is visible only if "function = target temperature shift" and "type of target temperature shift = above meter value".

Send operating mode cyclically	Inactive Active
--------------------------------	---------------------------

The switching status of the switch channel output objects can be transmitted cyclically on the bus.
 This parameter enables the cyclical transmission.
 Visible only if "Functionality = operating mode change-over".

Send forced operation mode cyclically	Inactive Active
---------------------------------------	---------------------------

The switching status of the switch channel output objects can be transmitted cyclically on the bus.
 This parameter enables the cyclical transmission.
 Visible only if "Functionality = forced operating mode change-over".

Send presence status cyclically	Inactive Active
<p>The switching status of the switch channel output objects can be transmitted cyclically on the bus.</p> <p>This parameter enables the cyclical transmission.</p> <p>This parameter is only visible if "Function = presence function".</p>	
Send target temperature shift cyclically	Inactive Active
<p>The switching status of the switch channel output objects can be transmitted cyclically on the bus.</p> <p>This parameter enables the cyclical transmission.</p> <p>This parameter is visible only if "function = target temperature shift".</p>	
Cycle time	0...24 h 0...5...59 min 0...59 s
<p>This parameter defines the interval at which the switching status is transmitted on the bus.</p> <p>The cycle time can be parameterised between 3 seconds and 24 hours.</p>	
Disabling function	Inactive Active
<p>This parameter enables the disabling function for the channel.</p>	
At the beginning of the disabling function	no reaction Comfort Standby Night Frost/heat protection
<p>Besides disabling the channel, the device can immediately react when the disabling occurs.</p> <p>This parameter defines the reaction of the channel at the beginning of the disabling.</p> <p>Visible only if "Functionality = operating mode change-over".</p>	

At the beginning of the disabling function	no reaction Forcing inactive (auto) Comfort Standby Night Frost/heat protection
--	---

Besides disabling the channel, the device can immediately react when the disabling occurs.

This parameter defines the reaction of the channel at the beginning of the disabling. Visible only if "Functionality = forced operating mode change-over".

At the beginning of the disabling function	no reaction Presence ON Presence OFF Presence TOGGLE
--	--

Besides disabling the channel, the device can immediately react when the disabling occurs.

This parameter defines the reaction of the channel at the beginning of the disabling. This parameter is only visible if "Function = presence function".

At the beginning of the disabling function	no reaction +2 K +1.5 K +1 K +0.5 K -0.5 K -1 K -1.5 K -2 K
--	--

Besides disabling the channel, the device can immediately react when the disabling occurs.

This parameter defines the reaction of the channel at the beginning of the disabling. This parameter is visible only if "Functionality = setpoint temperature shift" and "Setpoint temperature shift = by relative temperature value".

At the beginning of the disabling function	no reaction Increase setpoint temperature Reduce setpoint temperature
Besides disabling the channel, the device can immediately react when the disabling occurs. This parameter defines the reaction of the channel at the beginning of the disabling. This parameter is visible only if "function = target temperature shift" and "type of target temperature shift = above meter value".	
At the end of the disabling function	no reaction Transmit current state Comfort Standby Night Frost/heat protection
Besides disabling the channel, the device can immediately react at the end of the disabling. This parameter defines the reaction of the channel at the end of the disabling. Visible only if "Functionality = operating mode change-over".	
At the end of the disabling function	no reaction Transmit current state Forcing inactive (auto) Comfort Standby Night Frost/heat protection
Besides disabling the channel, the device can immediately react at the end of the disabling. This parameter defines the reaction of the channel at the end of the disabling. Visible only if "Functionality = forced operating mode change-over".	
At the end of the disabling function	no reaction Transmit current state Presence ON Presence OFF Presence TOGGLE
Besides disabling the channel, the device can immediately react at the end of the disabling. This parameter defines the reaction of the channel at the end of the disabling. This parameter is only visible if "Function = presence function".	

At the end of the disabling function	no reaction +2 K +1.5 K +1 K +0.5 K -0.5 K -1 K -1.5 K -2 K
Besides disabling the channel, the device can immediately react at the end of the disabling. This parameter defines the reaction of the channel at the end of the disabling. This parameter is visible only if "Functionality = setpoint temperature shift" and "Setpoint temperature shift = by relative temperature value".	
At the end of the disabling function	no reaction Increase setpoint temperature Reduce setpoint temperature
Besides disabling the channel, the device can immediately react at the end of the disabling. This parameter defines the reaction of the channel at the end of the disabling. This parameter is visible only if "function = target temperature shift" and "type of target temperature shift = above meter value".	
Object polarity	0 = enabled / 1 = disable 1 = enabled / 0 = disable
This parameter defines the value of the disabling object at which the disabling function is active.	

8.2.6.5 Object list

The following communication objects are available in the "switch" channel function with the parameterised "room temperature control point" function. The name can be adjusted with the "Name" parameter.

Object no.	Function	Name	Type	DPT	Flag
966, 980, ..., 1064	Object 1 - RTC control point - Operating mode	K n - Output	1-byte	20,102	C, R, -, T, A

1-byte object for switching a room temperature controller between the Comfort, Standby, Night and Frost/heat protection operating modes. This is object 1 of the parameterised output objects.

This object is only visible if "Function = operating mode switchover".

Object no.	Function	Name	Type	DPT	Flag
967, 981, ..., 1065	Object 1 - RTC control point - Operating mode - Status	K n - Input	1-byte	20,102	C, -, W, -, U

1-byte object for receiving the operating mode of a room temperature controller. This is object 1 of the parameterised output objects.

This object is only visible if "Function = operating mode switchover".

Object no.	Function	Name	Type	DPT	Flag
966, 980, ..., 1064	Object 1 - RTC control point - Operating mode - Forced	K n - Output	1-byte	20,102	C, R, -, T, A

1-byte object for switching a room temperature controller under forced control between the Automatic, Comfort, Standby, Night and Frost / heat protection operating modes. This is object 1 of the parameterised output objects.

This object is only visible if "Function = forced operating mode switchover".

Object no.	Function	Name	Type	DPT	Flag
967, 981, ..., 1065	Object 1 - RTC control point - Operating mode - Forcing - Status	K n - Input	1-byte	20,102	C, -, W, -, U

1-byte object for receiving the operating mode of a room temperature controller. This is object 1 of the parameterised output objects.

This object is only visible if "Function = forced operating mode switchover".

Object no.	Function	Name	Type	DPT	Flag
966, 980, ..., 1064	Object 1 - RTC control point - Presence	K <i>n</i> - Output	1-bit	1,018	C, R, -, T, A

1-bit object for changing over the presence status of a room temperature controller. This is object 1 of the parameterised output objects.

This object is only visible if "Function = presence function".

Object no.	Function	Name	Type	DPT	Flag
967, 981, ..., 1065	Object 1 - RTC control point - Presence - Status	K <i>n</i> - Input	1-bit	1,018	C, -, W, -, U

1-bit object for receiving the presence status of a room temperature controller. This is object 1 of the parameterised output objects.

This object is only visible if "Function = presence function".

Object no.	Function	Name	Type	DPT	Flag
966, 980, ..., 1064	Object 1 - RTC control point - Target temperature shift	K <i>n</i> - Output	2-byte	9,002	C, R, -, T, A

2-byte object for specification of a target temperature shift in Kelvin. The value "0" means that no shift is active. Values can be specified between -670760 K and 670760 K. This is object 1 of the parameterised output objects.

This object is visible only if "function = target temperature shift" and "type of target temperature shift = above relative temperature value".

Object no.	Function	Name	Type	DPT	Flag
967, 981, ..., 1065	Object 1 - RTC control point - Target temperature shift - Status	K <i>n</i> - Input	2-byte	9,002	C, -, W, -, U

2-byte object for receiving the status of the current target temperature shift in Kelvin. This is object 1 of the parameterised output objects.

This object is visible only if "function = target temperature shift" and "type of target temperature shift = above relative temperature value".

Object no.	Function	Name	Type	DPT	Flag
966, 980, ..., 1064	Object 1 - RTC control point - Target temperature shift	K <i>n</i> - Output	1-byte	6,010	C, R, -, T, A

1-byte object for specification of a target temperature shift. The value "0" means that no shift is active. The value is depicted in a two's complement in the positive or negative direction. This is object 1 of the parameterised output objects.

This object is visible only if "function = target temperature shift" and "type of target temperature shift = above meter value".

Object no.	Function	Name	Type	DPT	Flag
967, 981, ..., 1065	Object 1 - RTC control point - Target temperature shift - Status	K <i>n</i> - Input	1-byte	6,010	C, -, W, -, U
<p>1-byte object to receive the status of the current target temperature shift. This is object 1 of the parameterised output objects.</p> <p>This object is visible only if "function = target temperature shift" and "type of target temperature shift = above meter value".</p>					
Object no.	Function	Name	Type	DPT	Flag
968, 982, ..., 1066	Object 1 - RTC control panel - Disabling	K <i>n</i> - Input	1-bit	1,003	C, -, W, -, U
<p>1-bit object for activating or deactivating the disabling function. The object polarity can be parameterised. This is object 1 of the parameterised output objects.</p>					
Object no.	Function	Name	Type	DPT	Flag
973, 987, ..., 1071	Object 2 - RTC control point - Operating mode	K <i>n</i> - Output	1-byte	20,102	C, R, -, T, A
<p>1-byte object for switching a room temperature controller between the Comfort, Standby, Night and Frost/heat protection operating modes. This is object 2 of the parameterised output objects.</p> <p>This object is only visible if "Function = operating mode switchover".</p>					
Object no.	Function	Name	Type	DPT	Flag
974, 988, ..., 1072	Object 2 - RTC control point - Operating mode - Status	K <i>n</i> - Input	1-byte	20,102	C, -, W, -, U
<p>1-byte object for receiving the operating mode of a room temperature controller. This is object 2 of the parameterised output objects.</p> <p>This object is only visible if "Function = operating mode switchover".</p>					
Object no.	Function	Name	Type	DPT	Flag
973, 987, ..., 1071	Object 2 - RTC control point - Operating mode - Forced	K <i>n</i> - Output	1-byte	20,102	C, R, -, T, A
<p>1-byte object for switching a room temperature controller under forced control between the Automatic, Comfort, Standby, Night and Frost / heat protection operating modes. This is object 2 of the parameterised output objects.</p> <p>This object is only visible if "Function = forced operating mode switchover".</p>					

Object no.	Function	Name	Type	DPT	Flag
974, 988, ..., 1072	Object 2 - RTC control point - Operating mode - Forcing - Status	K <i>n</i> - Input	1-byte	20,102	C, -, W, -, U
<p>1-byte object for receiving the operating mode of a room temperature controller. This is object 2 of the parameterised output objects.</p> <p>This object is only visible if "Function = forced operating mode switchover".</p>					

Object no.	Function	Name	Type	DPT	Flag
973, 987, ..., 1071	Object 2 - RTC control point - Presence	K <i>n</i> - Output	1-bit	1,018	C, R, -, T, A
<p>1-bit object for changing over the presence status of a room temperature controller. This is object 2 of the parameterised output objects.</p> <p>This object is only visible if "Function = presence function".</p>					

Object no.	Function	Name	Type	DPT	Flag
974, 988, ..., 1072	Object 2 - RTC control point - Presence - Status	K <i>n</i> - Input	1-bit	1,018	C, -, W, -, U
<p>1-bit object for receiving the presence status of a room temperature controller. This is object 2 of the parameterised output objects.</p> <p>This object is only visible if "Function = presence function".</p>					

Object no.	Function	Name	Type	DPT	Flag
973, 987, ..., 1071	Object 2 - RTC control point - Target temperature shift	K <i>n</i> - Output	2-byte	9,002	C, R, -, T, A
<p>2-byte object for specification of a target temperature shift in Kelvin. The value "0" means that no shift is active . Values can be specified between -670760 K and 670760 K. This is object 2 of the parameterised output objects.</p> <p>This object is visible only if "function = target temperature shift" and "type of target temperature shift = above relative temperature value".</p>					

Object no.	Function	Name	Type	DPT	Flag
974, 988, ..., 1072	Object 2 - RTC control point - Target temperature shift - Status	K <i>n</i> - Input	2-byte	9,002	C, -, W, -, U
<p>2-byte object for receiving the status of the current target temperature shift in Kelvin. This is object 2 of the parameterised output objects.</p> <p>This object is visible only if "function = target temperature shift" and "type of target temperature shift = above relative temperature value".</p>					

Object no.	Function	Name	Type	DPT	Flag
973, 987, ..., 1071	Object 2 - RTC control point - Target temperature shift	K n - Output	1-byte	6,010	C, R, -, T, A
<p>1-byte object for specification of a target temperature shift. The value "0" means that no shift is active . The value is depicted in a two's complement in the positive or negative direction. This is object 2 of the parameterised output objects.</p> <p>This object is visible only if "function = target temperature shift" and "type of target temperature shift = above meter value".</p>					
Object no.	Function	Name	Type	DPT	Flag
974, 988, ..., 1072	Object 2 - RTC control point - Target temperature shift - Status	K n - Input	1-byte	6,010	C, -, W, -, U
<p>1-byte object to receive the status of the current target temperature shift. This is object 2 of the parameterised output objects.</p> <p>This object is visible only if "function = target temperature shift" and "type of target temperature shift = above meter value".</p>					
Object no.	Function	Name	Type	DPT	Flag
975, 989, ..., 1073	Object 2 - RTC control panel - Disabling	K n - Input	1-bit	1,003	C, -, W, -, U
<p>1-bit object for activating or deactivating the disabling function. The object polarity can be parameterised. This is object 2 of the parameterised output objects.</p>					

8.3 Door/window status

The channel function can be parameterised for each channel. The device can indicate a door/window status in combination with a sensor connected to the channel. In the "door/window status" channel function, the device indicates a door/window status on the bus by means of an output object according to the parameterisation.

- i** The door/window status is transmitted in compressed form on the bus by the 2-byte object "Door/window status - Overall state - Status". The status can be interpreted and indicated by means of visualisation.
- i** In addition, a door or window number can be assigned, with the effect that the status information is supplemented for visualisation by means of the object "Door/window status - Door/window number".

The ETS provides the suitable parameters for the function and up to five communication objects dynamically according to the parameterised function.

The following states are available for evaluation of a window sash:

- open
- closed
- Tilted
- Unknown

The following states are available for evaluation of a window handle:

- open
- closed
- Tilted
- Unknown

The following states are available for evaluation of a door leaf:

- open
- closed
- Unknown

The following states are available for evaluation of a door handle:

- Locked
- Unlocked
- Unknown

Door/window status in the single channel configuration

A contact can be evaluated in the single channel configuration. The "0" and "1" states can be evaluated. The meaning of the evaluated states can be parameterised flexibly in a table.

Door/window status in the combined channel configuration

Two contacts can be evaluated in the combined channel configuration. The "0" and "1" states can be evaluated separately for each contact. Contact 1 and contact 2 can be flexibly assigned to channels 1 and 2. The meaning of the evaluated states can be parameterised flexibly in a table.

Two channels, for example each with a magnetic contact, can be used. They can be used in the top and bottom window area, which allows the closed, open or tilted window status to be evaluated in combination.

Evaluation of the 2-byte object "Door/window status - Overall status - Status"

The device transmits suitable telegrams by means of the 2-byte object "Door/window status - Overall state - Status" on the bus according to the parameterisation.

The individual bits of the 2-byte object "Door/window status - Overall status - Status" have the following meaning...

Bit of the status object	Meaning
0 ... 2	"0" = undefined, "1" = leaf/sash closed, "2" = leaf/sash tilted, "3" = leaf/sash open
3 ... 5	"0" = undefined, "1" = handle closed, "2" = handle tilted, "3" = handle open
6 ... 7	"0" = undefined, "1" = closure unlocked, "2" = closure locked
8	"0" = no leaf/sash status, "1" leaf/sash status used
9	"0" = no handle status, "1" handle used status
10	"0" = no closure status, "1" closure used status
11	"0" = window, "1" = door
12	not used (permanent "0")
13	not used (permanent "0")
14	not used (permanent "0")
15	not used (permanent "0")

Advanced settings

An evaluation delay, an additional 1-bit status object, a debouncing time and the object polarity can be defined in the advanced parameters.

At the end of the evaluation delay, the device transmits the evaluated state on the bus.

An additional 1-bit status object can transmit the state of the contact according to the object polarity on the bus.

8.3.1 Table of parameters

The following parameters are available in the "door/window status" channel function.

Element	Window Door
This parameter defines the sub-element whose status is to be evaluated.	
Evaluation	Wing Handle
This parameter defines the sub-element whose status is to be evaluated. Visible only if the "Window" element has been parameterised.	
Evaluation	Wing Closure
This parameter defines the sub-element whose status is to be evaluated. Visible only if the "Door" element has been parameterised.	
Window number assigned	Active Inactive
The window element to be evaluated can be assigned an identifiable window number if this parameter is activated. Visible only if the "Window" element has been parameterised.	
Number	0 ... 4294967295
This parameter defines the identifiable window number. The window number is transmitted on the bus if the status is changed by means of a communication object.	
Door number assigned	Active Inactive
The door element to be evaluated can be assigned an identifiable door number if this parameter is activated. Visible only if the "Door" element has been parameterised.	
Number	0 ... 4294967295
This parameter defines the identifiable door number. The door number is transmitted on the bus in the event of a status change by means of a communication object.	
Name of contact 1	Free text
The text entered in this parameter is used to label the contact in the ETS parameter window (e. g. "Living room window", "Bathroom door"). The text is not programmed in the device.	

Leaf/sash (contact 1 = 0)	open closed Tilted Unknown
---------------------------	-------------------------------------

This parameter in the table "Evaluation of the states" defines the state if contact 1 of the window sash is "0". The object polarity can be parameterised in the advanced parameters.

Leaf/sash (contact 1 = 1)	open closed Tilted Unknown
---------------------------	--

This parameter in the table "Evaluation of the states" defines the state if contact 1 of the window sash is "1". The object polarity can be parameterised in the advanced parameters.

Handle (contact 1 = 0)	open closed Tilted Unknown
------------------------	-------------------------------------

This parameter in the table "Evaluation of the states" defines the state if contact 1 of the window handle is "0". The object polarity can be parameterised in the advanced parameters.

Handle (contact 1 = 1)	open closed Tilted Unknown
------------------------	--

This parameter in the table "Evaluation of the states" defines the state if contact 1 of the window handle is "1". The object polarity can be parameterised in the advanced parameters.

Leaf/sash (contact 1 = 0)	open closed Unknown
---------------------------	---------------------------

This parameter in the table "Evaluation of the states" defines the state if contact 1 of the door leaf is "0". The object polarity can be parameterised in the advanced parameters.

Leaf/sash (contact 1 = 1)	open closed Unknown
This parameter in the table "Evaluation of the states" defines the state if contact 1 of the door leaf is "1". The object polarity can be parameterised in the advanced parameters.	
Closure (contact 1 = 0)	Locked Unlocked Unknown
This parameter in the table "Evaluation of the states" defines the state if contact 1 of the door closure is "0". The object polarity can be parameterised in the advanced parameters.	
Closure (contact 1 = 1)	Locked Unlocked Unknown
This parameter in the table "Evaluation of the states" defines the state if contact 1 of the door closure is "1". The object polarity can be parameterised in the advanced parameters.	
Advanced parameters	Active Inactive
When the advanced parameters are activated, the ETS shows the following parameters. The default values of the advanced parameters are used if the advanced parameters are deactivated.	
Evaluation delay (0 = inactive)	0 ... 1 ... 59 s 0 ... 990 ms
The door/window status can be evaluated and transmitted after a delay. An evaluation delay of 1 second is activated in the default parameterisation. Visible only if "Advanced parameters = active".	
Additional 1-bit status object	Active Inactive
This parameter enables an additional 1-bit status object, which transmits the state of the contact on the bus according to the object polarity. Visible only if "Advanced parameters = active".	
Debounce time	4 ... 30 ... 255 ms
This parameter specifies the software debouncing time. A signal edge is evaluated at the input after a delay based on this time. Visible only if "Advanced parameters = active".	

Object polarity	0 = closed / 1 = open 1 = closed / 0 = open
This parameter sets the polarity of the contact for adjustment to the NO or NC contacts.	
After bus voltage return	no reaction Transmit current state
This parameter determines the reaction after the bus voltage returns. Either no telegram or a telegram according to the current input state at the channel is transmitted on the bus according to the parameterisation. The reaction after the bus voltage returns takes place only after the parameterised "delay after bus voltage returns" expires ("General" parameter page).	
Send output objects cyclically	Active Inactive
The output objects of the "door/window status" channel function can be transmitted cyclically on the bus. This parameter enables the cyclical transmission.	
Cycle time	0...24 h 0... 5 ...59 min 0...59 s
This parameter defines the interval at which the output objects are transmitted on the bus. The cycle time can be parameterised between 3 seconds and 24 hours.	
Disabling function	Inactive Active
This parameter enables the disabling function for the channel.	
At the beginning of the disabling function	no reaction Individual settings
Besides disabling the channel, the device can immediately react when the disabling occurs. This parameter defines the reaction of the channel at the beginning of the disabling.	
Wing status	open closed Tilted Unknown
This parameter defines the state at the beginning of the disabling with the individual setting.	

Handle status	open closed Tilted Unknown
This parameter defines the state at the beginning of the disabling with the individual setting.	
Wing status	open closed Unknown
This parameter defines the state at the beginning of the disabling with the individual setting.	
Handle status	Locked Unlocked Unknown
This parameter defines the state at the beginning of the disabling with the individual setting.	
At the end of the disabling function	no reaction Transmit current state
Besides disabling the channel, the device can immediately react at the end of the disabling. This parameter defines the reaction of the channel at the end of the disabling.	
Object polarity	0 = enabled / 1 = disable 1 = enabled / 0 = disable
This parameter defines the value of the disabling object at which the disabling function is active.	

8.3.2 Object list

The following communication objects are available in the "door/window status" channel function. The name can be adjusted with the "Name" parameter.

Object no.	Function	Name	Type	DPT	Flag
1087, 1101, ..., 1185	Door/window status - Contact 1 - Status	K <i>n</i> - Output	1-bit	1.001	C, R, -, T, A
1-bit object for transmission of an additional 1-bit status. This object transmits the state of the contact according to the object polarity on the bus. Visible only if the additional 1-bit status object was activated in the parameters.					

Object no.	Function	Name	Type	DPT	Flag
1091, 1105, ..., 1189	Door/window status - Overall status - Status	K <i>n</i> - Output	2-byte	---	C, R, -, T, A
2-byte object for transmission of the door/window status. <ul style="list-style-type: none"> - Bit 0...2: "0" = undefined, "1" = leaf/sash closed, "2" = leaf/sash tilted, "3" = leaf/sash open - Bit 3...5: "0" = undefined, "1" = handle closed, "2" = handle tilted, "3" = handle open - Bit 6...7: "0" = undefined, "1" = closure unlocked, "2" = closure locked - Bit 8: "0" = no leaf/sash status, "1" leaf/sash used status - Bit 9: "0" = no handle status, "1" handle used status - Bit 10: "0" = no closure status, "1" closure used status - Bit 11: "0" = window, "1" = door - Bit 12...15: not used 					

Object no.	Function	Name	Type	DPT	Flag
1092, 1106, ..., 1190	Door/window status - Disabling	K <i>n</i> - Output	1-bit	1.003	C, -, W, -, U
1-bit object for activating or deactivating the disabling function. The object polarity can be parameterised.					

Object no.	Function	Name	Type	DPT	Flag
1093, 1107, ..., 1191	Door/window status - Door/window number	K <i>n</i> - Output	4-byte	12.001	C, R, -, T, A
4-byte object for transmission of the door or window number. The door/window number is transmitted on the bus each time the status is changed. Visible only if the window number or door number was assigned in the parameters.					

8.4 Leakage/condensation sensor

The channel function can be parameterised for each channel. The device can indicate a leakage or condensation alarm in combination with a sensor connected to the channel. In the "leakage/condensation sensor" channel function, the device indicates a leakage or condensation alarm on the bus by means of an output object according to the parameterisation.

The ETS provides the appropriate parameters and up to two communication objects dynamically according to the parameterised function.

- i** If the "leakage/condensation sensor" channel function is selected, the "Delay after bus voltage return" on the "General" parameter page must be configured to be greater than or equal 5 seconds.
- i** If the "leakage/condensation sensor" channel function is selected, the "de-bouncing time" of 138 ms is optimally preset on the condensation or leakage sensor.

8.4.1 Table of parameters

The following parameters are available in the "leakage/condensation sensor" channel function.

Debounce time	4 ms ... 138 ms ... 255 ms
<p>This parameter specifies the software debouncing time. A signal edge is evaluated at the input after a delay based on this time.</p> <p>The debouncing time of 138 ms is optimally adjusted to the dew or leakage sensor.</p> <p>i The debouncing time is to be adjusted or increased in the event of false alarms.</p>	
Object polarity	1 = trigger / 0 = reset 0 = trigger / 1 = reset
<p>This parameter defines the value of the switching object at which the channel function is triggered or reset.</p>	
After bus voltage return	no reaction Transmit current state
<p>This parameter determines the reaction after the bus voltage returns.</p> <p>Either no telegram or a telegram according to the current input state at the channel is transmitted on the bus according to the parameterisation.</p> <p>The reaction after the bus voltage returns takes place only after the parameterised "delay after bus voltage returns" expires ("General" parameter page).</p>	

Send switching status cyclically	Inactive Active
<p>The switching status of the switch channel output objects can be transmitted cyclically on the bus.</p> <p>This parameter enables the cyclical transmission.</p>	
Cycle time	0...24 h 0...5...59 min 0...59 s
<p>This parameter defines the interval at which the switching status is transmitted on the bus.</p> <p>The cycle time can be parameterised between 3 seconds and 24 hours.</p>	
Disabling function	Inactive Active
<p>This parameter enables the disabling function for the channel.</p>	
At the beginning of the disabling function	no reaction
<p>The device does not immediately react when the disabling occurs.</p>	
At the end of the disabling function	no reaction Transmit current state
<p>Besides disabling the channel, the device can immediately react at the end of the disabling.</p> <p>This parameter defines the reaction of the channel at the end of the disabling.</p>	
Object polarity	0 = enabled / 1 = disable 1 = enabled / 0 = disable
<p>This parameter defines the value of the disabling object at which the disabling function is active.</p>	

8.4.2 Object list

The following communication objects are available in the "leakage/condensation sensor" channel function. The name can be adjusted with the "Name" parameter.

Object no.	Function	Name	Type	DPT	Flag
253, 261, ..., 309	Leakage and condensation sensor - Switching	K <i>n</i> - Output	1-bit	1.001	C, R, -, T, A
1-bit object for transmission of switching telegrams (ON, OFF).					

Object no.	Function	Name	Type	DPT	Flag
255, 263, ..., 311	Switching - Disabling	K <i>n</i> - Input	1-bit	1.003	C, -, W, -, U
1-bit object for activating or deactivating the disabling function. The object polarity can be parameterised.					

8.5 Temperature sensor

The "temperature sensor" channel function can be parameterised for channels 1 and 2. The device can indicate the actual temperature in combination with a sensor (see chapter "Accessories" ▶ Page 10) connected to the channel. In the "temperature sensor" channel function, the device indicates an actual temperature on the bus by means of an output object according to the parameterisation.

The ETS provides the appropriate parameters and up to three communication objects dynamically according to the parameterised function.

8.5.1 Table of parameters

The following parameters are available in the "temperature sensor" channel function.

Temperature measurement by	Connected sensor Connected sensor and ext. value via bus
<p>The "Temperature measurement by" parameter specifies the sensors used to measure the room temperature.</p> <p>"Connected sensor": The temperature sensor connected to the device channel has been activated. Thus, the actual temperature value is determined only locally on the device. In this configuration, the feedback control will start directly after a device reset.</p> <p>"Connected sensor and ext. value via bus": This setting is used to combine the selected temperature sources. The external temperature is received by means of the "External value" 2-byte object.</p>	
Weighting of the measured values	10% to 90% 20% to 80% 30% to 70% 40% to 60% 50% to 50% 60% to 40% 70% to 30% 80% to 20% 90% to 10%
<p>The weighting of the measured temperature value of the connected sensor and the external sensor is defined here. That results in an overall value, which will be used for the further interpretation of the room temperature.</p> <p>This parameter is visible only if "Room temperature measurement by = connected sensor and ext. value via bus".</p>	

Connected sensor (0 = inactive)	-12.8...0...12.7
<p>Determines the value in Kelvin by which the measured value of the connected sensor is adjusted.</p> <p>This parameter is visible only if the temperature detection system requires a connected sensor.</p>	
External value via bus (0 = inactive)	-12.8...0...12.7
<p>Determines the value in Kelvin by which the external sensor's room temperature value is calibrated.</p> <p>This parameter is only visible when the temperature detection system requires an external sensor.</p>	
Transmit actual temperature	On change Cyclical On change and cyclical
<p>This parameter defines when the device transmits the actual temperature on the bus. According to the parameterisation, the ETS application program provides additional parameters.</p>	
On change by	0.1 ... 0.2 ... 25.5
<p>Determines the size of the value change of the room temperature in Kelvin after which the current value is automatically transmitted to the bus via the "Actual temperature" object.</p>	
Cycle time	0 ... 24 h, 0 ... 15 ... 60 min, 0 ... 60 s
<p>This parameter defines whether and when (in hours, minutes and seconds) the determined room temperature is to be periodically output via the "Actual temperature" object. The cycle time may be within a time frame of 3 seconds to 24 hours.</p>	
Actual temperature without calibration	Active Inactive
<p>If necessary, the unadjusted room temperature can be additionally transmitted to the bus as an information value via the object "Actual temperature without adjustment" and, for example, be displayed in visualisations. This parameter enables the corresponding object.</p> <p>i Besides the calibrated actual temperature, the additional object can be used advantageously for visualisation.</p>	

8.5.2 Object list

The following communication objects are available in the "temperature sensor" channel function. The name can be adjusted with the "Name" parameter.

Object no.	Function	Name	Type	DPT	Flag
941, 947	Temperature sensor - Actual temperature - Status	K n - Output	2-byte	9.001	C, R, -, T, A
<p>2-byte object for displaying the actual temperature (room temperature) determined internally. Possible range of values: -99.9 °C to +99.9 °C.</p> <p>The actual temperature is determined either by the connected sensor or by a combination of the connected sensor and an external value via the bus.</p> <p>i The output value does not take into account the parameterised values for the calibration.</p> <p>i The weighting of the measured values "connected sensor and ext. value via bus" is taken into account.</p> <p>The temperature value is always output in the format "°C".</p>					

Object no.	Function	Name	Type	DPT	Flag
942, 948	Temperature sensor - External value	K n - Input	2-byte	9.001	C, -, W, -, U
<p>2-byte object used to couple an external KNX room temperature sensor or a room temperature control point. Thus cascading of multiple temperature sensors for room temperature measurement. Possible range of values: -99.9 °C to +99.9 °C.</p> <p>The temperature value must always be specified in the format "°C".</p>					

Object no.	Function	Name	Type	DPT	Flag
944, 950	Temperature sensor - Actual temperature without calibration - Status	K n - Output	2-byte	9.001	C, R, -, T, A
<p>2-byte object for the display of the determined actual temperature. The actual temperature is either determined by the internal sensor or by a combination of the internal sensor with an external temperature.</p> <p>i The output value takes into account the parameterised values for the calibration.</p> <p>i The weighting of the measured values "connected sensor and ext. value via bus" is taken into account.</p> <p>The temperature value is always output in the format "°C".</p>					

8.6 Pulse counter

For each channel whose function is set to "pulse counter", the ETS indicates up to 16 communication objects. To an extent, the object data formats are dependent on the set pulse counter function.

In the function as a pulse meter, the device can count the number of pulses at the input of a channel.

As soon as a channel is set to the "pulse meter" function, this channel provides two pulse meters. The main meter and the intermediate meter are controlled equally by the pulses at the input channel, but count independently of each other. Both meters are configured independently of each other on separate parameter pages ("Main meter" and "Intermediate meter").

Synchronisation can be generated for load management. A synchronisation input is implemented by another input. Its output switch object can be linked to a group address on the "Meter query" input communication object, where it receives the synchronisation pulse.

- i** The prerequisite is that the parameter "Query meter reading via object" is activated.

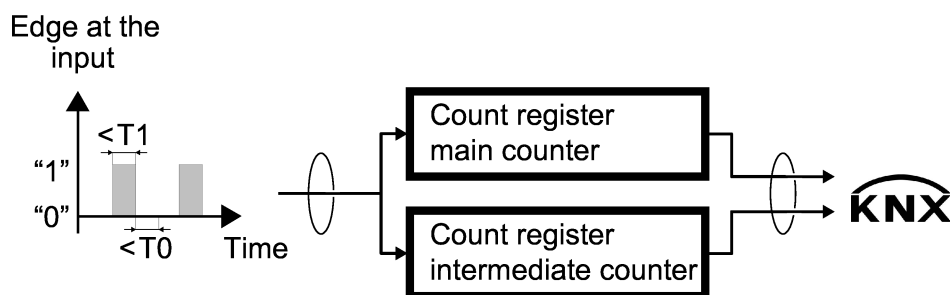

Figure 16: Pulse counter, functional diagram

- T0 Minimum signal duration for "0" signals
 T1 Minimum signal duration for "1" signals

Function of the pulse counter

The following basic settings for the functionality of the pulse meter are to be configured together for the main and intermediate meters on the parameter page "Kx - General". These basic settings cannot differentiate between the main and primary counters.

- Size and interval of the countable value range (parameter "Data point type | Value range")
- Signal evaluation in the device (parameter "Count pulses for")
- Ratio of the pulses output by the pulse generator to the pulses counted in the device ("Change meter reading per" parameter)
- Factor of the meter reading change per counted pulse ("Increment per meter reading change" parameter)

- Debouncing time and minimum signal duration
- Handling the meter reading after return of bus voltage or ETS download

Size and interval of the countable value range

For each channel whose function is set to "pulse counter", the ETS indicates up to 16 communication objects. Some of the data formats depend on the set data point type | value range of the pulse meter. The parameter "Data point type | Value range" defines the value range of the pulse meter to one of the following sizes and intervals:

- Pulse counter 0...255 (1-byte / KNX DPT 5.010)
- Pulse counter -128...127 (1-byte / KNX DPT 6.010)
- Pulse counter 0...65.535 (2-byte / KNX DPT 7.001)
- Pulse counter -32.768...32.767 (2-byte / KNX DPT 8.001)
- Pulse counter 0...4.294.967.295 (4-byte / KNX DPT 12.001)
- Pulse counter -2.147.483.647...2.147.483.647 (4-byte / KNX DPT 13.001)

The different data point types | value ranges of the pulse meter vary only in terms of the size and interval of the countable value range. The manner in which the pulses are counted is defined through the parameters in the ETS. For this purpose, the ETS provides different parameters that can adjust the function of the pulse meter individually, independently of the set data point type | value range of the pulse meter.

Signal evaluation in the device

The signal evaluation in the device is defined in the ETS. The device can recognise pulses by rising and/or falling edges. The "Count pulses for" parameter defines the edge that starts the signal evaluation in the device. The following settings in the ETS are possible:

- Rising edge
- Falling edge
- Rising and falling edge

Ratio of pulses emitted by the pulse generator to the pulses counted in the device

The "Change meter reading per" parameter defines the ratio of the pulses received at the input to the pulses counted in the device. The device works with a configurable debouncing time or minimum signal duration.

Example of setting the pulses at the input per counted pulse:
- "Data point type value range" = DPT 7.001 0...65535
- "Count pulses for" = rising edge
- "Change meter reading per" = 4 pulses
- "Increment per meter reading change" = 1

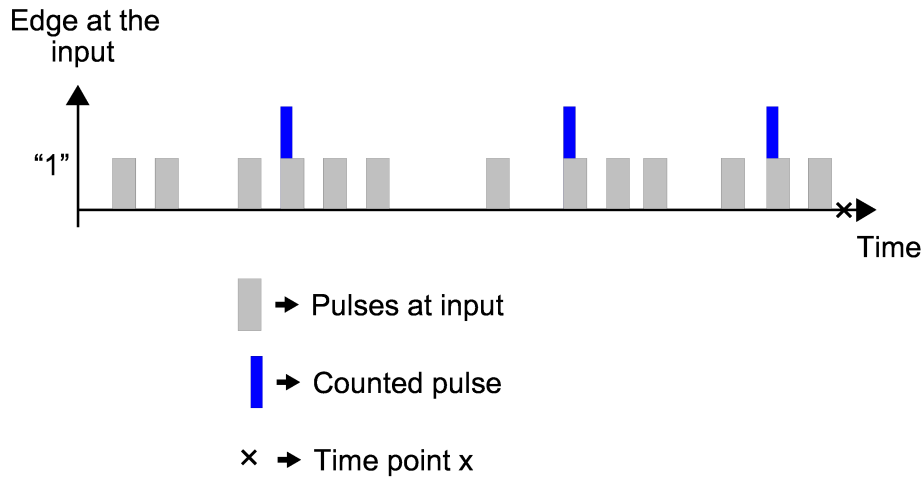

Figure 17: Example of setting the pulses at the input per counted pulse

The device internally counts the meter reading up for each counted pulse (up-counter) or down (down-counter). Thus, in this example the up-counter has a meter reading of 3. At time point x, the communication "... meter reading" would transmit a "3" on the bus at the time x.

Factor of the change in counter status per counted pulse

The "Change meter reading per" parameter defines the factor for the meter reading increase resulting from each counted pulse.

Example of setting the pulses at the input per counted pulse:
- "Data point type value range" = DPT 7.001 0...65535
- "Count pulses for" = rising edge
- "Change meter reading per" = 2 pulses
- "Increment per meter reading change" = 5

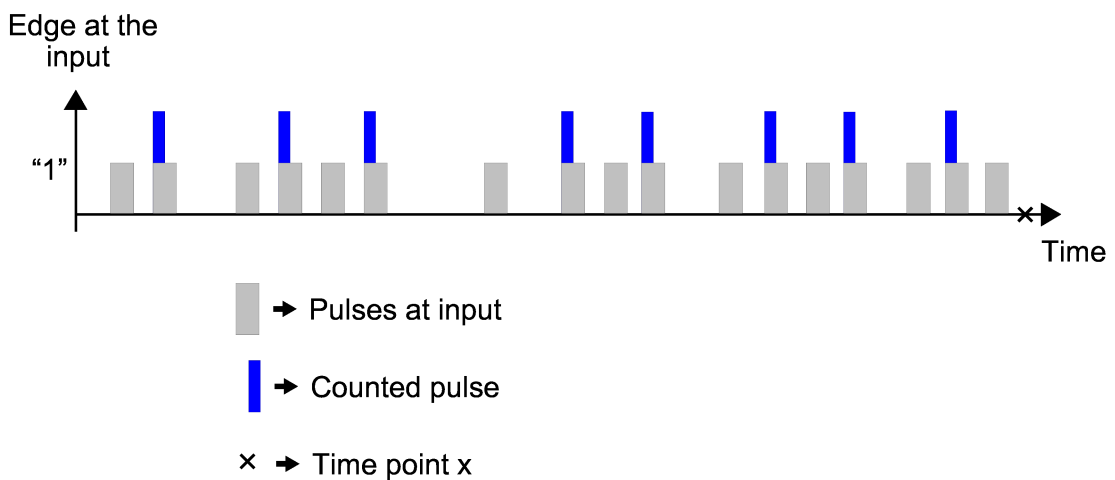

Figure 18: Example for setting the number of changes in counter status per counted pulse

The device internally counts the meter reading up for each counted pulse (up-counter) or down (down-counter). To determine the meter reading, the value of the configured "increment per meter reading change" is multiplied by the number of counted pulses. Thus, in this example an up meter would have a meter reading of "40". The "Change meter reading per" parameter defines the ratio of the pulses received at the input to the pulses counted in the device (17 pulses at the input -> 8 counted pulses). The communication object "... meter reading" sends a "40" to the KNX at time point x.

Debounce time or minimum signal duration

The parameter "Activate minimum signal duration" decides whether the input is to work with a definable time for the signal debouncing or a minimum signal duration for "0" or "1" signals with the configured pulse meter function.

If "Debounce time" is configured, the input immediately responds to an edge at the input. When the edge is detected at the input, a timer in the device begins to determine the time since the edge was detected. The input does not evaluate any pulses for the configured debounce duration.

If "Minimum signal duration" has been configured, when an edge is detected at the input, a timer in the device begins to determine the time since the detection. The input only evaluates the pulse after the configured minimum signal duration has elapsed. The signal must remain stable during the minimum signal duration.

The debounce time of the signal is defined by the device software via the parameter "Debounce time". When the pulse counter function is configured, the duration which must elapse between two pulses for a valid pulse of the connected contacts to be identified is defined for the input via the debounce time. In this way, it is possible to prevent the device from mistakenly identifying short conduction faults as a pulse. The debounce time makes it possible to adapt the signal evaluation to the contact quality of the connected pulse output also.

Increase the debounce time in the ETS if undesirable pulse evaluations with very fast edge changes resulting in rapidly changing telegram states occur regularly or sporadically.

With parameter "Minimum signal duration for ...", The times of the minimum signal duration for "0" and "1" signals is determined by the device software. When the pulse counter function is configured, the period during which a pulse must be present until a valid pulse is identified is defined for the input via the minimum signal duration. Different times can be defined for "0" and "1" signals here. In this way, it is possible to prevent the device from mistakenly identifying short conduction faults as a pulse.

Example of setting the minimum signal duration:
- "Data point type value range" = DPT 7.001 0...65535
- "Count pulses for" = rising edge
- "Change meter reading per" = 1 pulses
- "Increment per meter reading change" = 1

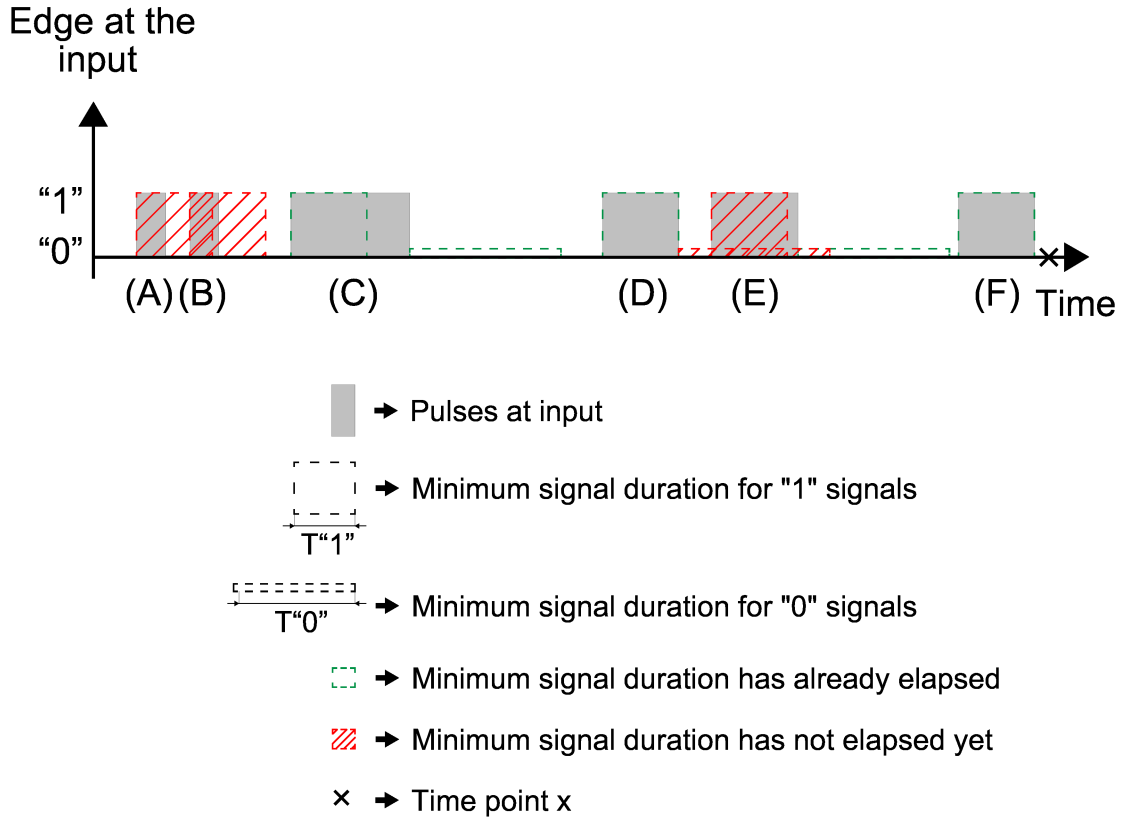

Figure 19: Example of setting the minimum signal duration

- (A) The duration of this pulse is shorter than the minimum signal duration defined for "1" signals. This pulse is not identified as a valid pulse by the device.
- (B) The duration of this pulse is shorter than the minimum signal duration defined for "1" signals. This pulse is not identified as a valid pulse by the device.
- (C) The duration of this pulse is longer than the minimum signal duration defined for "1" signals. This pulse is identified as a valid pulse by the device.
- (D) The duration of this pulse is equal to the minimum signal duration defined for "1" signals. The minimum signal duration for "0" signals has already elapsed. This pulse is identified as a valid pulse by the device.
- (E) The duration of this pulse is equal to the minimum signal duration defined for "1" signals. However, the minimum signal duration for "0" signals has not elapsed yet. This pulse is not identified as a valid pulse by the device.
- (F) The duration of this pulse is equal to the minimum signal duration defined for "1" signals. The minimum signal duration for "0" signals has already elapsed. This pulse is identified as a valid pulse by the device.

The device internally counts the meter reading up for each pulse (up-counter) or down (down-counter). To determine the counter status, the device evaluates the minimum signal duration set for the "0" and "1" signals. In this example, first the minimum signal duration for "0" signals must elapse after a valid pulse has been identi-

fied. Only then can the device recognise a "1" signal as a valid pulse again. Thus, in this example the up-counter has a meter reading of 3. At time point x, the communication "... meter reading" sends a "3" to the KNX at time point x.

Handling the meter reading after return of bus voltage or ETS download

The "Transmit after bus voltage return" and "Reset after ETS download" parameters define the behaviour of the device when dealing with the meter readings of the main and intermediate meters.

- i** The parameter settings are valid until the next time these parameters are adjusted in the ETS. The configured behaviour after bus voltage returns and after an ETS download is taken into account with each ETS download.

Main counter and intermediate counter

The following pulse meter settings are to be configured on the "Main meter" and "Intermediate meter" parameter pages. These settings are to be considered separately for the main and intermediate counters. The functions of the main and intermediate counters are identical except for a few parameter settings and so are described together here. The following parameters are different for the main and intermediate counters:

- "Behaviour after counter status polled via KNX"
- "Send meter reading"
- "Behaviour after counter has elapsed"

The counting direction can be separately defined for the main and intermediate counters in the ETS parameters. The meters function as either up- or down-counters. Regardless of counting direction, pulse counting begins at the start value and ends at the end value. The start and end values can be specified for the device via parameter or communication object. The value range in which the start/end values lie is based on the set "data point type | value range" of the pulse meter. When setting via parameter, the start and end values of the pulse counting are specified directly in the ETS. In this case, the preset default value is also oriented to the counter's counting direction. When setting via communication object, communication objects to specify the start and end values are enabled. The data format of the communication objects is oriented to the set function of the pulse counter.

- i** Condition (up-counter): Start value < End value

- i** Condition (down-counter): Start value > End value

The communication objects "... Start value" and "... End value" have the value "0" after a programming procedure. Therefore the greater than / less than condition is not satisfied. The meter has stopped and is in interval limit fault state. The interval limit fault is reported to the communication object of the same name on the KNX. As soon as the meter has received valid start and end values, the interval limit fault is cancelled and confirmed with a "0" telegram. The meter is ready for operation. Start and end values can be changed via the communication objects at any time. Para-

meter "Behaviour after meter has elapsed" defines the behaviour of the meter when the end value received via the communication object is greater or less than (depending on the counting direction) the current meter reading. If there is a power failure or a new programming procedure, the start and end values previously specified via communication object are saved within the device. Once the device restarts, these values are set as start and end values again. Whether the meter readings are transmitted after the bus voltage returns or are reset after a programming procedure is defined by the parameters on the parameter page "Kx - General" together for the main and intermediate meters.

- i** Start and end values specified via communication object also remain saved within the device after a discharge process.

The device can optionally transmit the current meter readings on the KNX in the event of "on change", "cyclical" or "on change and cyclical".

- i** A counter status change caused by a change of the start or end values does not result in transmission of the counter status. Transmission of the counter status after changes only occurs via the recognition of input pulses.

With the meter reading polling function, the device offers another possibility to send the counter status to the KNX. In this case, the device only transmits the meter reading if the counter status is polled via communication object. The "Query meter reading via object" parameter enables the corresponding communication object. This function can be used in parallel with the automatic transmission. The behaviour of the main counter after a counter status polling via KNX is permanently defined. The main counter continues to run after the counter status is polled. This is one aspect in which the main counter differs from the intermediate counter. The behaviour of the intermediate counter after a counter status polling via KNX can be defined with the same parameters. After a counter status polling, the intermediate counter can either continue to run or be reset and restarted. The device transmits the meter reading status before the meter reading is reset and the meter restarted.

- i** This behaviour is suitable, for example, for a bar chart display in a visualisation used to query the intermediate meter every hour.

When the specified end value is reached, the meter has elapsed. Optionally, an elapsed counter can be reported with a KNX telegram via the communication object "... Elapsed counter report". This communication object is enabled if the "Meter expiry status object" parameter is set to "Active".

Another function which is different between the main and intermediate counters is the behaviour after the counter elapses. The "Behaviour after meter expiry" parameter is permanently set to "Reset meter and restart" on the "Main meter" parameter page. On the "Intermediate meter" parameter page, this parameter decides whether the intermediate counter is to be reset and restarted or remain expired.

In the "Reset meter and restart" setting, the meter counts until the defined end value. Once this end value is reached, the meter reading is reset and the meter begins counting pulses from the defined start value again.

When "Intermediate counter stays elapsed" is set, the intermediate meter counts until the defined end value. Once this end value is reached, the intermediate counter stops counting. The intermediate meter must be reset before it can start counting pulses from the defined start value again. The corresponding communication object "... meter reset" is enabled by the parameter "Meter reset via object". This parameter is permanently set to "Active" in the "Meter stays elapsed" setting.

- i** In the same way, the configured "Behaviour after meter has elapsed" defines the behaviour of the meter if the end value received by the communication object is smaller or greater (depending on the counting direction) than the current meter reading.

The meter can be reset via KNX by means of the communication object "... meter reset" separately for the main and intermediate meter of each input if the "Meter reset via object" parameter is set to "Active". During a meter reset, the meter reading is reset to the start value and the meter is restarted. The function of the communication object "... meter reset" can be disabled, which allows an unintentional meter reset to be prevented. The communication object, which temporarily disables the possibility to reset the meter, is enabled when the parameter "Reset meter by disabling object" is set to "Active". During the disabled period (polarity of disabling object can be set), KNX telegrams to the communication object "... meter reset" are ignored and the meter cannot be reset. After the disabling is cancelled by a new KNX telegram with reversed polarity, the meter reading can again be reset.

Overview: Functions of the main and intermediate counters

One channel provides two pulse meters. The main meter and intermediate meter are controlled equally by the pulses at the channel, but count independently of each other. Both meters are configured independently of each other on separate parameter pages ("Main meter" and "Intermediate meter"). Project design of the main and intermediate counters is slightly different.

Function	Main counter	Intermediate meter
Can the data format of the counter be set?	Yes	Yes
Are counter statuses saved if there is a bus voltage failure?	Yes	Yes
Can start and end values can be specified in the parameters?	Yes	Yes
Can start and end values can be specified via communication objects?	Yes	Yes
Can the counting direction be set?	Yes	Yes
Can the meter reading be polled via a KNX communication object?	Yes	Yes
Can the behaviour of the counter after a counter status polling via KNX be set?	No	Yes
Can the meter reading be independently transmitted by the device?	Yes	Yes
Can the meter reading be reset automatically and the meter restarted after the status has been cyclically transmitted?	No	Yes

Function	Main counter	Intermediate meter
Can an elapsed counter be reported via a KNX telegram?	Yes	Yes
Can the behaviour of the counter after it has elapsed be defined?	No	Yes
Can the meter be reset and restarted with a KNX telegram?	Yes	Yes

8.6.1 Table of parameters

The following parameters are available in the "pulse meter" channel function on the "General" parameter page.

Data point type Value range	DPT 5.010 0...255 DPT 6.010 -128...127 DPT 7.001 0...65535 DPT 8.001 -32768...32767 DPT 12.001 0...4294967295 DPT 13.001 -2147483648...2147483647
This parameter defines the value range of the pulse meter. The size and interval of the counting range are set in dependence on this setting.	
Count pulses for	Rising edge Falling edge Rising and falling edge
The device can recognise pulses by rising and/or falling edges. This parameter specifies the edge which starts signal evaluation in the device.	
Change meter reading per	1 ... 10000 pulses
This parameter defines the ratio of pulses received at the input to the pulses counted in the device. The number of valid pulses specified here must be detected at the device input so the pulse counter can count a pulse.	
Increment per meter reading change	1 ... 10000
This parameter defines the factor for the meter reading change resulting from each counted pulse. The change in counter status is yielded by multiplying the factor entered here with the pulses counted by the pulse counter.	
Activate minimum signal duration	Active Inactive
This parameter decides whether the channel is to work with a definable time for the signal debouncing or a minimum signal duration for "0" or "1" signals with the configured pulse meter function. In the "active" setting, additional parameters that define the minimum signal duration for "0" and "1" signals become visible. In the "inactive" setting, the device works with a debouncing time in milliseconds defined by the parameter of the same name.	

For "0" signal	0 ... 59 min 0 ... 59 s 15 ... 100 ... 999 ms
<p>This parameter defines the time of the minimum signal duration for "0" signals. When the pulse counter function is configured, the period during which a pulse must be present until a valid pulse is identified is defined for the input via the minimum signal duration.</p> <p>A minimum signal duration of 0 min 0 s 15 ms to 59 min 59 s 999 ms can be set.</p>	

For "1" signal	0 ... 59 min 0 ... 59 s 15 ... 100 ... 999 ms
<p>This parameter defines the time of the minimum signal duration for "1" signals. When the pulse counter function is configured, the period during which a pulse must be present until a valid pulse is identified is defined for the input via the minimum signal duration.</p> <p>A minimum signal duration of 0 min 0 s 15 ms to 59 min 59 s 999 ms can be set.</p>	

Debounce time	4 ... 10 ... 255 ms
<p>This parameter defines the signal debouncing time by means of the device software. With the configured pulse meter function, the pulse duration after which a valid pulse of the connected contacts is identified is defined for the input by the debouncing time.</p>	

Transmit after bus voltage return	Active Inactive
<p>This parameter defines the behaviour of the device when handling the counter statuses of the main and intermediate counters. In the "active" setting, the current meter readings after the bus voltage returns are automatically transmitted on the KNX by means of the "Main meter reading" and "Intermediate meter reading" communication objects.</p>	

Reset after ETS download	Active Inactive
<p>This parameter defines the behaviour of the device when handling the counter statuses of the main and intermediate counters. In the "active" setting, the current meter readings are reset due to an ETS download.</p>	

The following parameters are available in the "pulse meter" channel function on the "Main meter" parameter page.

Counting direction	Forwards Backwards
<p>The meter functions as either an up- or down-counter. This parameter defines the counting direction. The counting range is determined by the functionality of the pulse meter and by the start and end values specified for the main meter.</p>	

Start value specification	Via parameter Via communication object
<p>Regardless of counting direction, pulse counting begins at the start value and ends at the end value. The start and end values can be specified for the device via parameter or communication object. Depending on this setting, the ETS provides either a parameter or a communication object for specifying the start value.</p> <p>The value range in which the start and end value lie is based on the set "data point type value range" of the pulse meter.</p> <p>i Condition (up meter): start value < end value condition (down meter): start value > end value</p>	

Start value	0 ... 254
<p>When setting via parameter, the start value of the pulse counting is specified directly with this parameter. In this case, the preset default value is also oriented to the counter's counting direction.</p> <p>This value range is available when the meter counts up.</p> <p>The start value can lie within this value range if "DPT 5.010 0...255" is set.</p>	

Start value	1 ... 255
<p>When setting via parameter, the start value of the pulse counting is specified directly with this parameter. In this case, the preset default value is also oriented to the counter's counting direction.</p> <p>This value range is available when the meter counts down.</p> <p>The start value can lie within this value range if "DPT 5.010 0...255" is set.</p>	

Start value	-128 ... 0 ... 126
<p>When setting via parameter, the start value of the pulse counting is specified directly with this parameter. In this case, the preset default value is also oriented to the counter's counting direction.</p> <p>This value range is available when the meter counts up.</p> <p>The start value can lie within this value range if "DPT 6.010 -128...127" is set.</p>	

Start value	-127 ... 127
<p>When setting via parameter, the start value of the pulse counting is specified directly with this parameter. In this case, the preset default value is also oriented to the counter's counting direction.</p> <p>This value range is available when the meter counts down.</p> <p>The start value can lie within this value range if "DPT 6.010 -128...127" is set.</p>	

Start value	0 ... 65534
<p>When setting via parameter, the start value of the pulse counting is specified directly with this parameter. In this case, the preset default value is also oriented to the counter's counting direction.</p> <p>This value range is available when the meter counts up.</p> <p>The start value can lie within this value range if "DPT 7.001 0...65535" is set.</p>	
Start value	1 ... 65535
<p>When setting via parameter, the start value of the pulse counting is specified directly with this parameter. In this case, the preset default value is also oriented to the counter's counting direction.</p> <p>This value range is available when the meter counts down.</p> <p>The start value can lie within this value range if "DPT 7.001 0...65535" is set.</p>	
Start value	-32768 ... 0 ... 32766
<p>When setting via parameter, the start value of the pulse counting is specified directly with this parameter. In this case, the preset default value is also oriented to the counter's counting direction.</p> <p>This value range is available when the meter counts up.</p> <p>The start value can lie within this value range if "DPT 8.001 -32768...32767" is set.</p>	
Start value	-32767 ... 32767
<p>When setting via parameter, the start value of the pulse counting is specified directly with this parameter. In this case, the preset default value is also oriented to the counter's counting direction.</p> <p>This value range is available when the meter counts down.</p> <p>The start value can lie within this value range if "DPT 8.001 -32768...32767" is set.</p>	
Start value	0 ... 4294967294
<p>When setting via parameter, the start value of the pulse counting is specified directly with this parameter. In this case, the preset default value is also oriented to the counter's counting direction.</p> <p>This value range is available when the meter counts up.</p> <p>The start value can lie within this value range if "DPT 12.001 0...4294967295" is set.</p>	
Start value	1 ... 4294967295
<p>When setting via parameter, the start value of the pulse counting is specified directly with this parameter. In this case, the preset default value is also oriented to the counter's counting direction.</p> <p>This value range is available when the meter counts down.</p> <p>The start value can lie within this value range if "DPT 12.001 0...4294967295" is set.</p>	

Start value	-2147483648 ... 0 ... 2147483646
<p>When setting via parameter, the start value of the pulse counting is specified directly with this parameter. In this case, the preset default value is also oriented to the counter's counting direction.</p> <p>This value range is available when the meter counts up.</p> <p>The start value can lie within this value range if "DPT 13.001 -2147483648...2147483647" is set.</p>	

Start value	-2147483647 ... 2147483647
<p>When setting via parameter, the start value of the pulse counting is specified directly with this parameter. In this case, the preset default value is also oriented to the counter's counting direction.</p> <p>This value range is available when the meter counts down.</p> <p>The start value can lie within this value range if "DPT 13.001 -2147483648...2147483647" is set.</p>	

End value specification	<p>Via parameter</p> <p>Via communication object</p>
<p>Regardless of counting direction, pulse counting begins at the start value and ends at the end value. The start and end values can be specified for the device via parameter or communication object. Depending on this setting, the ETS provides either a parameter or a communication object for specifying the end value.</p> <p>The value range in which the start and end value lie is based on the set "data point type value range" of the pulse meter.</p> <p>i Condition (up meter): start value < end value condition (down meter): start value > end value</p>	

End value	1 ... 255
<p>When setting via parameter, the end value of the pulse counting is specified directly with this parameter. In this case, the preset default value is also oriented to the counter's counting direction.</p> <p>This value range is available when the meter counts up.</p> <p>The end value can lie within this value range if "DPT 5.010 0...255" is set.</p>	

End value	0 ... 254
<p>When setting via parameter, the end value of the pulse counting is specified directly with this parameter. In this case, the preset default value is also oriented to the counter's counting direction.</p> <p>This value range is available when the meter counts down.</p> <p>The end value can lie within this value range if "DPT 5.010 0...255" is set.</p>	

End value	-127 ... 127
<p>When setting via parameter, the end value of the pulse counting is specified directly with this parameter. In this case, the preset default value is also oriented to the counter's counting direction.</p> <p>This value range is available when the meter counts up.</p> <p>The end value can lie within this value range if "DPT 6.010 -128...127" is set.</p>	
End value	-128 ... 0 ... 126
<p>When setting via parameter, the end value of the pulse counting is specified directly with this parameter. In this case, the preset default value is also oriented to the counter's counting direction.</p> <p>This value range is available when the meter counts down.</p> <p>The end value can lie within this value range if "DPT 6.010 -128...127" is set.</p>	
End value	1 ... 65535
<p>When setting via parameter, the end value of the pulse counting is specified directly with this parameter. In this case, the preset default value is also oriented to the counter's counting direction.</p> <p>This value range is available when the meter counts up.</p> <p>The end value can lie within this value range if "DPT 7.001 0...65535" is set.</p>	
End value	0 ... 65534
<p>When setting via parameter, the end value of the pulse counting is specified directly with this parameter. In this case, the preset default value is also oriented to the counter's counting direction.</p> <p>This value range is available when the meter counts down.</p> <p>The end value can lie within this value range if "DPT 7.001 0...65535" is set.</p>	
End value	-32767 ... 32767
<p>When setting via parameter, the end value of the pulse counting is specified directly with this parameter. In this case, the preset default value is also oriented to the counter's counting direction.</p> <p>This value range is available when the meter counts up.</p> <p>The end value can lie within this value range if "DPT 8.001 -32768...32767" is set.</p>	
End value	-32768 ... 0 ... 32766
<p>When setting via parameter, the end value of the pulse counting is specified directly with this parameter. In this case, the preset default value is also oriented to the counter's counting direction.</p> <p>This value range is available when the meter counts down.</p> <p>The end value can lie within this value range if "DPT 8.001 -32768...32767" is set.</p>	

End value	1 ... 4294967295
<p>When setting via parameter, the end value of the pulse counting is specified directly with this parameter. In this case, the preset default value is also oriented to the counter's counting direction.</p> <p>This value range is available when the meter counts up.</p> <p>The end value can lie within this value range if "DPT 12.001 0...4294967295" is set.</p>	
End value	0 ... 4294967294
<p>When setting via parameter, the end value of the pulse counting is specified directly with this parameter. In this case, the preset default value is also oriented to the counter's counting direction.</p> <p>This value range is available when the meter counts down.</p> <p>The end value can lie within this value range if "DPT 12.001 0...4294967295" is set.</p>	
End value	-2147483647 ... 2147483647
<p>When setting via parameter, the end value of the pulse counting is specified directly with this parameter. In this case, the preset default value is also oriented to the counter's counting direction.</p> <p>This value range is available when the meter counts up.</p> <p>The end value can lie within this value range if "DPT 13.001 -2147483648...2147483647" is set.</p>	
End value	-2147483648 ... 0 ... 2147483646
<p>When setting via parameter, the end value of the pulse counting is specified directly with this parameter. In this case, the preset default value is also oriented to the counter's counting direction.</p> <p>This value range is available when the meter counts down.</p> <p>The end value can lie within this value range if "DPT 13.001 -2147483648...2147483647" is set.</p>	
Query meter reading via object	Active Inactive
<p>With the meter reading polling function, the device offers another possibility to send the counter status to the KNX. In this case, the device only transmits the meter reading if the counter status is polled via communication object. This parameter enables the corresponding communication object. This function can be used in parallel with the automatic transmission.</p>	
Behaviour after meter expiry	Reset meter and restart
<p>This parameter is permanently set to "Reset meter and restart". Correspondingly, the main counter is reset and restarted after the counter has elapsed. In the same way, the configured "Behaviour after meter has elapsed" defines the behaviour of the meter when the end value received via the communication object is greater or less than (depending on the counting direction) the current meter reading.</p>	

"Meter expiry" status object	Active Inactive
Optionally, the expiry of a meter can be reported with a KNX telegram by means of the "meter expiry" communication object. This communication object becomes available when this parameter is set to "active".	
Meter reset via object	Active Inactive
The meter reset via KNX can be set separately by means of the "meter reset" communication object for the main and intermediate meter of each input if this parameter is set to "active". When a meter is reset, the meter reading is reset to the start value and restarted.	
Reset meter by disabling object	Active Inactive
The function of the "meter reset" communication object can be disabled. The communication object, which temporarily disables the possibility to reset a meter, is enabled if this parameter is set to "active".	
Object polarity	1 = disable / 0 = enable 0 = disable / 1 = enable
The polarity of the disabling object for the meter reset can be set with this parameter.	
Send meter reading	On change Cyclical On change and cyclical
This parameter defines the criterion for automatic transmission of the counter status. Additional parameters are displayed depending on this setting.	
On change by	1 ... 100 ... 65535 (255, 127, 32767, ...)
If the meter reading is to be transmitted after changing, this parameter defines the exact value by which the meter reading needs to have changed for the device to transmit the current meter reading again. The value range of this parameter is based on the set "data point type value range" of the pulse meter. This parameter is visible when the meter reading is sent "For change" or "For change and cyclical".	
Cycle time	0 ... 24 h 0 ... 5 ... 59 min 0 ... 10 ... 59 s
The device always transmits the meter reading cyclically after the time defined in the parameters has elapsed. The sum resulting from the parameters for minutes, seconds and milliseconds yields the total cycle time. This parameter is visible when the meter reading is sent "Cyclically" or "For change and cyclically". A cycle time of 3 s to 24 h can be set.	

The following parameters are available in the "Pulse meter" channel function on the "Intermediate meter" parameter page.

Counting direction	Forwards Backwards
The meter functions as either an up- or down-counter. This parameter defines the counting direction. The counting range is determined by the functionality of the pulse meter and the start and end values specified for the intermediate meter.	
Start value specification	Via parameter Via communication object
Regardless of counting direction, pulse counting begins at the start value and ends at the end value. The start and end values can be specified for the device via parameter or communication object. Depending on this setting, the ETS provides either a parameter or a communication object for specifying the start value. The value range in which the start and end value lie is based on the set "data point type value range" of the pulse meter.	
<p>i Condition (up meter): start value < end value condition (down meter): start value > end value</p>	
Start value	0 ... 254
When setting via parameter, the start value of the pulse counting is specified directly with this parameter. In this case, the preset default value is also oriented to the counter's counting direction. This value range is available when the meter counts up. The start value can lie within this value range if "DPT 5.010 0...255" is set.	
Start value	1 ... 255
When setting via parameter, the start value of the pulse counting is specified directly with this parameter. In this case, the preset default value is also oriented to the counter's counting direction. This value range is available when the meter counts down. The start value can lie within this value range if "DPT 5.010 0...255" is set.	
Start value	-128 ... 0 ... 126
When setting via parameter, the start value of the pulse counting is specified directly with this parameter. In this case, the preset default value is also oriented to the counter's counting direction. This value range is available when the meter counts up. The start value can lie within this value range if "DPT 6.010 -128...127" is set.	

Start value	-127 ... 127
<p>When setting via parameter, the start value of the pulse counting is specified directly with this parameter. In this case, the preset default value is also oriented to the counter's counting direction.</p> <p>This value range is available when the meter counts down.</p> <p>The start value can lie within this value range if "DPT 6.010 -128...127" is set.</p>	
Start value	0 ... 65534
<p>When setting via parameter, the start value of the pulse counting is specified directly with this parameter. In this case, the preset default value is also oriented to the counter's counting direction.</p> <p>This value range is available when the meter counts up.</p> <p>The start value can lie within this value range if "DPT 7.001 0...65535" is set.</p>	
Start value	1 ... 65535
<p>When setting via parameter, the start value of the pulse counting is specified directly with this parameter. In this case, the preset default value is also oriented to the counter's counting direction.</p> <p>This value range is available when the meter counts down.</p> <p>The start value can lie within this value range if "DPT 7.001 0...65535" is set.</p>	
Start value	-32768 ... 0 ... 32766
<p>When setting via parameter, the start value of the pulse counting is specified directly with this parameter. In this case, the preset default value is also oriented to the counter's counting direction.</p> <p>This value range is available when the meter counts up.</p> <p>The start value can lie within this value range if "DPT 8.001 -32768...32767" is set.</p>	
Start value	-32767 ... 32767
<p>When setting via parameter, the start value of the pulse counting is specified directly with this parameter. In this case, the preset default value is also oriented to the counter's counting direction.</p> <p>This value range is available when the meter counts down.</p> <p>The start value can lie within this value range if "DPT 8.001 -32768...32767" is set.</p>	
Start value	0 ... 4294967294
<p>When setting via parameter, the start value of the pulse counting is specified directly with this parameter. In this case, the preset default value is also oriented to the counter's counting direction.</p> <p>This value range is available when the meter counts up.</p> <p>The start value can lie within this value range if "DPT 12.001 0...4294967295" is set.</p>	

Start value	1 ... 4294967295
<p>When setting via parameter, the start value of the pulse counting is specified directly with this parameter. In this case, the preset default value is also oriented to the counter's counting direction.</p> <p>This value range is available when the meter counts down.</p> <p>The start value can lie within this value range if "DPT 12.001 0...4294967295" is set.</p>	

Start value	-2147483648 ... 0 ... 2147483646
<p>When setting via parameter, the start value of the pulse counting is specified directly with this parameter. In this case, the preset default value is also oriented to the counter's counting direction.</p> <p>This value range is available when the meter counts up.</p> <p>The start value can lie within this value range if "DPT 13.001 -2147483648...2147483647" is set.</p>	

Start value	-2147483647 ... 2147483647
<p>When setting via parameter, the start value of the pulse counting is specified directly with this parameter. In this case, the preset default value is also oriented to the counter's counting direction.</p> <p>This value range is available when the meter counts down.</p> <p>The start value can lie within this value range if "DPT 13.001 -2147483648...2147483647" is set.</p>	

End value specification	<p>Via parameter</p> <p>Via communication object</p>
<p>Regardless of counting direction, pulse counting begins at the start value and ends at the end value. The start and end values can be specified for the device via parameter or communication object. Depending on this setting, the ETS provides either a parameter or a communication object for specifying the end value.</p> <p>The value range in which the start and end value lie is based on the set "data point type value range" of the pulse meter.</p> <p>i Condition (up meter): start value < end value condition (down meter): start value > end value</p>	

End value	1 ... 255
<p>When setting via parameter, the end value of the pulse counting is specified directly with this parameter. In this case, the preset default value is also oriented to the counter's counting direction.</p> <p>This value range is available when the meter counts up.</p> <p>The end value can lie within this value range if "DPT 5.010 0...255" is set.</p>	

End value	0 ... 254
<p>When setting via parameter, the end value of the pulse counting is specified directly with this parameter. In this case, the preset default value is also oriented to the counter's counting direction.</p> <p>This value range is available when the meter counts down.</p> <p>The end value can lie within this value range if "DPT 5.010 0...255" is set.</p>	
End value	-127 ... 127
<p>When setting via parameter, the end value of the pulse counting is specified directly with this parameter. In this case, the preset default value is also oriented to the counter's counting direction.</p> <p>This value range is available when the meter counts up.</p> <p>The end value can lie within this value range if "DPT 6.010 -128...127" is set.</p>	
End value	-128 ... 0 ... 126
<p>When setting via parameter, the end value of the pulse counting is specified directly with this parameter. In this case, the preset default value is also oriented to the counter's counting direction.</p> <p>This value range is available when the meter counts down.</p> <p>The end value can lie within this value range if "DPT 6.010 -128...127" is set.</p>	
End value	1 ... 65535
<p>When setting via parameter, the end value of the pulse counting is specified directly with this parameter. In this case, the preset default value is also oriented to the counter's counting direction.</p> <p>This value range is available when the meter counts up.</p> <p>The end value can lie within this value range if "DPT 7.001 0...65535" is set.</p>	
End value	0 ... 65534
<p>When setting via parameter, the end value of the pulse counting is specified directly with this parameter. In this case, the preset default value is also oriented to the counter's counting direction.</p> <p>This value range is available when the meter counts down.</p> <p>The end value can lie within this value range if "DPT 7.001 0...65535" is set.</p>	
End value	-32767 ... 32767
<p>When setting via parameter, the end value of the pulse counting is specified directly with this parameter. In this case, the preset default value is also oriented to the counter's counting direction.</p> <p>This value range is available when the meter counts up.</p> <p>The end value can lie within this value range if "DPT 8.001 -32768...32767" is set.</p>	

End value	-32768 ... 0 ... 32766
<p>When setting via parameter, the end value of the pulse counting is specified directly with this parameter. In this case, the preset default value is also oriented to the counter's counting direction.</p> <p>This value range is available when the meter counts down.</p> <p>The end value can lie within this value range if "DPT 8.001 -32768...32767" is set.</p>	
End value	1 ... 4294967295
<p>When setting via parameter, the end value of the pulse counting is specified directly with this parameter. In this case, the preset default value is also oriented to the counter's counting direction.</p> <p>This value range is available when the meter counts up.</p> <p>The end value can lie within this value range if "DPT 12.001 0...4294967295" is set.</p>	
End value	0 ... 4294967294
<p>When setting via parameter, the end value of the pulse counting is specified directly with this parameter. In this case, the preset default value is also oriented to the counter's counting direction.</p> <p>This value range is available when the meter counts down.</p> <p>The end value can lie within this value range if "DPT 12.001 0...4294967295" is set.</p>	
End value	-2147483647 ... 2147483647
<p>When setting via parameter, the end value of the pulse counting is specified directly with this parameter. In this case, the preset default value is also oriented to the counter's counting direction.</p> <p>This value range is available when the meter counts up.</p> <p>The end value can lie within this value range if "DPT 13.001 -2147483648...2147483647" is set.</p>	
End value	-2147483648 ... 0 ... 2147483646
<p>When setting via parameter, the end value of the pulse counting is specified directly with this parameter. In this case, the preset default value is also oriented to the counter's counting direction.</p> <p>This value range is available when the meter counts down.</p> <p>The end value can lie within this value range if "DPT 13.001 -2147483648...2147483647" is set.</p>	
Query meter reading via object	Active Inactive
<p>With the meter reading polling function, the device offers another possibility to send the counter status to the KNX. In this case, the device only transmits the meter reading if the counter status is polled via communication object. This parameter enables the corresponding communication object. This function can be used in parallel with the automatic transmission.</p>	

Behaviour	Meter continues to run Reset meter and restart
The behaviour of the intermediate meter after querying a meter reading by means of an object can be defined. After a counter status polling, the intermediate counter can either continue to run or be reset and restarted. The device transmits the meter reading status before the meter reading is reset and the meter restarted.	
Behaviour after meter expiry	Meter remains elapsed (reset required) Reset meter and restart
This parameter defines whether the intermediate counter is reset and restarted after it elapses or if it stays elapsed. In the "Reset meter and restart" setting, the meter counts until the defined end value is reached. Once this end value is reached, the meter reading is reset and the meter begins counting pulses from the defined start value again. In the "Meter remains elapsed (reset required)" setting, the intermediate meter counts until the defined end value is reached. Once this end value is reached, the intermediate counter stops counting. The intermediate meter must be reset before it can start counting pulses from the defined start value again. The "Meter reset via object" parameter is permanently set to "active" in the "Meter stays elapsed" setting. In the same way, the configured "Behaviour after meter has elapsed" defines the behaviour of the meter if the end value received by the communication object is smaller or greater than (depending on the counting direction) the current meter reading.	
"Meter expiry" status object	Active Inactive
Optionally, the expiry of a meter can be reported with a KNX telegram by means of the "meter expiry" communication object. This communication object becomes available when this parameter is set to "active".	
Meter reset via object	Active Inactive
The meter reset via KNX can be set separately by means of the "meter reset" communication object for the main and intermediate meter of each input if this parameter is set to "active". When a meter is reset, the meter reading is reset to the start value and restarted.	
Reset meter by disabling object	Active Inactive
The function of the "meter reset" communication object can be disabled. The communication object, which temporarily disables the possibility to reset a meter, is enabled if this parameter is set to "active".	

Object polarity	1 = disable / 0 = enable 0 = disable / 1 = enable
The polarity of the disabling object for the meter reset can be set with this parameter.	
Send meter reading	On change Cyclical On change and cyclical
This parameter defines the criterion for automatic transmission of the counter status. Additional parameters are displayed depending on this setting.	
On change by	1 ... 100 ... 65535 (255, 127, 32767, ...)
If the meter reading is to be transmitted after changing, this parameter defines the exact value by which the meter reading needs to have changed for the device to transmit the current meter reading again. The value range of this parameter is based on the set "data point type value range" of the pulse meter. This parameter is visible when the meter reading is sent "For change" or "For change and cyclical".	
Cycle time	0 ... 24 h 0 ... 5 ... 59 min 0 ... 10 ... 59 s
The device always transmits the meter reading cyclically after the time defined in the parameters has elapsed. The sum resulting from the parameters for minutes, seconds and milliseconds yields the total cycle time. This parameter is visible when the meter reading is sent "Cyclically" or "For change and cyclically". A cycle time of 3 s to 24 h can be set.	

8.6.2 Object list

The following communication objects are available for the main meter in the "pulse meter" channel function. The name can be adjusted with the "Name" parameter.

Object no.	Function	Name	Type	DPT	Flag
781, 801, ..., 921	Pulse meter - Main meter - Meter run - Status	K <i>n</i> - Output	1-bit	1.002	C, R, -, T, A

This 1-bit object reports that the main counter has elapsed to the KNX. Visible only if the "Meter expiry status object" parameter is set to "active".

Object no.	Function	Name	Type	DPT	Flag
782, 802, ..., 922	Pulse meter - Main meter - Interval limit error - Status	K <i>n</i> - Output	1-bit	1.002	C, R, -, T, A

This 1-bit object reports a main counter interval limit fault to the KNX.

An interval limit error is transmitted if: - Up meter: start value \geq end value, - Down meter: start value \leq end value.

The interval limit fault is also read out if the communication objects "start value" and "end value" have not yet received a valid value telegram via the KNX.

Object no.	Function	Name	Type	DPT	Flag
783, 803, ..., 923	Pulse meter - Main meter - Meter reading - Query	K <i>n</i> - Input	1-bit	1.017	C, -, W, -, U

1-bit object for polling the current main counter status. If this object is defined with a "1" telegram, the device transmits the current meter reading to the KNX.

This communication object is visible only if the "Query meter reading via object" parameter is set to "active".

Object no.	Function	Name	Type	DPT	Flag
784, 804, ..., 924	Pulse meter - Main meter - Meter reset	K <i>n</i> - Input	1-bit	1.015	C, -, W, -, U

1-bit object for resetting the current main counter status.

If this object is defined with a "1" telegram, the meter reading is reset to the start value that was configured or specified via an object.

This communication object is visible only if the "Meter reset via object" parameter is set to "active".

Object no.	Function	Name	Type	DPT	Flag
785, 805, ..., 925	Pulse meter - Main meter - Meter read- ing - Status	K n - Output	1-byte	5.010	C, R, -, T, A

This 1-bit object automatically transmits the current meter reading of the main meter on the KNX (after a change or cyclically).

The meter reading can be read out via the KNX if the R-flag is set. The data format and data point type are set according to the configured "data point type | value range" of the pulse meter (here: pulse meter 0...255).

Object no.	Function	Name	Type	DPT	Flag
785, 805, ..., 925	Pulse meter - Main meter - Meter read- ing - Status	K n - Output	1-byte	6.010	C, R, -, T, A

This 1-bit object automatically transmits the current meter reading of the main meter on the KNX (after a change or cyclically).

The meter reading can be read out via the KNX if the R-flag is set. The data format and data point type are set according to the configured "data point type | value range" of the pulse meter (here: pulse meter -128...127).

Object no.	Function	Name	Type	DPT	Flag
785, 805, ..., 925	Pulse meter - Main meter - Meter read- ing - Status	K n - Output	2-byte	7.001	C, R, -, T, A

This 2-bit object automatically transmits the current meter reading of the main meter on the KNX (after a change or cyclically).

The meter reading can be read out via the KNX if the R-flag is set. The data format and data point type are set according to the configured "data point type | value range" of the pulse meter (here: pulse meter 0...65535).

Object no.	Function	Name	Type	DPT	Flag
785, 805, ..., 925	Pulse meter - Main meter - Meter read- ing - Status	K n - Output	2-byte	8.001	C, R, -, T, A

This 2-bit object automatically transmits the current meter reading of the main meter on the KNX (after a change or cyclically).

The meter reading can be read out via the KNX if the R-flag is set. The data format and data point type are set according to the configured "data point type | value range" of the pulse meter (here: pulse meter -32768...32767).

Object no.	Function	Name	Type	DPT	Flag
785, 805, ..., 925	Pulse meter - Main meter - Meter read- ing - Status	K <i>n</i> - Output	4-byte	12.001	C, R, -, T, A

This 4-bit object automatically transmits the current meter reading of the main meter on the KNX (after a change or cyclically).

The meter reading can be read out via the KNX if the R-flag is set. The data format and data point type are set according to the configured "data point type | value range" of the pulse meter (here: pulse meter 0...4294967295).

Object no.	Function	Name	Type	DPT	Flag
785, 805, ..., 925	Pulse meter - Main meter - Meter read- ing - Status	K <i>n</i> - Output	4-byte	13.001	C, R, -, T, A

This 4-bit object automatically transmits the current meter reading of the main meter on the KNX (after a change or cyclically).

The meter reading can be read out via the KNX if the R-flag is set. The data format and data point type are set according to the configured "data point type | value range" of the pulse meter (here: pulse meter -2147483648...2147483647).

Object no.	Function	Name	Type	DPT	Flag
786, 806, ..., 926	Pulse meter - Main meter - Start value	K <i>n</i> - Input	1-byte	5.010	C, -, W, -, U

If the main counter is working as an up-counter, the input receives the start value of the main counter via this communication object. This object is visible if the "Start value specification" parameter is set to "Via communication object".

As long as no correct value telegram is received, the input transmits an interval limit fault. The data format and data point type are set according to the configured "data point type | value range" of the pulse meter (here: pulse meter 0...255).

Object no.	Function	Name	Type	DPT	Flag
786, 806, ..., 926	Pulse meter - Main meter - Start value	K <i>n</i> - Input	1-byte	6.010	C, -, W, -, U

If the main counter is working as an up-counter, the input receives the start value of the main counter via this communication object. This object is visible if the "Start value specification" parameter is set to "Via communication object".

As long as no correct value telegram is received, the input transmits an interval limit fault. The data format and data point type are set according to the configured "data point type | value range" of the pulse meter (here: pulse meter -128...127).

Object no.	Function	Name	Type	DPT	Flag
786, 806, ..., 926	Pulse meter - Main meter - Start value	K <i>n</i> - Input	2-byte	7.001	C, -, W, -, U

If the main counter is working as an up-counter, the input receives the start value of the main counter via this communication object. This object is visible if the "Start value specification" parameter is set to "Via communication object".

As long as no correct value telegram is received, the input transmits an interval limit fault. The data format and data point type are set according to the configured "data point type | value range" of the pulse meter (here: pulse meter 0...65535).

Object no.	Function	Name	Type	DPT	Flag
786, 806, ..., 926	Pulse meter - Main meter - Start value	K <i>n</i> - Input	2-byte	8.001	C, -, W, -, U

If the main counter is working as an up-counter, the input receives the start value of the main counter via this communication object. This object is visible if the "Start value specification" parameter is set to "Via communication object".

As long as no correct value telegram is received, the input transmits an interval limit fault. The data format and data point type are set according to the configured "data point type | value range" of the pulse meter (here: pulse meter -32768...32767).

Object no.	Function	Name	Type	DPT	Flag
786, 806, ..., 926	Pulse meter - Main meter - Start value	K <i>n</i> - Input	4-byte	12.001	C, -, W, -, U

If the main counter is working as an up-counter, the input receives the start value of the main counter via this communication object. This object is visible if the "Start value specification" parameter is set to "Via communication object".

As long as no correct value telegram is received, the input transmits an interval limit fault. The data format and data point type are set according to the configured "data point type | value range" of the pulse meter (here: pulse meter 0...4294967295).

Object no.	Function	Name	Type	DPT	Flag
786, 806, ..., 926	Pulse meter - Main meter - Start value	K <i>n</i> - Input	4-byte	13.001	C, -, W, -, U

If the main counter is working as an up-counter, the input receives the start value of the main counter via this communication object. This object is visible if the "Start value specification" parameter is set to "Via communication object".

As long as no correct value telegram is received, the input transmits an interval limit fault. The data format and data point type are set according to the configured "data point type | value range" of the pulse meter (here: pulse meter -2147483648...2147483647).

Object no.	Function	Name	Type	DPT	Flag
787, 807, ..., 927	Pulse meter - Main meter - End value	K <i>n</i> - Input	1-byte	5.010	C, -, W, -, U

If the main counter is working as an up-counter, the input receives the end value of the main counter via this communication object. This object is visible when parameter "End value specification" is set to "Via communication object".

As long as no correct value telegram is received, the input transmits an interval limit fault. The data format and data point type are set according to the configured "data point type | value range" of the pulse meter (here: pulse meter 0...255).

Object no.	Function	Name	Type	DPT	Flag
787, 807, ..., 927	Pulse meter - Main meter - End value	K <i>n</i> - Input	1-byte	6.010	C, -, W, -, U

If the main counter is working as an up-counter, the input receives the end value of the main counter via this communication object. This object is visible when parameter "End value specification" is set to "Via communication object".

As long as no correct value telegram is received, the input transmits an interval limit fault. The data format and data point type are set according to the configured "data point type | value range" of the pulse meter (here: pulse meter -128...127).

Object no.	Function	Name	Type	DPT	Flag
787, 807, ..., 927	Pulse meter - Main meter - End value	K <i>n</i> - Input	2-byte	7.001	C, -, W, -, U

If the main counter is working as an up-counter, the input receives the end value of the main counter via this communication object. This object is visible when parameter "End value specification" is set to "Via communication object".

As long as no correct value telegram is received, the input transmits an interval limit fault. The data format and data point type are set according to the configured "data point type | value range" of the pulse meter (here: pulse meter 0...65535).

Object no.	Function	Name	Type	DPT	Flag
787, 807, ..., 927	Pulse meter - Main meter - End value	K <i>n</i> - Input	2-byte	8.001	C, -, W, -, U

If the main counter is working as an up-counter, the input receives the end value of the main counter via this communication object. This object is visible when parameter "End value specification" is set to "Via communication object".

As long as no correct value telegram is received, the input transmits an interval limit fault. The data format and data point type are set according to the configured "data point type | value range" of the pulse meter (here: pulse meter -32768...32767).

Object no.	Function	Name	Type	DPT	Flag
787, 807, ..., 927	Pulse meter - Main meter - End value	K n - Input	4-byte	12.001	C, -, W, -, U

If the main counter is working as an up-counter, the input receives the end value of the main counter via this communication object. This object is visible when parameter "End value specification" is set to "Via communication object".

As long as no correct value telegram is received, the input transmits an interval limit fault. The data format and data point type are set according to the configured "data point type | value range" of the pulse meter (here: pulse meter 0...4294967295).

Object no.	Function	Name	Type	DPT	Flag
787, 807, ..., 927	Pulse meter - Main meter - End value	K n - Input	4-byte	13.001	C, -, W, -, U

If the main counter is working as an up-counter, the input receives the end value of the main counter via this communication object. This object is visible when parameter "End value specification" is set to "Via communication object".

As long as no correct value telegram is received, the input transmits an interval limit fault. The data format and data point type are set according to the configured "data point type | value range" of the pulse meter (here: pulse meter -2147483648...2147483647).

Object no.	Function	Name	Type	DPT	Flag
786, 806, ..., 926	Pulse meter - Main meter - End value	K n - Input	1-byte	5.010	C, -, W, -, U

If the main counter is working as a down-counter, the input receives the end value of the main counter via this communication object. This object is visible when parameter "End value specification" is set to "Via communication object".

As long as no correct value telegram is received, the input transmits an interval limit fault. The data format and data point type are set according to the configured "data point type | value range" of the pulse meter (here: pulse meter 0...255).

Object no.	Function	Name	Type	DPT	Flag
786, 806, ..., 926	Pulse meter - Main meter - End value	K n - Input	1-byte	6.010	C, -, W, -, U

If the main counter is working as a down-counter, the input receives the end value of the main counter via this communication object. This object is visible when parameter "End value specification" is set to "Via communication object".

As long as no correct value telegram is received, the input transmits an interval limit fault. The data format and data point type are set according to the configured "data point type | value range" of the pulse meter (here: pulse meter -128...127).

Object no.	Function	Name	Type	DPT	Flag
786, 806, ..., 926	Pulse meter - Main meter - End value	K <i>n</i> - Input	2-byte	7.001	C, -, W, -, U

If the main counter is working as a down-counter, the input receives the end value of the main counter via this communication object. This object is visible when parameter "End value specification" is set to "Via communication object".

As long as no correct value telegram is received, the input transmits an interval limit fault. The data format and data point type are set according to the configured "data point type | value range" of the pulse meter (here: pulse meter 0...65535).

Object no.	Function	Name	Type	DPT	Flag
786, 806, ..., 926	Pulse meter - Main meter - End value	K <i>n</i> - Input	2-byte	8.001	C, -, W, -, U

If the main counter is working as a down-counter, the input receives the end value of the main counter via this communication object. This object is visible when parameter "End value specification" is set to "Via communication object".

As long as no correct value telegram is received, the input transmits an interval limit fault. The data format and data point type are set according to the configured "data point type | value range" of the pulse meter (here: pulse meter -32768...32767).

Object no.	Function	Name	Type	DPT	Flag
786, 806, ..., 926	Pulse meter - Main meter - End value	K <i>n</i> - Input	4-byte	12.001	C, -, W, -, U

If the main counter is working as a down-counter, the input receives the end value of the main counter via this communication object. This object is visible when parameter "End value specification" is set to "Via communication object".

As long as no correct value telegram is received, the input transmits an interval limit fault. The data format and data point type are set according to the configured "data point type | value range" of the pulse meter (here: pulse meter 0...4294967295).

Object no.	Function	Name	Type	DPT	Flag
786, 806, ..., 926	Pulse meter - Main meter - End value	K <i>n</i> - Input	4-byte	13.001	C, -, W, -, U

If the main counter is working as a down-counter, the input receives the end value of the main counter via this communication object. This object is visible when parameter "End value specification" is set to "Via communication object".

As long as no correct value telegram is received, the input transmits an interval limit fault. The data format and data point type are set according to the configured "data point type | value range" of the pulse meter (here: pulse meter -2147483648...2147483647).

Object no.	Function	Name	Type	DPT	Flag
787, 807, ..., 927	Pulse meter - Main meter - Start value	K <i>n</i> - Input	1-byte	5.010	C, -, W, -, U

If the main counter is working as a down-counter, the input receives the start value of the main counter via this communication object. This object is visible if the "Start value specification" parameter is set to "Via communication object".

As long as no correct value telegram is received, the input transmits an interval limit fault. The data format and data point type are set according to the configured "data point type | value range" of the pulse meter (here: pulse meter 0...255).

Object no.	Function	Name	Type	DPT	Flag
787, 807, ..., 927	Pulse meter - Main meter - Start value	K <i>n</i> - Input	1-byte	6.010	C, -, W, -, U

If the main counter is working as a down-counter, the input receives the start value of the main counter via this communication object. This object is visible if the "Start value specification" parameter is set to "Via communication object".

As long as no correct value telegram is received, the input transmits an interval limit fault. The data format and data point type are set according to the configured "data point type | value range" of the pulse meter (here: pulse meter -128...127).

Object no.	Function	Name	Type	DPT	Flag
787, 807, ..., 927	Pulse meter - Main meter - Start value	K <i>n</i> - Input	2-byte	7.001	C, -, W, -, U

If the main counter is working as a down-counter, the input receives the start value of the main counter via this communication object. This object is visible if the "Start value specification" parameter is set to "Via communication object".

As long as no correct value telegram is received, the input transmits an interval limit fault. The data format and data point type are set according to the configured "data point type | value range" of the pulse meter (here: pulse meter 0...65535).

Object no.	Function	Name	Type	DPT	Flag
787, 807, ..., 927	Pulse meter - Main meter - Start value	K <i>n</i> - Input	2-byte	8.001	C, -, W, -, U

If the main counter is working as a down-counter, the input receives the start value of the main counter via this communication object. This object is visible if the "Start value specification" parameter is set to "Via communication object".

As long as no correct value telegram is received, the input transmits an interval limit fault. The data format and data point type are set according to the configured "data point type | value range" of the pulse meter (here: pulse meter -32768...32767).

Object no.	Function	Name	Type	DPT	Flag
787, 807, ..., 927	Pulse meter - Main meter - Start value	K n - Input	4-byte	12.001	C, -, W, -, U

If the main counter is working as a down-counter, the input receives the start value of the main counter via this communication object. This object is visible if the "Start value specification" parameter is set to "Via communication object".

As long as no correct value telegram is received, the input transmits an interval limit fault. The data format and data point type are set according to the configured "data point type | value range" of the pulse meter (here: pulse meter 0...4294967295).

Object no.	Function	Name	Type	DPT	Flag
787, 807, ..., 927	Pulse meter - Main meter - Start value	K n - Input	4-byte	13.001	C, -, W, -, U

If the main counter is working as a down-counter, the input receives the start value of the main counter via this communication object. This object is visible if the "Start value specification" parameter is set to "Via communication object".

As long as no correct value telegram is received, the input transmits an interval limit fault. The data format and data point type are set according to the configured "data point type | value range" of the pulse meter (here: pulse meter -2147483648...2147483647).

Object no.	Function	Name	Type	DPT	Flag
788, 808, ..., 928	Pulse meter - Main meter - Meter reset - Disabling	K n - Input	1-bit	1.003	C, -, W, -, U

Reset of the current main counter status can be disabled via this object. If the "Reset meter by disabling object" parameter is set to "active", the meter reset function can be disabled by this object even if it is enabled in the parameters. During the time it is disabled, the meter cannot be reset. The polarity of the object is defined by the "Object polarity" parameter in the process.

The following communication objects are available for the intermediate meter in the "pulse meter" channel function. The name can be adjusted with the "Name" parameter.

Object no.	Function	Name	Type	DPT	Flag
791, 811, ..., 831	Pulse meter - Inter- mediate meter - Meter run - Status	K n - Output	1-bit	1.002	C, R, -, T, A

This 1-bit object reports that the intermediate counter has elapsed to the KNX. Visible only if the "Meter expiry status object" parameter is set to "active".

Object no.	Function	Name	Type	DPT	Flag
791, 812, ..., 832	Pulse meter - Intermediate meter - Interval limit error - Status	K <i>n</i> - Output	1-bit	1.002	C, R, -, T, A

This 1-bit object reports an intermediate counter interval limit fault to the KNX.

An interval limit error is transmitted if: - Up meter: start value \geq end value, - Down meter: start value \leq end value.

The interval limit fault is also read out if the communication objects "start value" and "end value" have not yet received a valid value telegram via the KNX.

Object no.	Function	Name	Type	DPT	Flag
793, 813, ..., 833	Pulse meter - Intermediate meter - Meter reading - Query	K <i>n</i> - Input	1-bit	1.017	C, -, W, -, U

1-bit object for polling the current intermediate counter status. If this object is defined with a "1" telegram, the device transmits the current meter reading to the KNX.

This communication object is visible only if the "Query meter reading via object" parameter is set to "active".

Object no.	Function	Name	Type	DPT	Flag
794, 814, ..., 834	Pulse meter - Intermediate meter - Meter reset	K <i>n</i> - Input	1-bit	1.015	C, -, W, -, U

1-bit object for resetting the intermediate counter.

If this object is defined with a "1" telegram, the meter reading is reset to the start value that was configured or specified via an object.

This communication object is visible only if the "Meter reset via object" parameter is set to "active".

Object no.	Function	Name	Type	DPT	Flag
795, 815, ..., 835	Pulse meter - Intermediate meter - Meter reading - Status	K <i>n</i> - Output	1-byte	5.010	C, R, -, T, A

This 1-bit object automatically transmits the current meter reading of the intermediate meter on the KNX (after a change or cyclically).

The meter reading can be read out via the KNX if the R-flag is set. The data format and data point type are set according to the configured "data point type | value range" of the pulse meter (here: pulse meter 0...255).

Object no.	Function	Name	Type	DPT	Flag
795, 815, ..., 835	Pulse meter - Intermediate meter - Meter reading - Status	K n - Output	1-byte	6.010	C, R, -, T, A

This 1-bit object automatically transmits the current meter reading of the intermediate meter on the KNX (after a change or cyclically).

The meter reading can be read out via the KNX if the R-flag is set. The data format and data point type are set according to the configured "data point type | value range" of the pulse meter (here: pulse meter -128...127).

Object no.	Function	Name	Type	DPT	Flag
795, 815, ..., 835	Pulse meter - Intermediate meter - Meter reading - Status	K n - Output	2-byte	7.001	C, R, -, T, A

This 2-bit object automatically transmits the current meter reading of the intermediate meter on the KNX (after a change or cyclically).

The meter reading can be read out via the KNX if the R-flag is set. The data format and data point type are set according to the configured "data point type | value range" of the pulse meter (here: pulse meter 0...65535).

Object no.	Function	Name	Type	DPT	Flag
795, 815, ..., 835	Pulse meter - Intermediate meter - Meter reading - Status	K n - Output	2-byte	8.001	C, R, -, T, A

This 2-bit object automatically transmits the current meter reading of the intermediate meter on the KNX (after a change or cyclically).

The meter reading can be read out via the KNX if the R-flag is set. The data format and data point type are set according to the configured "data point type | value range" of the pulse meter (here: pulse meter -32768...32767).

Object no.	Function	Name	Type	DPT	Flag
795, 815, ..., 835	Pulse meter - Intermediate meter - Meter reading - Status	K n - Output	4-byte	12.001	C, R, -, T, A

This 4-bit object automatically transmits the current meter reading of the intermediate meter on the KNX (after a change or cyclically).

The meter reading can be read out via the KNX if the R-flag is set. The data format and data point type are set according to the configured "data point type | value range" of the pulse meter (here: pulse meter 0...4294967295).

Object no.	Function	Name	Type	DPT	Flag
795, 815, ..., 835	Pulse meter - Intermediate meter - Meter reading - Status	K n - Output	4-byte	13.001	C, R, -, T, A

This 4-bit object automatically transmits the current meter reading of the intermediate meter on the KNX (after a change or cyclically).

The meter reading can be read out via the KNX if the R-flag is set. The data format and data point type are set according to the configured "data point type | value range" of the pulse meter (here: pulse meter -2147483648...2147483647).

Object no.	Function	Name	Type	DPT	Flag
796, 816, ..., 836	Pulse meter - Intermediate meter - Start value	K n - Input	1-byte	5.010	C, -, W, -, U

If the intermediate counter is working as an up-counter, the input receives the start value of the intermediate counter via this communication object. This object is visible if the "Start value specification" parameter is set to "Via communication object".

As long as no correct value telegram is received, the input transmits an interval limit fault. The data format and data point type are set according to the configured "data point type | value range" of the pulse meter (here: pulse meter 0...255).

Object no.	Function	Name	Type	DPT	Flag
796, 816, ..., 836	Pulse meter - Intermediate meter - Start value	K n - Input	1-byte	6.010	C, -, W, -, U

If the intermediate counter is working as an up-counter, the input receives the start value of the intermediate counter via this communication object. This object is visible if the "Start value specification" parameter is set to "Via communication object".

As long as no correct value telegram is received, the input transmits an interval limit fault. The data format and data point type are set according to the configured "data point type | value range" of the pulse meter (here: pulse meter -128...127).

Object no.	Function	Name	Type	DPT	Flag
796, 816, ..., 836	Pulse meter - Intermediate meter - Start value	K n - Input	2-byte	7.001	C, -, W, -, U

If the intermediate counter is working as an up-counter, the input receives the start value of the intermediate counter via this communication object. This object is visible if the "Start value specification" parameter is set to "Via communication object".

As long as no correct value telegram is received, the input transmits an interval limit fault. The data format and data point type are set according to the configured "data point type | value range" of the pulse meter (here: pulse meter 0...65535).

Object no.	Function	Name	Type	DPT	Flag
796, 816, ..., 836	Pulse meter - Intermediate meter - Start value	K n - Input	2-byte	8.001	C, -, W, -, U

If the intermediate counter is working as an up-counter, the input receives the start value of the intermediate counter via this communication object. This object is visible if the "Start value specification" parameter is set to "Via communication object".

As long as no correct value telegram is received, the input transmits an interval limit fault. The data format and data point type are set according to the configured "data point type | value range" of the pulse meter (here: pulse meter -32768...32767).

Object no.	Function	Name	Type	DPT	Flag
796, 816, ..., 836	Pulse meter - Intermediate meter - Start value	K n - Input	4-byte	12.001	C, -, W, -, U

If the intermediate counter is working as an up-counter, the input receives the start value of the intermediate counter via this communication object. This object is visible if the "Start value specification" parameter is set to "Via communication object".

As long as no correct value telegram is received, the input transmits an interval limit fault. The data format and data point type are set according to the configured "data point type | value range" of the pulse meter (here: pulse meter 0...4294967295).

Object no.	Function	Name	Type	DPT	Flag
796, 816, ..., 836	Pulse meter - Intermediate meter - Start value	K n - Input	4-byte	13.001	C, -, W, -, U

If the intermediate counter is working as an up-counter, the input receives the start value of the intermediate counter via this communication object. This object is visible if the "Start value specification" parameter is set to "Via communication object".

As long as no correct value telegram is received, the input transmits an interval limit fault. The data format and data point type are set according to the configured "data point type | value range" of the pulse meter (here: pulse meter -2147483648...2147483647).

Object no.	Function	Name	Type	DPT	Flag
797, 817, ..., 837	Pulse meter - Intermediate meter - End value	K n - Input	1-byte	5.010	C, -, W, -, U

If the intermediate counter is working as an up-counter, the input receives the end value of the intermediate counter via this communication object. This object is visible when parameter "End value specification" is set to "Via communication object".

As long as no correct value telegram is received, the input transmits an interval limit fault. The data format and data point type are set according to the configured "data point type | value range" of the pulse meter (here: pulse meter 0...255).

Object no.	Function	Name	Type	DPT	Flag
797, 817, ..., 837	Pulse meter - Intermediate meter - End value	K n - Input	1-byte	6.010	C, -, W, -, U

If the intermediate counter is working as an up-counter, the input receives the end value of the intermediate counter via this communication object. This object is visible when parameter "End value specification" is set to "Via communication object".

As long as no correct value telegram is received, the input transmits an interval limit fault. The data format and data point type are set according to the configured "data point type | value range" of the pulse meter (here: pulse meter -128...127).

Object no.	Function	Name	Type	DPT	Flag
797, 817, ..., 837	Pulse meter - Intermediate meter - End value	K n - Input	2-byte	7.001	C, -, W, -, U

If the intermediate counter is working as an up-counter, the input receives the end value of the intermediate counter via this communication object. This object is visible when parameter "End value specification" is set to "Via communication object".

As long as no correct value telegram is received, the input transmits an interval limit fault. The data format and data point type are set according to the configured "data point type | value range" of the pulse meter (here: pulse meter 0...65535).

Object no.	Function	Name	Type	DPT	Flag
797, 817, ..., 837	Pulse meter - Intermediate meter - End value	K n - Input	2-byte	8.001	C, -, W, -, U

If the intermediate counter is working as an up-counter, the input receives the end value of the intermediate counter via this communication object. This object is visible when parameter "End value specification" is set to "Via communication object".

As long as no correct value telegram is received, the input transmits an interval limit fault. The data format and data point type are set according to the configured "data point type | value range" of the pulse meter (here: pulse meter -32768...32767).

Object no.	Function	Name	Type	DPT	Flag
797, 817, ..., 837	Pulse meter - Intermediate meter - End value	K n - Input	4-byte	12.001	C, -, W, -, U

If the intermediate counter is working as an up-counter, the input receives the end value of the intermediate counter via this communication object. This object is visible when parameter "End value specification" is set to "Via communication object".

As long as no correct value telegram is received, the input transmits an interval limit fault. The data format and data point type are set according to the configured "data point type | value range" of the pulse meter (here: pulse meter 0...4294967295).

Object no.	Function	Name	Type	DPT	Flag
797, 817, ..., 837	Pulse meter - Intermediate meter - End value	K n - Input	4-byte	13.001	C, -, W, -, U
<p>If the intermediate counter is working as an up-counter, the input receives the end value of the intermediate counter via this communication object. This object is visible when parameter "End value specification" is set to "Via communication object".</p> <p>As long as no correct value telegram is received, the input transmits an interval limit fault. The data format and data point type are set according to the configured "data point type value range" of the pulse meter (here: pulse meter -2147483648...2147483647).</p>					

Object no.	Function	Name	Type	DPT	Flag
796, 816, ..., 836	Pulse meter - Intermediate meter - End value	K n - Input	1-byte	5.010	C, -, W, -, U
<p>If the intermediate counter is working as a down-counter, the input receives the end value of the intermediate counter via this communication object. This object is visible when parameter "End value specification" is set to "Via communication object".</p> <p>As long as no correct value telegram is received, the input transmits an interval limit fault. The data format and data point type are set according to the configured "data point type value range" of the pulse meter (here: pulse meter 0...255).</p>					

Object no.	Function	Name	Type	DPT	Flag
796, 816, ..., 836	Pulse meter - Intermediate meter - End value	K n - Input	1-byte	6.010	C, -, W, -, U
<p>If the intermediate counter is working as a down-counter, the input receives the end value of the intermediate counter via this communication object. This object is visible when parameter "End value specification" is set to "Via communication object".</p> <p>As long as no correct value telegram is received, the input transmits an interval limit fault. The data format and data point type are set according to the configured "data point type value range" of the pulse meter (here: pulse meter -128...127).</p>					

Object no.	Function	Name	Type	DPT	Flag
796, 816, ..., 836	Pulse meter - Intermediate meter - End value	K n - Input	2-byte	7.001	C, -, W, -, U
<p>If the intermediate counter is working as a down-counter, the input receives the end value of the intermediate counter via this communication object. This object is visible when parameter "End value specification" is set to "Via communication object".</p> <p>As long as no correct value telegram is received, the input transmits an interval limit fault. The data format and data point type are set according to the configured "data point type value range" of the pulse meter (here: pulse meter 0...65535).</p>					

Object no.	Function	Name	Type	DPT	Flag
796, 816, ..., 836	Pulse meter - Intermediate meter - End value	K n - Input	2-byte	8.001	C, -, W, -, U
<p>If the intermediate counter is working as a down-counter, the input receives the end value of the intermediate counter via this communication object. This object is visible when parameter "End value specification" is set to "Via communication object".</p> <p>As long as no correct value telegram is received, the input transmits an interval limit fault. The data format and data point type are set according to the configured "data point type value range" of the pulse meter (here: pulse meter -32768...32767).</p>					
796, 816, ..., 836	Pulse meter - Intermediate meter - End value	K n - Input	4-byte	12.001	C, -, W, -, U
<p>If the intermediate counter is working as a down-counter, the input receives the end value of the intermediate counter via this communication object. This object is visible when parameter "End value specification" is set to "Via communication object".</p> <p>As long as no correct value telegram is received, the input transmits an interval limit fault. The data format and data point type are set according to the configured "data point type value range" of the pulse meter (here: pulse meter 0...4294967295).</p>					
796, 816, ..., 836	Pulse meter - Intermediate meter - End value	K n - Input	4-byte	13.001	C, -, W, -, U
<p>If the intermediate counter is working as a down-counter, the input receives the end value of the intermediate counter via this communication object. This object is visible when parameter "End value specification" is set to "Via communication object".</p> <p>As long as no correct value telegram is received, the input transmits an interval limit fault. The data format and data point type are set according to the configured "data point type value range" of the pulse meter (here: pulse meter -2147483648...2147483647).</p>					
797, 817, ..., 837	Pulse meter - Intermediate meter - Start value	K n - Input	1-byte	5.010	C, -, W, -, U
<p>If the intermediate counter is working as a down-counter, the input receives the start value of the intermediate counter via this communication object. This object is visible if the "Start value specification" parameter is set to "Via communication object".</p> <p>As long as no correct value telegram is received, the input transmits an interval limit fault. The data format and data point type are set according to the configured "data point type value range" of the pulse meter (here: pulse meter 0...255).</p>					

Object no.	Function	Name	Type	DPT	Flag
797, 817, ..., 837	Pulse meter - Intermediate meter - Start value	K n - Input	1-byte	6.010	C, -, W, -, U

If the intermediate counter is working as a down-counter, the input receives the start value of the intermediate counter via this communication object. This object is visible if the "Start value specification" parameter is set to "Via communication object".

As long as no correct value telegram is received, the input transmits an interval limit fault. The data format and data point type are set according to the configured "data point type | value range" of the pulse meter (here: pulse meter -128...127).

Object no.	Function	Name	Type	DPT	Flag
797, 817, ..., 837	Pulse meter - Intermediate meter - Start value	K n - Input	2-byte	7.001	C, -, W, -, U

If the intermediate counter is working as a down-counter, the input receives the start value of the intermediate counter via this communication object. This object is visible if the "Start value specification" parameter is set to "Via communication object".

As long as no correct value telegram is received, the input transmits an interval limit fault. The data format and data point type are set according to the configured "data point type | value range" of the pulse meter (here: pulse meter 0...65535).

Object no.	Function	Name	Type	DPT	Flag
797, 817, ..., 837	Pulse meter - Intermediate meter - Start value	K n - Input	2-byte	8.001	C, -, W, -, U

If the intermediate counter is working as a down-counter, the input receives the start value of the intermediate counter via this communication object. This object is visible if the "Start value specification" parameter is set to "Via communication object".

As long as no correct value telegram is received, the input transmits an interval limit fault. The data format and data point type are set according to the configured "data point type | value range" of the pulse meter (here: pulse meter -32768...32767).

Object no.	Function	Name	Type	DPT	Flag
797, 817, ..., 837	Pulse meter - Intermediate meter - Start value	K n - Input	4-byte	12.001	C, -, W, -, U

If the intermediate counter is working as a down-counter, the input receives the start value of the intermediate counter via this communication object. This object is visible if the "Start value specification" parameter is set to "Via communication object".

As long as no correct value telegram is received, the input transmits an interval limit fault. The data format and data point type are set according to the configured "data point type | value range" of the pulse meter (here: pulse meter 0...4294967295).

Object no.	Function	Name	Type	DPT	Flag
797, 817, ..., 837	Pulse meter - Intermediate meter - Start value	K n - Input	4-byte	13.001	C, -, W, -, U
<p>If the intermediate counter is working as a down-counter, the input receives the start value of the intermediate counter via this communication object. This object is visible if the "Start value specification" parameter is set to "Via communication object".</p> <p>As long as no correct value telegram is received, the input transmits an interval limit fault. The data format and data point type are set according to the configured "data point type value range" of the pulse meter (here: pulse meter -2147483648...2147483647).</p>					

Object no.	Function	Name	Type	DPT	Flag
798, 818, ..., 838	Pulse meter - Intermediate meter - Meter reset - Disabling	K n - Input	1-bit	1.003	C, -, W, -, U
<p>Reset of the current intermediate counter status can be disabled via this object. If the "Reset meter by disabling object" parameter is set to "active", the meter reset function can be disabled by this object even if it is enabled in the parameters. During the time it is disabled, the meter cannot be reset. The polarity of the object is defined by the "Object polarity" parameter in the process.</p>					

8.7 Output

The "output" channel function can be parameterised for each channel. An LED or an electronic relay can be connected to the output and actuated via the bus. The object polarity can be parameterised.

With the LED connected, the channel can implement different application cases in combination with the logic functions (see chapter "Applications" ▶ Page 231).

8.7.1 Applications

This chapter describes a selection of implementable application cases of the "output" channel function.

The cases are implemented in combination with the available logic functions. The logic functions are enabled on the "General" parameter page and parameterised on separate parameter pages. The output is connected via group addresses by the communication objects with the logic functions.

- i** Any evaluation of a forced position object can be performed directly by means of the status of the actuator and visualised by means of the output of the push-button interface.

8.7.1.1 flashing

The "flashing" application case can visualise an alarm with the LED connected to the output.

As soon as the device receives a 1-bit KNX telegram for the initiation of an alarm by means of the communication object "Logic gate (Inverter) - Input 1", an LED connected to the channel LED can flash in the "output" channel function.

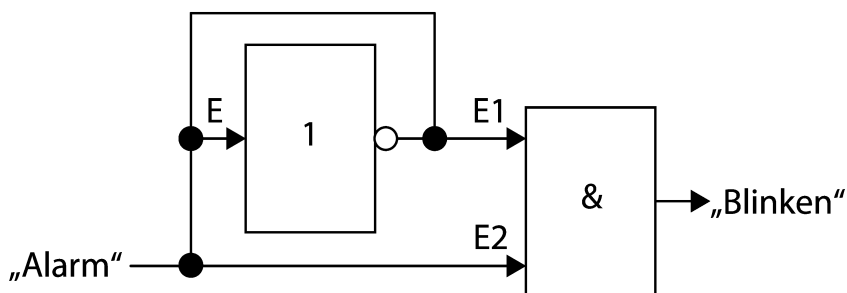

Figure 20: "Flashing" diagram

Example: parameterisation for "flashing" application case
Number of logic functions = 2
Channel function = output
Object polarity = 1 = ON / 0 = OFF
Type of logic function n = logic gate
Selection: Logic gate = Invert (NOT)

Example: parameterisation for "flashing" application case
Transmission criterion = always transmit when the inputs are updated
Delay for transmission of the result = 1 s
Type of logic function m = logic gate
Selection: Logic gate = AND
Input 1 = input object, Invert input = inactive
Input 2 = input object, Invert input = inactive
Input 3 = deactivated
Input 4 = deactivated
Transmission criterion = transmit only if the output changes
Delay for transmission of the result = 0 s

For the implementation of the "flashing" application case, six communication objects are to be connected via three group addresses as illustrated in the "Flashing" diagram in the parameterisation example.

Example: connecting objects for "flashing" application case
Group address 1
Logic n - Input / logic gate (inverter) input 1
Logic m - Input / logic gate (AND) input 2
Group address 2
Logic n - Input / logic gate (inverter) input 1
Logic m - Input / logic gate (AND) input 1
Logic n - Output / Logic gate output
Group address 3
K n - Input / output - Switching
Logic m - Output / Logic gate output

8.7.1.2 Timing functions

The "time functions" application case can be used to switch on the LED connected to the output after a delay, switch it off after a delay or switch it on and off after a delay.

Delayed switch-on

As soon as the device receives a 1-bit KNX telegram for the initiation of the delayed switch-on process by means of the "Disabling element input" communication object, an LED connected to the channel can flash after a delay in the "output" channel function.

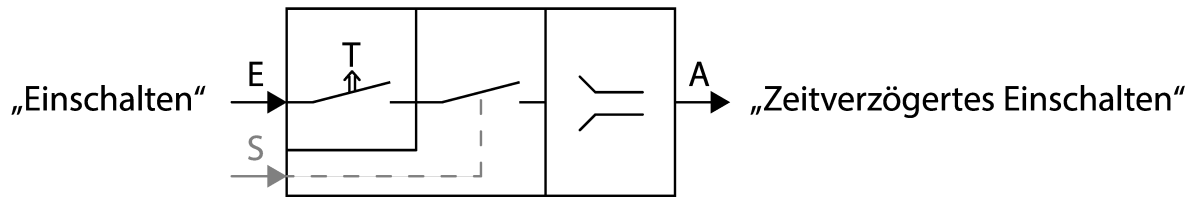

Figure 21: "Delayed switch-on" diagram

Example: parameterisation for "delayed switch-on" application case
Number of logic functions = 1
Channel function = output
Object polarity = 1 = ON / 0 = OFF
Type of logic function n = disabling element (filtering/time)
Time function = delay only ON telegrams
Delay for ON telegrams = 10 s
Disabling object polarity = 0 = enabled / 1 = disabled
Filter function = ON -> ON / OFF -> OFF
Transmission criterion = always transmit when the input is updated

For the implementation of the "delayed switch-on" application case, three communication objects are to be connected via two group addresses as illustrated in the "Delayed switch-on" diagram in the parameterisation example.

The communication object "Logic n - Input / Disabling element Disabling function" is not used in this application case.

Example: connecting objects for "delayed switch-on" application case
Group address 1 Logic n - Input / Disabling element input
Group address 2 K n - Input / output - Switching Logic n - Output / Disabling element output

i KNX telegrams used to switch off the output are processed without delay.

Delayed switch-off

As soon as the device receives a 1-bit KNX telegram for the initiation of the delayed switch-off process by means of the "Disabling element input" communication object, an LED connected to the channel can be switched off after a delay in the "output" channel function.

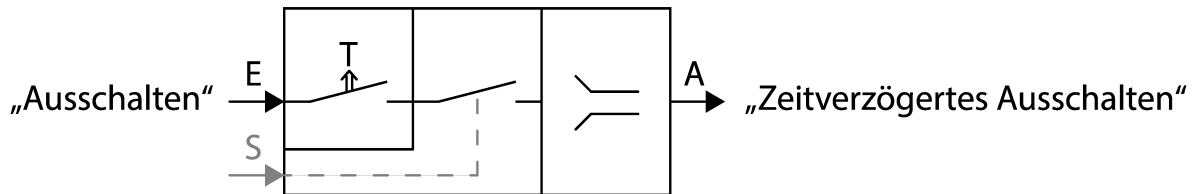

Figure 22: "Delayed switch-off" diagram

Example: parameterisation for "delayed switch-off" application case
Number of logic functions = 1
Channel function = output
Object polarity = 1 = ON / 0 = OFF
Type of logic function n = disabling element (filtering/time)
Time function = delay only OFF telegrams
Delay for OFF telegrams = 10 s
Disabling object polarity = 0 = enabled / 1 = disabled
Filter function = ON -> ON / OFF -> OFF
Transmission criterion = always transmit when the input is updated

For the implementation of the "delayed switch-off" application case, three communication objects are to be connected via two group addresses as illustrated in the "Delayed switch-off" diagram in the parameterisation example.

The communication object "Logic n - Input / Disabling element Disabling function" is not used in this application case.

Example: connecting objects for "delayed switch-off" application case
Group address 1 Logic n - Input / Disabling element input
Group address 2 K n - Input / output - Switching Logic n - Output / Disabling element output

i KNX telegrams used to switch on the output are processed without delay.

Delayed switch-on and switch-off

As soon as the device receives 1-bit KNX telegrams for the initiation of the delayed switch-off process by means of the "Disabling element input" communication object, an LED connected to the channel can be switched on and off after a delay in the "output" channel function.

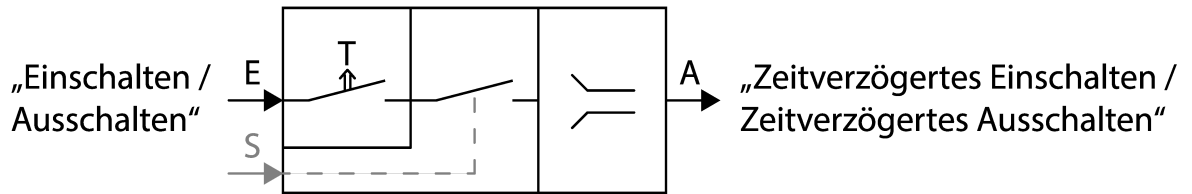

Figure 23: "Delayed switch-on and switch-off" diagram

Example: parameterisation for "delayed switch-on and switch-off" application case
Number of logic functions = 1
Channel function = output
Object polarity = 1 = ON / 0 = OFF
Type of logic function n = disabling element (filtering/time)
Time function = delay ON and OFF telegrams
Delay for ON telegrams = 5 s
Delay for OFF telegrams = 10 s
Disabling object polarity = 0 = enabled / 1 = disabled
Filter function = ON -> ON / OFF -> OFF
Transmission criterion = always transmit when the input is updated

For the implementation of the "delayed switch-on and switch-off" application case, three communication objects are to be connected via two group addresses as illustrated in the "Delayed switch-on and switch-off" diagram in the parameterisation example.

The communication object "Logic n - Input / Disabling element Disabling function" is not used in this application case.

Example: connecting objects for "delayed switch-on and switch-off" application case
Group address 1 Logic n - Input / Disabling element input
Group address 2 K n - Input / output - Switching Logic n - Output / Disabling element output

Staircase function (delayed switch-off, triggerable)

As soon as the device receives a 1-bit KNX telegram for the initiation of the delayed switch-off process by means of the "Disabling element input" communication object, an LED connected to the channel can be switched off after a delay in the "output" channel function. The LED is switched off after a delay again if there are new KNX telegrams.

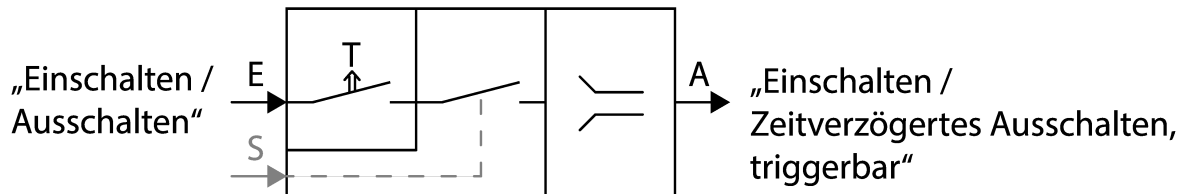

Figure 24: "Staircase function" diagram

Example: parameterisation for "staircase function" application case
Number of logic functions = 1
Channel function = output
Object polarity = 1 = ON / 0 = OFF
Type of logic function n = disabling element (filtering/time)
Time function = delay only OFF telegrams
Delay for OFF telegrams = 1 min
Disabling object polarity = 0 = enabled / 1 = disabled
Filter function = ON -> ON / OFF -> OFF
Transmission criterion = transmit only if the output changes

For the implementation of the "staircase function" application case, three communication objects are to be connected via two group addresses as illustrated in the "staircase function" diagram in the parameterisation example.

The communication object "Logic n - Input / Disabling element Disabling function" is not used in this application case.

Example: connecting objects for "staircase function" application case
Group address 1 Logic n - Input / Disabling element input
Group address 2 K n - Input / output - Switching Logic n - Output / Disabling element output

i KNX telegrams used to switch on the output are processed without delay.

8.7.1.3 Disabling function

The output can be disabled in the "disabling function" application case.

A channel at the "output" channel function can be disabled as soon as the device receives a 1-bit KNX telegram for the initiation of the disabling by means of the communication object "Disabling element Disabling function".

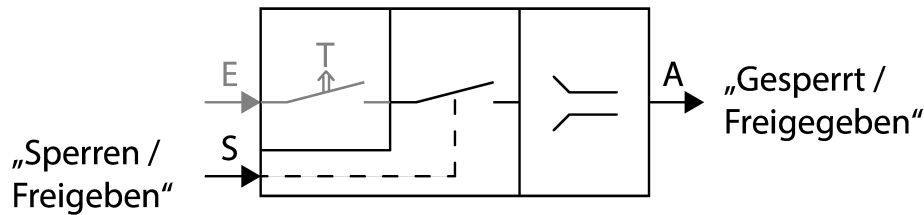

Figure 25: "Disabling function" diagram

Example: parameterisation for "disabling function" application case
Number of logic functions = 1
Channel function = output
Object polarity = 1 = ON / 0 = OFF
Type of logic function n = disabling element (filtering/time)
Time function = no delay
Filter function = ON -> ON / OFF -> OFF
Transmission criterion = always transmit when the input is updated

For the implementation of the "disabling function" application case, four communication objects are to be connected via three group addresses as illustrated in the "Disabling function" diagram in the parameterisation example.

Example: connecting objects for "disabling function" application case
Group address 1 Logic n - Input / Disabling element input
Group address 2 K n - Input / output - Switching Logic n - Output / Disabling element output
Group address 3 Logik n - Input / Disabling element Disabling function

8.7.1.4 Status indication reference value

In the "status indication reference value" application case, the LED connected to the output can light up depending on the value received. Different value telegrams can be received.

As soon as the device receives a value telegram for the initiation of the comparison-based switch-on and switch-off processes by means of the "comparator input" communication object, an LED connected to the channel can be switched on and off in the "output" channel function.

Example: parameterisation for "status indication references value" application case
Number of logic functions = 1
Channel function = output

Example: parameterisation for "status indication references value" application case
Object polarity = 1 = ON / 0 = OFF
Type of logic function n = comparator
Data format = 1-byte value 0...255 (DPT 5.010)
Reference function = greater than or equal ($E \geq V$)
Reference value (V) = 150
Transmission criterion = transmit only if the output changes

For the implementation of the "status indication reference value" application case, three communication objects are to be connected via two group addresses as illustrated in the "Status indication reference value" diagram in the parameterisation example.

Example: connecting objects for "status indication references value" application case
Group address 1 Logic n - Input / Comparator input
Group address 2 K n - Input / output - Switching Logic n - Output / Comparator output

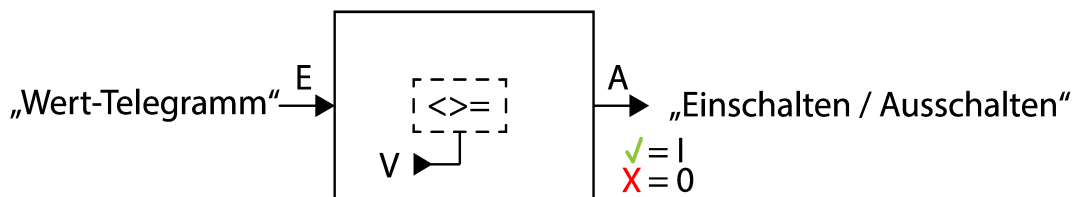

Figure 26: "Status indication reference value" diagram

i KNX telegrams used to switch off the output are processed without delay.

8.7.2 Table of parameters

The following parameter is available in the "output" channel function.

Object polarity	1 = ON / 0 = OFF 0 = ON / 1 = OFF
This parameter defines the value of the output object at which the channels is actuated.	

8.7.3 Object list

The following communication objects are available in the "output" channel function. The name can be adjusted with the "Name" parameter.

Object no.	Function	Name	Type	DPT	Flag
5, 10, ..., 40	Output - Switching	K <i>n</i> - Input	1-bit	1,001	C, -, W, -, U
1-bit object for receiving switching telegrams (ON, OFF). The output channel is actuated according to the parameterisation.					

9 Channel-independent device functions

The following subchapters provide a description of the device functions. Each subchapter consists of the following sections:

- Functional description
- Table of parameters
- Object list

Functional description

The functional description explains the function and provides helpful tips on project design and usage of the function. Cross references support you in your search for further information.

Table of parameters

The table of parameters lists all parameters associated with the function. Each parameter is documented in a table as follows.

Name of the parameter	Parameter values
Parameter description	

Object list

The object list specifies and describes all communication objects associated with the function. Each communication object is documented in a table.

Object no.	This column contains the object number of the communication object.
Function	This column contains the function of the communication object.
Name	This column contains the name of the communication object.
Type	This column contains the length of the communication object.
DPT	This column assigns a datapoint type to a communication object. Datapoint types are standardized in order to ensure interoperability of KNX devices.
Flag	This column assigns the communication flags in accordance with the KNX specification.
C flag	activates / deactivates the communication of the communication object
R flag	enables externally triggered reading of the value from the communication object
W flag	enables externally triggered writing of the value to the communication object
T flag	enables transfer of a value
U flag	enables updating of an object value in case of feedback
I flag	enforces updating of the communication object value when the devices is switched on (reading at init)

9.1 Logic functions

The device contains up to 8 logic functions. Simple or complex logical operations in a KNX installation can be performed using these functions. Linking of input and output objects allows the networking of logic functions, permitting the execution of complex operations.

Enabling and configuring the number of logic functions

To be able to use logic functions, they must be enabled centrally on the "General" parameter page.

- Activate the parameter "Logic functions".

The logic functions can be used. The "Logic functions" parameter node becomes available, which contains additional parameter pages. The configuration of the logic functions takes place in this parameter node.

Logic functions can be enabled in steps so that the number of visible functions and, in consequence, the available parameters and communication objects are visible in the ETS. The number of available logic functions can be defined on the "General" parameter page.

- Configure the "Number of logic functions" parameter to the desired value.
As many logic functions are created as have been selected.

i The application program deletes existing logic functions from the configuration if the number of available functions is reduced.

9.1.1 Logic functions parameters

General

Logic functions	Checkbox (yes/no)
This parameter enables the logic functions globally. If the parameter is activated, the "Logic functions" parameter node becomes available, which contains additional parameter pages. The configuration of the logic functions takes place in this parameter node.	

Number of logic functions (1...8)	1...8
The number of required logic functions is defined here.	

Logic functions -> Logic function...

Name of logic function	Free text
The text entered in this parameter is applied to the name of the communication objects and is used to label the logic function in the ETS parameter window (e. g. "limit value switch outside temperature", disabling of venetian blind garden door). The text is not programmed in the device.	

Type of logic function	Logic gate Converter (1-bit -> 1-byte) Disabling element (Filtering/Time) Comparator Limit value switch with hysteresis
<p>It is possible to be define which logical operation is to be executed for each logic function. This parameter is only visible if the logic functions have been enabled on the "General" parameter page.</p> <p>Logic gate: The logic function works as a Boolean logic gate with optionally 1 ... 4 inputs and one output.</p> <p>Converter (1-bit -> 1-byte): The logic function is configured as a converter. The converter has a 1-bit input and a 1-byte output and also a disabling object. ON / OFF telegrams can be converted to preconfigured values. The disabling object is able to deactivate the converter.</p> <p>Disabling element (Filtering/Time): The logic function is configured as a disabling element. The disabling element has a 1-bit input and a 1-bit output. This logic function can delay input signals depending on the state (ON or OFF) and output them filtered at the output. A disabling object is also available, which can be used to deactivate the disabling element.</p> <p>Comparator: The logic function works as a comparator with an input whose data format can be parameterised, and with a 1-bit output to output the result of the comparison operation. The reference function and the reference value are configured in the ETS.</p> <p>Limit value switch with hysteresis: The logic function acts like a limit switch with hysteresis. An input with a configurable data format and a 1-bit output are available. The hysteresis is determined by an upper and lower threshold. The threshold values can be parameterised in the ETS. The input value is compared with the threshold values. The command at the output (ON / OFF) upon exceeding or falling below the configured threshold values can be configured.</p>	

9.1.2 Logic gate

A logic gate has up to 4 Boolean inputs (1-bit) and one logic output (1-bit). In consequence, a logic operation only supports the 1-bit data format. The following table shows configurable comparison operations Logic gate and explains their function.

Logic gate	Description	Icon
Invert (NOT)	The logic gate has only one input. The input is forwarded to the gate output inverted.	
AND (AND)	Logic gate has 4 inputs. The output is "1" if all inputs are "1". Otherwise the output is "0".	
OR (OR)	Logic gate has 4 inputs. The output is "0" if all inputs are "0". Otherwise the output is "1".	
Exclusive OR (XOR)	Logic gate has 4 inputs. The output is "1" if only one input is "1". Otherwise the output is "0".	
Inverted AND (NAND)	Logic gate has 4 inputs. The output is "0" if all inputs are "1". Otherwise the output is "1".	
Inverted OR (NOR)	Logic gate has 4 inputs. The output is "1" if all inputs are "0". Otherwise the output is "0".	
Inverted Exclusive OR (NXOR)	Logic gate has 4 inputs. The output is "0" if only one input is "1". Otherwise the output is "1".	
AND with feedback (ANDR)	Logic gate has 4 inputs. The output is fed back to the first input of the gate. The output is "1" if all inputs are "1". Otherwise the output is "0". If input 1 is set to "1" and the output is still "0", the feedback of input 1 is also reset to "0". Only when	

Logic gate	Description	Icon
	<p>inputs 2 ... 4 are "1" will a newly received "1" at input 1 cause the output to assume the logical state "1".</p> <p>Application: Switch light manually only at twilight -> Switch on input 1, twilight sensor on input 2 -> The manual switching signal is ignored for as long as the twilight sensor has not issued an enabling signal. The manual switching sign is only executed at twilight.</p>	

Inputs of a logic gate can be activated or deactivated separately. This allows gates with an individual number of inputs (1 ... 4) to be implemented. As an option, it is possible to invert inputs.

The transmission behaviour of the gate output can be configured.

9.1.2.1 Logic gate parameters

Logic functions -> Logic function...

Selection logic gate	Invert (NOT) AND (AND) OR (OR) Exclusive OR (XOR) Inverted AND (NAND) Inverted OR (NOR) Inverted Exclusive OR (NXOR) AND with feedback (ANDR)
<p>This parameter defines the function of the logic gate and is only visible if "Type of logic function = logic gate".</p> <p>Invert (NOT): The inverter is configured. The gate has one input and one output. The Boolean data value of the input is forwarded to the output inverted.</p> <p>And (AND): An AND gate is configured. The gate has 1...4 inputs and one output. The inputs are logically AND-linked. The result is forwarded to the output.</p> <p>OR (OR): An OR gate is configured. The gate has 1...4 inputs and one output. The inputs are logically OR-linked. The result is forwarded to the output.</p> <p>Exclusive-OR (XOR): An exclusive-OR gate is configured. The gate has 1...4 inputs and one output. The inputs are logically Exclusive-OR-linked. The result is forwarded to the output.</p> <p>Inverted AND (NAND): An AND gate is configured. The gate has 1...4 inputs and one output. The inputs are logically AND-linked. The result is forwarded to the output inverted.</p> <p>Inverted OR (NOR): An OR gate is configured. The gate has 1...4 inputs and one output. The inputs are logically OR-linked. The result is forwarded to the output inverted.</p> <p>Inverted Exclusive OR (NXOR): An inverted Exclusive OR gate is configured. The gate has 1...4 inputs and one output. The inputs are logically Exclusive-OR-linked. The result is forwarded to the output inverted.</p> <p>AND with feedback (ANDR): An AND gate with feedback is configured. The gate has 1...4 inputs and one output. The output is fed back to the first input of the gate.</p>	
Input 1	deactivated Input object
<p>Inputs of a logic gate can be activated or deactivated separately. This allows gates with an individual number of inputs (1 ... 4) to be implemented. This parameter defines whether the first input of the gate should be used.</p> <p>This parameter is only visible if "Type of logic function = logic gate".</p>	

Input 2	deactivated Input object
<p>Inputs of a logic gate can be activated or deactivated separately. This allows gates with an individual number of inputs (1 ... 4) to be implemented. This parameter defines whether the second input of the gate should be used.</p> <p>This parameter is only visible if "Type of logic function = logic gate".</p>	
Input 3	deactivated Input object
<p>Inputs of a logic gate can be activated or deactivated separately. This allows gates with an individual number of inputs (1 ... 4) to be implemented. This parameter defines whether the third input of the gate should be used.</p> <p>This parameter is only visible if "Type of logic function = logic gate".</p>	
Input 4	deactivated Input object
<p>Inputs of a logic gate can be activated or deactivated separately. This allows gates with an individual number of inputs (1 ... 4) to be implemented. This parameter defines whether the fourth input of the gate should be used.</p> <p>This parameter is only visible if "Type of logic function = logic gate".</p>	
Invert input	Checkbox (yes/no)
<p>It is possible to invert inputs of the logic gate as an option. This parameter is available for each input of the gate and defines whether the respective input should be evaluated unchanged or inverted.</p> <p>This parameter is only visible if "Type of logic function = logic gate".</p>	
Transmission criteria	always transmit when the input is updated transmit only if the output changes transmit cyclically
<p>The transmission behaviour of the output can be configured here.</p> <p>Always transmit when the input is updated: The output transmits the current object value to the KNX with every telegram that is received at the input.</p> <p>Transmit only if the output changes: The output only transmits the current object value if the object value has changed compared to the last transmission process. During the first telegram to an input after bus voltage return or after an ETS programming operation, the output always transmits to an input.</p> <p>Transmit cyclically: With this setting, the output transmits the current object value to the KNX cyclically. After bus voltage return or after an ETS programming operation, the cyclical transmission is only started once the first telegram has been received at the input. The output also transmits as soon as a new telegram is received at the input. At the same time, the cycle time for cyclical transmission is restarted!</p>	

Transmission delay for sending the hours result (0...99)	0...99
<p>An optional delay before result transmission (telegram at output) can be configured.</p> <p>With the setting "always transmit when the input is updated": Telegrams at the output are only transmitted after the trigger when the delay has elapsed. The delay time is restarted by each telegram at the input.</p> <p>With the setting "only transmit if the output changes": Telegrams are only sent when the object value changes at the output if the delay has expired. If the logic function is reprocessed by a new telegram at the input within the delay time and the object value changes again, then the delay restarts. If the object value of the output does not change due to new input telegrams, the delay does not restart.</p> <p>This parameter defines the hours of the delay time.</p>	
Minutes (0...59)	0...59
<p>This parameter defines the minutes of the delay time.</p>	
Seconds (0...59)	0...59
<p>This parameter defines the seconds of the delay time.</p> <p>The parameters for the transmission delay are only visible for "Transmission criteria" = "Always transmit when the input is updated" and "Only transmit when the output changes".</p>	
Cycle time hours (0...99)	0...99
<p>During cyclical transmission of the output, this parameter defines the cycle time.</p> <p>Setting the cycle time hours.</p>	
Minutes (0...59)	0...5...59
<p>This parameter defines the minutes of the cycle time.</p>	
Seconds (0...59)	0...59
<p>This parameter defines the seconds of the cycle time.</p> <p>The parameters for the cycle time are only visible if "transmission criteria" = "transmit cyclically".</p>	

9.1.2.2 Object list for logic gate

Object no.	Function	Name	Type	DPT	Flag
45, 49, ..., 73	Logic gate... Input 1	Logic... - Input	1-bit	1.002	C, -, W, -, U

1-bit object as input 1 of a logic gate (1...8). The input status can be inverted optionally.

This object is only available if the type of logic function is configured to "logic gate" and input 1 is used.

Object no.	Function	Name	Type	DPT	Flag
46, 50, ..., 74	Logic gate... Input 2	Logic... - Input	1-bit	1.002	C, -, W, -, U

1-bit object as input 2 of a logic gate (1...8). The input status can be inverted optionally.

This object is only available if the type of logic function is configured to "logic gate" and input 2 is used.

Object no.	Function	Name	Type	DPT	Flag
47, 51, ..., 75	Logic gate... Input 3	Logic... - Input	1-bit	1.002	C, -, W, -, U

1-bit object as input 3 of a logic gate (1...8). The input status can be inverted optionally.

This object is only available if the type of logic function is configured to "logic gate" and input 3 is used.

Object no.	Function	Name	Type	DPT	Flag
48, 52, ..., 76	Logic gate... Input 4	Logic... - Input	1-bit	1.002	C, -, W, -, U

1-bit object as input 4 of a logic gate (1...8). The input status can be inverted optionally.

This object is only available if the type of logic function is configured to "logic gate" and input 4 is used.

Object no.	Function	Name	Type	DPT	Flag
133, 135, ..., 147	Logic gate output	Logic... - Output	1-bit	1.002	C, R, -, T, A

1-bit object as output of a logic gate (1...8).

This object is only available if the type of logic function is configured to "logic gate".

9.1.3 Converter (1-bit -> 1-byte)

The converter has a 1-bit input and a 1-byte output and also a disabling object. ON / OFF telegrams can be converted to preconfigured values. The disabling object is able to deactivate the converter.

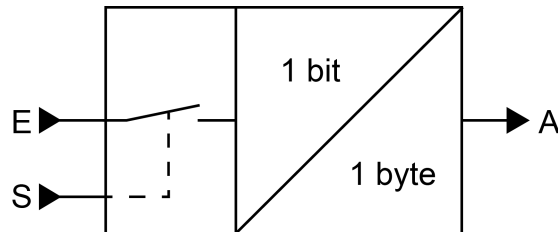

Figure 27: Converter (1-bit -> 1-byte)

The converter can react differently to input states. The parameter "Reaction at input to" defines whether the converter responds to ON and OFF commands or alternatively only processes ON or OFF telegrams.

A concrete 1-byte output value can be assigned to each 1-bit input status. The two output values can be configured anywhere in the range 0 ... 255 as required. The data format of the converter output object is set to DPT 5.001 (0...100%).

The disabling object can be deactivated via the converter. A deactivated converter no longer processes input states and consequently does not convert any new output values (the last value is retained and transmitted cyclically, if necessary). At the end of a disabling function, the converter is enabled again. The converter then waits for the next telegram at the input.

The telegram polarity of the disabling object can be configured.

The transmission behaviour of the converter output can be configured.

9.1.3.1 Converter parameters

Logic functions -> Logic function...

Reaction at input to	ON and OFF telegrams ON telegrams OFF telegrams
The converter can react differently to input states. It is defined here whether the converter responds to ON and OFF commands or alternatively only processes ON or OFF telegrams.	
Polarity of the disabling object	0 = enabled / 1 = disabled 0 =disabled/ 1 = enabled
This parameter defines the polarity of the disabling object.	
Output value for ON (0...255)	0...255
A concrete 1-byte output value can be assigned to each 1-bit input status. This parameter defines the output value for ON telegrams. This parameter is only visible when the input should react to ON telegrams.	
Output value for OFF (0...255)	0...255
A concrete 1-byte output value can be assigned to each 1-bit input status. This parameter defines the output value for OFF telegrams. This parameter is only visible when the input should react to OFF telegrams.	
Transmission criteria	always transmit when the input is updated transmit only if the output changes transmit cyclically
<p>The transmission behaviour of the output can be configured here.</p> <p>Always transmit when the input is updated: The output transmits the current object value to the KNX with every telegram that is received at the input.</p> <p>Transmit only if the output changes: The output only transmits the current object value if the object value has changed compared to the last transmission process. During the first telegram to an input after bus voltage return or after an ETS programming operation, the output always transmits to an input.</p> <p>Transmit cyclically: With this setting, the output transmits the current object value to the KNX cyclically. After bus voltage return or after an ETS programming operation, the cyclical transmission is only started once the first telegram has been received at the input. The output also transmits as soon as a new telegram is received at the input. At the same time, the cycle time for cyclical transmission is restarted!</p>	

Transmission delay for sending the hours result (0...99)	0...99
<p>An optional delay before result transmission (telegram at output) can be configured.</p> <p>With the setting "always transmit when the input is updated": Telegrams at the output are only transmitted after the trigger when the delay has elapsed. The delay time is restarted by each telegram at the input.</p> <p>With the setting "only transmit if the output changes": Telegrams are only sent when the object value changes at the output if the delay has expired. If the logic function is reprocessed by a new telegram at the input within the delay time and the object value changes again, then the delay restarts. If the object value of the output does not change due to new input telegrams, the delay does not restart.</p> <p>This parameter defines the hours of the delay time.</p>	
Minutes (0...59)	0...59
<p>This parameter defines the minutes of the delay time.</p>	
Seconds (0...59)	0...59
<p>This parameter defines the seconds of the delay time.</p> <p>The parameters for the transmission delay are only visible for "Transmission criteria" = "Always transmit when the input is updated" and "Only transmit when the output changes".</p>	
Cycle time hours (0...99)	0...99
<p>During cyclical transmission of the output, this parameter defines the cycle time.</p> <p>Setting the cycle time hours.</p>	
Minutes (0...59)	0...5...59
<p>This parameter defines the minutes of the cycle time.</p>	
Seconds (0...59)	0...59
<p>This parameter defines the seconds of the cycle time.</p> <p>The parameters for the cycle time are only visible if "transmission criteria" = "transmit cyclically".</p>	

9.1.3.2 Object list for converter

Object no.	Function	Name	Type	DPT	Flag
45, 49, ..., 73	Converter Input	Logic... - Input	1-bit	1.002	C, (R), W, -, A
<p>1-bit object as input of a converter. It is possible to configure whether the converter responds to ON and OFF commands or alternatively processes only ON or only OFF telegrams.</p> <p>This object is only available if the type of logic function is configured to "converter".</p>					
Object no.	Function	Name	Type	DPT	Flag
46, 50, ..., 74	Converter Disabling function	Logic... - Input	1-bit	1.002	C, (R), W, -, A
<p>1-bit object as disabling input of a converter. A disabled converter no longer processes input states and consequently does not convert any new output values (the last value is retained and transmitted cyclically, if necessary).</p> <p>The telegram polarity can be configured.</p> <p>This object is only available if the type of logic function is configured to "converter".</p>					
Object no.	Function	Name	Type	DPT	Flag
181, 182, ..., 188	Converter Output	Logic... - Output	1-byte	5.001	C, (R), -, T, A
<p>1-byte object as value output of a converter.</p> <p>This object is only available if the type of logic function is configured to "converter".</p>					

9.1.4 Disabling element (Filtering/Time)

The disabling element has a 1-bit input and a 1-bit output as well as a disabling object. Input states (ON/OFF) can be delayed independently of one another and filtered at the output before output. The filter makes it possible to invert the states of the output (e.g. ON -> OFF) or to suppress it completely (e.g. OFF -> ---, OFF is not transmitted). If the filter is not used, the disabling element only works with the time functions if required. Alternatively, it is possible to use only the filter (without delays).

The disabling object is able to deactivate the disabling element.

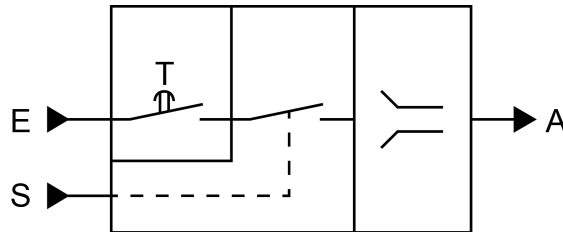

Figure 28: Disabling element (Filtering/Time)

The parameter "Time function" defines whether ON or OFF telegrams or both states are evaluated with a delay after reception at the input. If a delay is provided, the delay time can be configured separately for ON and OFF telegrams. A delay is only effective if the delay time is set to greater than "0". Each telegram received at the input re-triggers the receptive delay time.

If no delay is configured, the input telegrams go directly into the filter.

i Special feature when using the delays: If no telegram is received at the input, a configured delay time (time > 0) acts like an automatic cyclic trigger of the filter. The most recently received input status is then forwarded to the filter automatically and repeatedly after the delay has elapsed. This then works according to its configuration and forwards the result to the output of the disabling element. Consequently, the output then also transmits telegrams depending on the transmission criteria set. If the cyclical transmission of the output is not desired due to the automatic triggering of the filter, the transmission criterion should be set to "only transmit if the output changes".

If no delay is provided, the filter is only triggered automatically via the received telegrams and thus not automatically.

i After bus voltage return or after an ETS programming operation, the delays are triggered automatically.

The filter is set by the parameter "Filter function" according to the following table.

Filter function	Result
ON -> ON / OFF -> OFF	Input telegrams are forwarded to the output unchanged. Filter deactivated.
ON -> --- / OFF -> OFF	ON telegrams are filtered and not forwarded to the output. OFF telegrams are forwarded to the output unchanged.

Filter function	Result
ON -> ON / OFF -> ---	OFF telegrams are filtered and not forwarded to the output. ON telegrams are forwarded to the output unchanged.
ON -> OFF / OFF -> ON	ON telegrams are converted to OFF telegrams and OFF telegrams are converted to ON telegrams and are forwarded to the output.
ON -> --- / OFF -> ON	ON telegrams are filtered and not forwarded to the output. OFF telegrams are converted to ON telegrams and forwarded to the output.
ON -> OFF / OFF -> ---	OFF telegrams are filtered and not forwarded to the output. ON telegrams are converted to OFF telegrams and forwarded to the output.

The disabling element can be deactivated by the disabling object. A deactivated disabling element no longer forwards any input states to the filter and consequently does not convert any new output values (the last value is retained and transmitted cyclically, if necessary). However, the input states are still evaluated (even with effective delays). At the end of a disabling function, the disabling element is enabled again. The disabling element waits for the next telegram at the input or for the next cycle of the configured delay times.

The telegram polarity of the disabling object can be configured.

The transmission behaviour of the disabling element output can be configured.

9.1.4.1 Disabling element parameters

Logic functions -> Logic function...

Time function	no delay Delay only ON telegrams Delay only OFF telegrams Delay ON and OFF telegrams
---------------	--

This parameter defines whether ON or OFF telegrams or both states are evaluated with a delay after reception at the input. If a delay is provided, the delay time can be configured separately for ON and OFF telegrams. If no delay is configured, the input telegrams go directly into the filter.

Delay for ON telegrams Minutes (0...59)	0...59
--	--------

The delay for ON telegrams is configured here. A delay is only effective if the delay time is set to greater than "0". Each ON telegram received at the input re-triggers the delay time.

Special feature when using the delays: If no telegram is received at the input, a configured delay time (time > 0) acts like an automatic cyclic trigger of the filter. The most recently received input status is then forwarded to the filter automatically and repeatedly after the delay has elapsed. This then works according to its configuration and forwards the result to the output of the disabling element. Consequently, the output then also transmits telegrams depending on the transmission criteria set. If the cyclical transmission of the output is not desired due to the automatic triggering of the filter, the transmission criterion should be set to "only transmit if the output changes".

After bus voltage return or after an ETS programming operation, the delays are triggered automatically.

Setting the ON delay time minutes.

Seconds (0...59)	0...10...59
------------------	-------------

Setting the seconds of the ON delay time.

The parameters for the ON delay are only available if the parameter "Time function" is set to "only delay ON telegrams" or "delay ON and OFF telegrams".

Delay for OFF telegrams Minutes (0...59)	0...59
<p>The delay for OFF telegrams is configured here. A delay is only effective if the delay time is set to greater than "0". Each OFF telegram received at the input re-triggers the delay time.</p> <p>Special feature when using the delays: If no telegram is received at the input, a configured delay time (time > 0) acts like an automatic cyclic trigger of the filter. The most recently received input status is then forwarded to the filter automatically and repeatedly after the delay has elapsed. This then works according to its configuration and forwards the result to the output of the disabling element. Consequently, the output then also transmits telegrams depending on the transmission criteria set. If the cyclical transmission of the output is not desired due to the automatic triggering of the filter, the transmission criterion should be set to "only transmit if the output changes".</p> <p>After bus voltage return or after an ETS programming operation, the delays are triggered automatically.</p> <p>Setting the OFF delay time minutes.</p>	
Seconds (0...59)	0...10...59
<p>Setting the OFF delay time seconds.</p> <p>The parameters for the OFF delay are only available if the parameter "Time function" is set to "only delay OFF telegrams" or "delay ON and OFF telegrams".</p>	
Polarity of the disabling object	0 = enabled / 1 = disabled 0 =disabled/ 1 = enabled
<p>This parameter defines the polarity of the disabling object.</p>	

Filter function	ON -> ON / OFF -> OFF ON -> --- / OFF -> OFF ON -> ON / OFF -> --- ON -> OFF / OFF -> ON ON -> --- / OFF -> ON ON -> OFF / OFF -> ---
-----------------	--

This parameter defines the function of the filter.

ON -> ON / OFF -> OFF: Input telegrams are forwarded to the output unchanged. Filter deactivated.

ON -> --- / OFF -> OFF: ON telegrams are filtered and not forwarded to the output. OFF telegrams are forwarded to the output unchanged.

ON -> ON / OFF -> ---: OFF telegrams are filtered and not forwarded to the output. ON telegrams are forwarded to the output unchanged.

ON -> OFF / OFF -> ON: ON telegrams are converted to OFF telegrams and OFF telegrams are converted to ON telegrams and forwarded to the output.

ON -> --- / OFF -> ON: ON telegrams are filtered and not forwarded to the output. OFF telegrams are converted to ON telegrams and forwarded to the output.

ON -> OFF / OFF -> ---: OFF telegrams are filtered and not forwarded to the output. ON telegrams are converted to OFF telegrams and forwarded to the output.

Transmission criteria	always transmit when the input is updated transmit only if the output changes transmit cyclically
-----------------------	---

The transmission behaviour of the output can be configured here.

Always transmit when the input is updated: The output transmits the current object value to the KNX with every telegram that is received at the input. In addition, transmission at the output is repeated if no telegram was received at the input when the delay times were used and the configured time has expired.

Transmit only if the output changes: The output only transmits the current object value if the object value has changed compared to the last transmission process. After bus voltage return or an ETS programming operation, the output always transmits.

Transmit cyclically: With this setting, the output transmits the current object value to the KNX cyclically. After bus voltage return or after an ETS programming operation, the cyclical transmission is only started once the first telegram has been received at the input. If the ON / OFF delay is used, after bus voltage return or after an ETS programming, operation cyclical transmission starts automatically once the delay time has expired. The output also transmits as soon as a new telegram is received at the input. At the same time, the cycle time for cyclical transmission is restarted!

Cycle time hours (0...99)	0...99
---------------------------	--------

During cyclical transmission of the output, this parameter defines the cycle time. Setting the cycle time hours.

Minutes (0...59)	0...5...59
This parameter defines the minutes of the cycle time.	
Seconds (0...59)	0...59
This parameter defines the seconds of the cycle time. The parameters for the cycle time are only visible if "transmission criteria" = "transmit cyclically".	

9.1.4.2 Object list for disabling element

Object no.	Function	Name	Type	DPT	Flag
45, 49, ..., 73	Disabling element Input	Logic... - Input	1-bit	1.002	C, (R), W, -, A
<p>1-bit object as input of a disabling element.</p> <p>This object is only available if the type of logic function is configured to "disabling element".</p>					
Object no.	Function	Name	Type	DPT	Flag
46, 50, ..., 74	Disabling element Disabling function	Logic... - Input	1-bit	1.002	C, (R), W, -, A
<p>1-bit object as disabling input of a disabling element. A disabled disabling element no longer forwards any input states to the filter and consequently does not convert any new output values (the last value is retained and transmitted cyclically, if necessary).</p> <p>The telegram polarity can be configured.</p> <p>This object is only available if the type of logic function is configured to "disabling element".</p>					
Object no.	Function	Name	Type	DPT	Flag
134, 136, ..., 148	Disabling element Output	Logic... - Output	1-bit	1.002	C, R, -, T, A
<p>1-bit object as output of a disabling element.</p> <p>This object is only available if the type of logic function is configured to "disabling element".</p>					

9.1.5 Comparator

The comparator works with an input whose data format can be parameterised, and with a 1-bit output to output the result of the comparison operation. The comparator compares the value received at the input with a configured reference value and evaluates whether the reference is correct (result = true) or not (result = false) according to the specified reference function.

The reference function and the reference value are configured in the ETS.

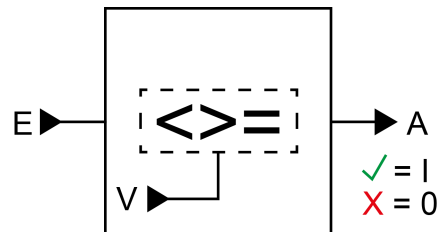

Figure 29: Comparator

The parameter "data format" defines the size and format of input object according to the following table. The output object is preset to 1-bit (DPT 1.002) and outputs the result of the comparison operation (ON = true / OFF = false). The reference value that can be set in the ETS adapts to the input data format.

Data format	KNX DPT
4-bit dimming	3.007
1-byte operating mode switchover	20.102
1-byte scene extension	18.001
1-byte value 0...255	5.010
1-byte brightness value 0...100%	5.001
2-byte value 0...65535	7.001
2-byte value -32768...32767	8.001
2-byte floating-point number	9.0xx
4-byte value -2147483648...2147483647	13.001

The following table shows the possible reference functions (I = input value, R = reference value).

Reference function	Function
equal (I = R)	The comparator output is "ON" (true) if the input is equal to the reference value. Otherwise the output is "OFF" (false).
unequal (I \neq R)	The comparator output is "ON" (true) if the input is unequal to the reference value. If the input value is equal to the reference value, the output is "OFF" (false).
greater than (I > R)	The comparator output is "ON" (true) if the input is greater than the reference value. If the input value is less than or equal to the reference value, the output switches "OFF" (false).

Reference function	Function
greater than or equal to ($I \geq R$)	The comparator output is "ON" (true) if the input is greater than the reference value or equal to the reference value. If the input value is less than the reference value, the output switches "OFF" (false).
less than ($I < R$)	The comparator output is "ON" (true) if the input is less than the reference value. If the input value is greater than or equal to the reference value, the output switches "OFF" (false).
less than or equal to ($I \leq R$)	The comparator output is "ON" (true) if the input is less than the reference value or equal to the reference value. If the input value is greater than the reference value, the output switches "OFF" (false).
Range testing less than ($R1 < I < R2$)	There are two reference values. The comparator output is "ON" (true) if the input is greater than the first reference value or less than the second reference value. If the input value is less than the first reference value or equal to the first reference value or greater than the second reference value or equal to the second reference value, the output switches "OFF" (wrong).
Range testing less than or equal to ($R1 \leq I \leq R2$)	There are two reference values. The comparator output is "ON" (true) if the input is greater than or equal to the first reference value and less than or equal to the second reference value. If the input value is less than the first reference value or greater than the second reference value, the output switches "OFF" (false).

The transmission behaviour of the comparator output can be configured.

9.1.5.1 Comparator parameters

Logic functions -> Logic function...

Data format	4-bit dimming (DPT 3.007) 1-byte operating mode switchover (DPT 20.102) 1-byte scene extension (DPT 18.001) 1-byte value 0...255 (DPT 5.010) 1-byte brightness value 0...100% (DPT 5.001) 2-byte value 0...65535 (DPT 7.001) 2-byte value -32768...32767 (DPT 8.001) 2-byte floating-point number (DPT 9.0xx) 4-byte value -2147483648...2147483647 (DPT 13.001)
<p>This parameter defines the size and format of input object. The output object is preset to 1-bit (DPT 1.002) and outputs the result of the comparison operation (ON = true / OFF = false).</p>	

Reference function	equal ($I = R$) unequal ($I \neq R$) greater than ($I > R$) greater than or equal to ($I \geq R$) less than ($I < R$) less than or equal to ($I \leq R$) Range testing less than ($R1 < I < R2$) Range testing less than or equal to ($R1 \leq I \leq R2$)
<p>The comparator compares the value received (I) at the input with a configured reference value (R) and evaluates whether the comparison is correct (result = true) or not (result = false) according to the specified reference function here.</p> <p>equal ($I = R$): The comparator output is "ON" (true) if the input is equal to the reference value. Otherwise the output is "OFF" (false).</p> <p>unequal ($I \neq R$): The comparator output is "ON" (true) if the input is unequal to the reference value. If the input value is equal to the reference value, the output is "OFF" (false).</p> <p>greater than ($I > R$): The comparator output is "ON" (true) if the input is greater than the reference value. If the input value is less than or equal to the reference value, the output switches "OFF" (false).</p> <p>greater than or equal to ($I \geq R$): The comparator output is "ON" (true) if the input is greater than the reference value or equal to the reference value. If the input value is less than the reference value, the output switches "OFF" (false).</p> <p>less than ($I < R$): The comparator output is "ON" (true) if the input is less than the reference value. If the input value is greater than or equal to the reference value, the output switches "OFF" (false).</p> <p>less than or equal to ($I \leq R$): The comparator output is "ON" (true) if the input is less than the reference value or equal to the reference value. If the input value is greater than the reference value, the output switches "OFF" (false).</p> <p>Range testing less than ($R1 < I < R2$): There are two reference values. The comparator output is "ON" (true) if the input is greater than the first reference value or less than the second reference value. If the input value is less than the first reference value or equal to the first reference value or greater than the second reference value or equal to the second reference value, the output switches "OFF" (wrong).</p> <p>Range testing less than or equal to ($R1 \leq I \leq R2$): There are two reference values. The comparator output is "ON" (true) if the input is greater than or equal to the first reference value and less than or equal to the second reference value. If the input value is less than the first reference value or greater than the second reference value, the output switches "OFF" (false).</p>	

Reference value (V)	<p>dimming darker, stop (0) dimming darker, 100% (1) dimming darker, 50% (2) dimming darker, 25% (3) dimming darker, 12.5% (4) dimming darker, 6% (5) dimming darker, 3% (6) dimming darker, 1.5% (7) increase brightness, stop (8) increase brightness, 100% (9) increase brightness, 50% (10) increase brightness, 25% (11) increase brightness, 12.5% (12) increase brightness, 6% (13) increase brightness, 3% (14) increase brightness, 1.5% (15)</p>
---------------------	--

This parameter specifies the internal reference value (R) for the reference function.
 This parameter is only available if the "data format" is set to "4-bit dimming (DPT 3.007)".

Reference value (V)	<p>Automatic (0) Comfort mode (1) Standby mode (2) Night mode (3) Frost/heat protection (4)</p>
---------------------	--

This parameter specifies the internal reference value (R) for the reference function.
 This parameter is only available if the "data format" is set to "1-byte operating mode switchover (DPT 20.102)".

Reference value (V)	<p>Recall scene 1 (0) Recall scene 2 (1) ... Recall scene 64 (63) Save scene 1 (128) Save scene 2 (129) ... Save scene 64 (191)</p>
---------------------	---

This parameter specifies the internal reference value (R) for the reference function.
 This parameter is only available if the "data format" is set to "1-byte scene extension (DPT 18.001)".

Reference value (V) (0...255)	0...255
This parameter specifies the internal reference value (R) for the reference function. This parameter is only available if the "data format" is set to "1-byte value -0...255 (DPT 5.010)".	
Reference value (V) (0...100%)	0...100
This parameter specifies the internal reference value (R) for the reference function. This parameter is only available if the "data format" is set to "1-byte brightness value 0...100% (DPT 5.001)".	
Reference value (V) (0...65535)	0...65535
This parameter specifies the internal reference value (R) for the reference function. This parameter is only available if the "data format" is set to "2-byte value 0...65535 (DPT 7.001)".	
Reference value (V) (-32768...32767)	-32768...0...32767
This parameter specifies the internal reference value (R) for the reference function. This parameter is only available if the "data format" is set to "2-byte value -32768...32767 (DPT 8.001)".	
Reference value (V) (-671088...670760)	-671088...0...670760
This parameter specifies the internal reference value (R) for the reference function. This parameter is only available if the "data format" is set to "2-byte floating point value (DPT 9.0xx)".	
Reference value (V) (-2147483648...2147483647)	-2147483648...0...2147483647
This parameter specifies the internal reference value (R) for the reference function. This parameter is only available if the "data format" is set to "4-byte value -2147483648...2147483647 (DPT 13.001)".	

- i** Two reference values (R1 & R2) can be configured if the range testing is configured as "reference function". In this case, the setting options are identical.

Transmission criteria	<p>always transmit when the input is updated transmit only if the output changes transmit cyclically</p>
<p>The transmission behaviour of the output can be configured here.</p> <p>Always transmit when the input is updated: The output transmits the current object value to the KNX with every telegram that is received at the input.</p> <p>Transmit only if the output changes: The output only transmits the current object value if the object value has changed compared to the last transmission process. During the first telegram to an input after bus voltage return or after an ETS programming operation, the output always transmits to an input.</p> <p>Transmit cyclically: With this setting, the output transmits the current object value to the KNX cyclically. After bus voltage return or after an ETS programming operation, the cyclical transmission is only started once the first telegram has been received at the input. The output also transmits as soon as a new telegram is received at the input. At the same time, the cycle time for cyclical transmission is restarted!</p>	
Transmission delay for sending the hours result (0...99)	0...99
<p>An optional delay before result transmission (telegram at output) can be configured.</p> <p>With the setting "always transmit when the input is updated": Telegrams at the output are only transmitted after the trigger when the delay has elapsed. The delay time is restarted by each telegram at the input.</p> <p>With the setting "only transmit if the output changes": Telegrams are only sent when the object value changes at the output if the delay has expired. If the logic function is reprocessed by a new telegram at the input within the delay time and the object value changes again, then the delay restarts. If the object value of the output does not change due to new input telegrams, the delay does not restart.</p> <p>This parameter defines the hours of the delay time.</p>	
Minutes (0...59)	0...59
<p>This parameter defines the minutes of the delay time.</p>	
Seconds (0...59)	0...59
<p>This parameter defines the seconds of the delay time.</p> <p>The parameters for the transmission delay are only visible for "Transmission criteria" = "Always transmit when the input is updated" and "Only transmit when the output changes".</p>	
Cycle time hours (0...99)	0...99
<p>During cyclical transmission of the output, this parameter defines the cycle time.</p> <p>Setting the cycle time hours.</p>	
Minutes (0...59)	0... 5 ...59
<p>This parameter defines the minutes of the cycle time.</p>	

Seconds (0...59)	0...59
This parameter defines the seconds of the cycle time. The parameters for the cycle time are only visible if "transmission criteria" = "transmit cyclically".	

9.1.5.2 Object list for Comparator

Object no.	Function	Name	Type	DPT	Flag
77, 78, ..., 84	Comparator Input	Logic... - Input	4-bit	3.007	C, (R), W, -, A

4-bit object as input of a comparator.

This object is only available if the type of logic function is configured to "comparator" and the data format is configured to "4-bit dimming (DPT 3.007)".

Object no.	Function	Name	Type	DPT	Flag
93, 94, ..., 100	Comparator Input	Logic... - Input	1-byte	20.102	C, (R), W, -, A

1-byte object as input of a comparator.

This object is only available if the type of logic function is configured to "comparator" and the data format is configured to "1-byte operating mode switchover (DPT 20.102)".

Object no.	Function	Name	Type	DPT	Flag
93, 94, ..., 100	Comparator Input	Logic... - Input	1-byte	18.001	C, (R), W, -, A

1-byte object as input of a comparator.

This object is only available if the type of logic function is configured to "comparator" and the data format is configured to "1-byte scene extension (DPT 18.001)".

Object no.	Function	Name	Type	DPT	Flag
93, 94, ..., 100	Comparator Input	Logic... - Input	1-byte	5.010	C, (R), W, -, A

1-byte object as input of a comparator.

This object is only available if the type of logic function is configured to "comparator" and the data format is configured to "1-byte value 0...255 (DPT 5.010)".

Object no.	Function	Name	Type	DPT	Flag
93, 94, ..., 100	Comparator Input	Logic... - Input	1-byte	5.001	C, (R), W, -, A

1-byte object as input of a comparator.

This object is only available if the type of logic function is configured to "comparator" and the data format is configured to "1-byte brightness value 0...100% (DPT 5.001)".

Object no.	Function	Name	Type	DPT	Flag
109, 110, ..., 116	Comparator Input	Logic... - Input	2-byte	7.001	C, (R), W, -, A

2-byte object as input of a comparator.

This object is only available if the type of logic function is configured to "comparator" and the data format is configured to "2-byte value 0...65535 (DPT 7.001)".

Object no.	Function	Name	Type	DPT	Flag
109, 110, ..., 116	Comparator Input	Logic... - Input	2-byte	8.001	C, (R), W, -, A

2-byte object as input of a comparator.

This object is only available if the type of logic function is configured to "comparator" and the data format is configured to "2-byte value -32768...32767 (DPT 8.001)".

Object no.	Function	Name	Type	DPT	Flag
109, 110, ..., 116	Comparator Input	Logic... - Input	2-byte	9.xxx	C, (R), W, -, A

2-byte object as input of a comparator.

This object is only available if the type of logic function is configured to "comparator" and the data format is configured to "2-byte floating point value (DPT 9.0xx)".

Object no.	Function	Name	Type	DPT	Flag
125, 126, ..., 132	Comparator Input	Logic... - Input	4-byte	13.001	C, (R), W, -, A

4-byte object as input of a comparator.

This object is only available if the type of logic function is configured to "comparator" and the data format is configured to "4-byte value -2147483648...2147483647 (DPT 13.001)".

Object no.	Function	Name	Type	DPT	Flag
133, 135, ..., 147	Comparator Output	Logic... - Output	1-bit	1.002	C, R, -, T, A

1-bit object as output of a comparator. The output object is preset to 1-bit (DPT 1.002) and outputs the result of the comparison operation (ON = true / OFF = false).

This object is only available if the type of logic function is configured to "comparator".

9.1.6 Limit value switch

The limit value switch works with an input whose data format can be configured, and with a 1-bit output to output the result of the threshold evaluation. The limit value switch compares the value received at the input with two configurable hysteresis threshold values. Once the upper threshold value (H2) is reached or exceeded, the output can transmit a switching telegram (e.g. ON = true). If the value falls below the lower threshold value (H1), the output can transmit another switching telegram (e.g. OFF = false).

The switching telegrams can always be configured in the ETS when the threshold values are exceeded and undershot.

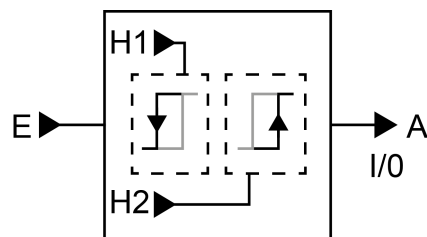

Figure 30: Limit value switch

The two threshold values define a hysteresis. The hysteresis prevents frequent switching back and forth of the output, provided that the input value changes continuously in small intervals. Only when the change in value at the input exceeds the hysteresis as a whole, does the output switch the status.

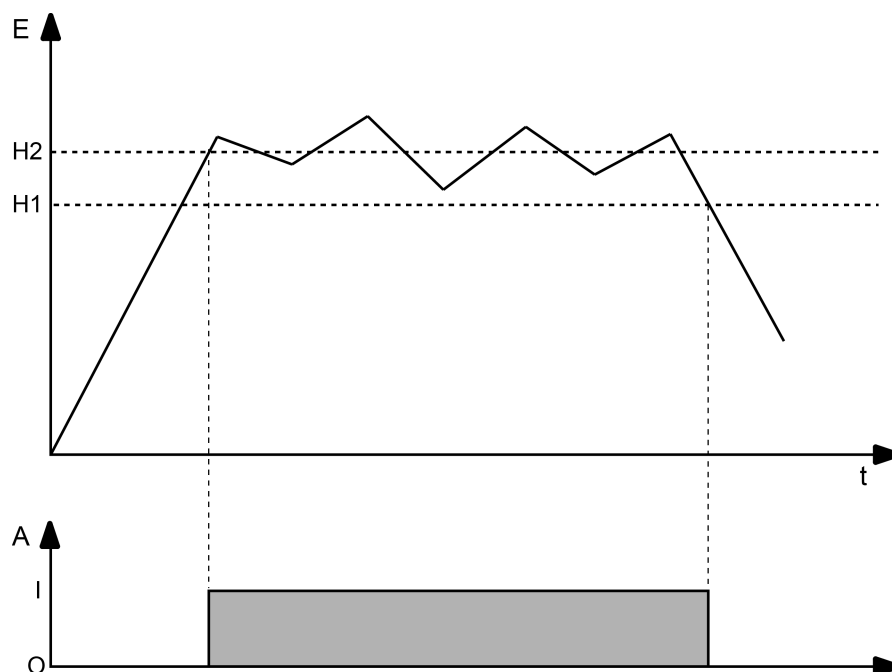

Figure 31: Example of a hysteresis evaluation by upper and lower threshold value

- i** The two threshold values can be freely configured in the ETS. Make sure that the upper threshold value is greater than the lower one!

- i** After bus voltage return or after an ETS programming operation, the output always transmits a telegram when the first value has been received at the input. The telegram depends on whether the value reaches or exceeds the upper threshold (H2) or not. If the value is less than the upper threshold, a telegram is transmitted in accordance with "Telegram upon not reaching the lower threshold". Otherwise the output transmits the "telegram on exceeding the upper threshold value".

The parameter "data format" defines the size and format of input object according to the following table. The output object is preset to 1-bit (DPT 1.002) and outputs the result of the threshold evaluation (ON = true / OFF = false). The threshold values that can be set in the ETS adapt to the input data format.

Data format	KNX DPT
4-bit dimming	3.007
1-byte operating mode switchover	20.102
1-byte scene extension	18.001
1-byte value 0...255	5.010
1-byte brightness value 0...100%	5.001
2-byte value 0...65535	7.001
2-byte value -32768...32767	8.001
2-byte floating-point number	9.0xx
4-byte value -2147483648...2147483647	13.001

The transmission behaviour of the limit value switch can be configured.

9.1.6.1 Limit value switch parameters

Logic functions -> Logic function...

Data format	4-bit dimming (DPT 3.007) 1-byte operating mode switchover (DPT 20.102) 1-byte scene extension (DPT 18.001) 1-byte value 0...255 (DPT 5.010) 1-byte brightness value 0...100% (DPT 5.001) 2-byte value 0...65535 (DPT 7.001) 2-byte value -32768...32767 (DPT 8.001) 2-byte floating-point number (DPT 9.0xx) 4-byte value -2147483648...2147483647 (DPT 13.001)
<p>This parameter defines the size and format of input object. The output object is preset to 1-bit (DPT 1.002) and outputs the result of the threshold evaluation (ON = true / OFF = false).</p>	
Lower threshold value (H1)	dimming darker, stop (0) dimming darker, 100% (1) dimming darker, 50% (2) dimming darker, 25% (3) dimming darker, 12.5% (4) dimming darker, 6% (5) dimming darker, 3% (6) dimming darker, 1.5% (7) increase brightness, stop (8) increase brightness, 100% (9) increase brightness, 50% (10) increase brightness, 25% (11) increase brightness, 12.5% (12) increase brightness, 6% (13) increase brightness, 3% (14) increase brightness, 1.5% (15)
<p>This parameter defines the lower threshold value (H1) of the limit value switch. This parameter is only available if the "data format" is set to "4-bit dimming (DPT 3.007)".</p>	

Lower threshold value (H1)	Automatic (0) Comfort mode (1) Standby mode (2) Night mode (3) Frost/heat protection (4)
This parameter defines the lower threshold value (H1) of the limit value switch. This parameter is only available if the "data format" is set to "1-byte operating mode switchover (DPT 20.102)".	
Lower threshold value (H1)	Recall scene 1 (0) Recall scene 2 (1) ... Recall scene 64 (63) Save scene 1 (128) Save scene 2 (129) ... Save scene 64 (191)
This parameter defines the lower threshold value (H1) of the limit value switch. This parameter is only available if the "data format" is set to "1-byte scene extension (DPT 18.001)".	
Lower threshold value (H1) (0...255)	0...255
This parameter defines the lower threshold value (H1) of the limit value switch. This parameter is only available if the "data format" is set to "1-byte value -0...255 (DPT 5.010)".	
Lower threshold value (H1) (0...100%)	0...100
This parameter defines the lower threshold value (H1) of the limit value switch. This parameter is only available if the "data format" is set to "1-byte brightness value 0...100% (DPT 5.001)".	
Lower threshold value (H1) (0...65535)	0...65535
This parameter defines the lower threshold value (H1) of the limit value switch. This parameter is only available if the "data format" is set to "2-byte value 0...65535 (DPT 7.001)".	

Lower threshold value (H1) (-32768...32767)	-32768...0...32767
<p>This parameter defines the lower threshold value (H1) of the limit value switch. This parameter is only available if the "data format" is set to "2-byte value -32768...32767 (DPT 8.001)".</p>	
Lower threshold value (H1) (-671088...670760)	-671088...0...670760
<p>This parameter defines the lower threshold value (H1) of the limit value switch. This parameter is only available if the "data format" is set to "2-byte floating point value (DPT 9.0xx)".</p>	
Lower threshold value (H1) (-2147483648...2147483647)	-2147483648...0...2147483647
<p>This parameter defines the lower threshold value (H1) of the limit value switch. This parameter is only available if the "data format" is set to "4-byte value -2147483648...2147483647 (DPT 13.001)".</p>	
Upper threshold value (H2)	<p>dimming darker, stop (0) dimming darker, 100% (1) dimming darker, 50% (2) dimming darker, 25% (3) dimming darker, 12.5% (4) dimming darker, 6% (5) dimming darker, 3% (6) dimming darker, 1.5% (7) increase brightness, stop (8) increase brightness, 100% (9) increase brightness, 50% (10) increase brightness, 25% (11) increase brightness, 12.5% (12) increase brightness, 6% (13) increase brightness, 3% (14) increase brightness, 1.5% (15)</p>
<p>This parameter defines the upper threshold value (H2) of the limit value switch. This parameter is only available if the "data format" is set to "4-bit dimming (DPT 3.007)".</p>	

Upper threshold value (H2)	Automatic (0) Comfort mode (1) Standby mode (2) Night mode (3) Frost/heat protection (4)
This parameter defines the upper threshold value (H2) of the limit value switch. This parameter is only available if the "data format" is set to "1-byte operating mode switchover (DPT 20.102)".	
Upper threshold value (H2)	Recall scene 1 (0) Recall scene 2 (1) ... Recall scene 64 (63) Save scene 1 (128) Save scene 2 (129) ... Save scene 64 (191)
This parameter defines the upper threshold value (H2) of the limit value switch. This parameter is only available if the "data format" is set to "1-byte scene extension (DPT 18.001)".	
Upper threshold value (H2) (0...255)	0...255
This parameter defines the upper threshold value (H2) of the limit value switch. This parameter is only available if the "data format" is set to "1-byte value -0...255 (DPT 5.010)".	
Upper threshold value (H2) (0...100%)	0...100
This parameter defines the upper threshold value (H2) of the limit value switch. This parameter is only available if the "data format" is set to "1-byte brightness value 0...100% (DPT 5.001)".	
Upper threshold value (H2) (0...65535)	0...65535
This parameter defines the upper threshold value (H2) of the limit value switch. This parameter is only available if the "data format" is set to "2-byte value 0...65535 (DPT 7.001)".	

Upper threshold value (H2) (-32768...32767)	-32768...0...32767
<p>This parameter defines the upper threshold value (H2) of the limit value switch.</p> <p>This parameter is only available if the "data format" is set to "2-byte value -32768...32767 (DPT 8.001)".</p>	
Upper threshold value (H2) (-671088...670760)	-671088...0...670760
<p>This parameter defines the upper threshold value (H2) of the limit value switch.</p> <p>This parameter is only available if the "data format" is set to "2-byte floating point value (DPT 9.0xx)".</p>	
Upper threshold value (H2) (-2147483648...2147483647)	-2147483648...0...2147483647
<p>This parameter defines the upper threshold value (H2) of the limit value switch.</p> <p>This parameter is only available if the "data format" is set to "4-byte value -2147483648...2147483647 (DPT 13.001)".</p>	
Telegram on reaching or exceeding the upper threshold value	ON telegram OFF telegram
<p>The telegram of the output upon reaching or exceeding the upper threshold can be configured here.</p>	
Telegram on falling below the lower threshold value	ON telegram OFF telegram
<p>The telegram of the output upon not reaching the lower threshold can be configured here.</p>	
Transmission criteria	always transmit when the input is updated transmit only if the output changes transmit cyclically
<p>The transmission behaviour of the output can be configured here.</p> <p>Always transmit when the input is updated: The output transmits the current object value to the KNX with every telegram that is received at the input.</p> <p>Transmit only if the output changes: The output only transmits the current object value if the object value has changed compared to the last transmission process. During the first telegram to an input after bus voltage return or after an ETS programming operation, the output always transmits to an input.</p> <p>Transmit cyclically: With this setting, the output transmits the current object value to the KNX cyclically. After bus voltage return or after an ETS programming operation, the cyclical transmission is only started once the first telegram has been received at the input. The output also transmits as soon as a new telegram is received at the input. At the same time, the cycle time for cyclical transmission is restarted!</p>	

Transmission delay for sending the hours result (0...99)	0...99
<p>An optional delay before result transmission (telegram at output) can be configured.</p> <p>With the setting "always transmit when the input is updated": Telegrams at the output are only transmitted after the trigger when the delay has elapsed. The delay time is restarted by each telegram at the input.</p> <p>With the setting "only transmit if the output changes": Telegrams are only sent when the object value changes at the output if the delay has expired. If the logic function is reprocessed by a new telegram at the input within the delay time and the object value changes again, then the delay restarts. If the object value of the output does not change due to new input telegrams, the delay does not restart.</p> <p>This parameter defines the hours of the delay time.</p>	
Minutes (0...59)	0...59
<p>This parameter defines the minutes of the delay time.</p>	
Seconds (0...59)	0...59
<p>This parameter defines the seconds of the delay time.</p> <p>The parameters for the transmission delay are only visible for "Transmission criteria" = "Always transmit when the input is updated" and "Only transmit when the output changes".</p>	
Cycle time hours (0...99)	0...99
<p>During cyclical transmission of the output, this parameter defines the cycle time.</p> <p>Setting the cycle time hours.</p>	
Minutes (0...59)	0...5...59
<p>This parameter defines the minutes of the cycle time.</p>	
Seconds (0...59)	0...59
<p>This parameter defines the seconds of the cycle time.</p> <p>The parameters for the cycle time are only visible if "transmission criteria" = "transmit cyclically".</p>	

9.1.6.2 Object list for limit value switch

Object no.	Function	Name	Type	DPT	Flag
77, 78, ..., 84	Limit value switch Input	Logic... - Input	4-bit	3.007	C, (R), W, -, A

4-bit object as input of a limit value switch.

This object is only available if the type of logic function is configured to "limit value switch" and the data format is configured to "4-bit dimming (DPT 3.007)".

Object no.	Function	Name	Type	DPT	Flag
93, 94, ..., 100	Limit value switch Input	Logic... - Input	1-byte	20.102	C, (R), W, -, A

1-byte object as input of a limit value switch.

This object is only available if the type of logic function is configured to "limit value switch" and the data format is configured to "1-byte operating mode switchover (DPT 20.102)".

Object no.	Function	Name	Type	DPT	Flag
93, 94, ..., 100	Limit value switch Input	Logic... - Input	1-byte	18.001	C, (R), W, -, A

1-byte object as input of a limit value switch.

This object is only available if the type of logic function is configured to "limit value switch" and the data format is configured to "1-byte scene extension (DPT 18.001)".

Object no.	Function	Name	Type	DPT	Flag
93, 94, ..., 100	Limit value switch Input	Logic... - Input	1-byte	5.010	C, (R), W, -, A

1-byte object as input of a limit value switch.

This object is only available if the type of logic function is configured to "limit value switch" and the data format is configured to "1-byte value 0...255 (DPT 5.010)".

Object no.	Function	Name	Type	DPT	Flag
93, 94, ..., 100	Limit value switch Input	Logic... - Input	1-byte	5.001	C, (R), W, -, A

1-byte object as input of a limit value switch.

This object is only available if the type of logic function is configured to "limit value switch" and the data format is configured to "1-byte brightness value 0...100% (DPT 5.001)".

Object no.	Function	Name	Type	DPT	Flag
109, 110, ..., 116	Limit value switch Input	Logic... - Input	2-byte	7.001	C, (R), W, -, A

2-byte object as input of a limit value switch.

This object is only available if the type of logic function is configured to "limit value switch" and the data format is configured to "2-byte value 0...65535 (DPT 7.001)".

Object no.	Function	Name	Type	DPT	Flag
109, 110, ..., 116	Limit value switch Input	Logic... - Input	2-byte	8.001	C, (R), W, -, A

2-byte object as input of a limit value switch.

This object is only available if the type of logic function is configured to "limit value switch" and the data format is configured to "2-byte value -32768...32767 (DPT 8.001)".

Object no.	Function	Name	Type	DPT	Flag
109, 110, ..., 116	Limit value switch Input	Logic... - Input	2-byte	9.xxx	C, (R), W, -, A

2-byte object as input of a limit value switch.

This object is only available if the type of logic function is configured to "limit value switch" and the data format is configured to "2-byte floating point value (DPT 9.0xx)".

Object no.	Function	Name	Type	DPT	Flag
125, 126, ..., 132	Limit value switch Input	Logic... - Input	4-byte	13.001	C, (R), W, -, A

4-byte object as input of a limit value switch.

This object is only available if the type of logic function is configured to "limit value switch" and the data format is configured to "4-byte value -2147483648...2147483647 (DPT 13.001)".

Object no.	Function	Name	Type	DPT	Flag
133, 135, ..., 147	Limit value switch Output	Logic... - Output	1-bit	1.002	C, R, -, T, A

1-bit object as output of a limit value switch. The output object is preset to 1-bit (DPT 1.002) and outputs the result of the threshold evaluation (ON = true / OFF = false).

This object is only available if the type of logic function is configured to "limit value switch".

Gira
Giersiepen GmbH & Co. KG
Elektro-Installations-
Systeme

Industriegebiet Mermbach
Dahlienstraße
42477 Radevormwald

Postfach 12 20
42461 Radevormwald

Deutschland

Tel +49(0)21 95 - 602-0
Fax +49(0)21 95 - 602-191

www.gira.de
info@gira.de