

Universal LED dimming insert Komfort 2-gang

Order no.: 5402 00

Operating instructions**1 Safety instructions**

Electrical devices may only be mounted and connected by electrically skilled persons.

Serious injuries, fire or property damage possible. Please read and follow manual fully.

Danger of electric shock. Always disconnect before carrying out work on the device or load.

Danger of electric shock. Device is not suitable for disconnection from supply voltage. The load is not electrically isolated from the mains even when the device is switched off.

Risk of destruction if the set operating mode and load type do not match. Set correct operating mode when connecting or exchanging the load.

Fire hazard. For operation with inductive transformers, each transformer must be fused on the primary side in accordance with the manufacturer's instructions. Only safety transformers according to EN 61558-2-6 may be used.

These instructions are an integral part of the product, and must remain with the end customer.

2 Intended use

- Switching and dimming of lighting
- Mounting in appliance box according to DIN 49073
- Operation with suitable cover

3 Product characteristics

- Two independent outputs for two light groups
- Asymmetric load distribution possible
- Device works according to the leading edge phase control or trailing edge phase control principle
- Automatic or manual setting of the dimming principle suitable for the load
- Display of the set operating mode by means LED
- Operation without neutral conductor possible
- Switch-on via bulb-preserving soft start
- Switch on with last saved brightness or saved switch-on brightness
- Switch-on brightness can be saved permanently
- Minimum brightness can be saved permanently
- Connection of extensions possible
- Electronic short-circuit protection with permanent switch-off after 7 seconds at the latest
- Electronic over-temperature protection

i Power extension possible by means of power boosters.

4 Operation

These instructions describe operation with a series button cover. Operation using 3-wire extension with series button cover essentially corresponds to operation on the main device. 3-wire extension with single button cover and rotary dimmer extension only operate output **a1**, 2-wire extension with button cover or push-button for simultaneous operation of both outputs.

i Both outputs are always operated simultaneously with a single button cover.

- Left: operation of output **a1**.
- Right: operation of output **a2**.

Switch light

- Press the button cover briefly: Light switches on or off.
- i** 3-wire extension: Press top to switch on, press bottom to switch off.

Adjust the brightness

Light is switched on.

- Long press on button cover at the top.
The light gets brighter up to maximum brightness.
- Long press on button cover at the bottom.
Light gets darker to minimum brightness.

Switch light on with minimum brightness

- Long press on button cover at the bottom.
Light switches on at minimum brightness.
- Long press on button cover at the top or push-button.
Light switches on at minimum brightness and gets brighter.

Save switch-on brightness

In the state as supplied, the switch-on brightness is set to maximum brightness.

- Adjust the brightness.
- Press the button cover over entire surface for longer than 4 seconds.
Switch-on brightness is saved. For confirmation, the light is switched off briefly and switched on again.

Delete switch-on brightness

- Press the button cover briefly: Light switches on at the saved switch-on brightness.
- Press the button cover over entire surface for longer than 4 seconds.
The switch-on brightness is deleted. For confirmation, the light is switched off briefly and switched on again. Switching on takes place at the last brightness value set.

Operation via push-button as extension

Both outputs are operated simultaneously.

- Press the push-button briefly: Light switches on or off.
- Long press on the push-button: Adjust the brightness. The dimming direction is changed with each new long actuation.

i Saving or deleting the switch-on brightness is not possible.

5 Information for electrically skilled persons**DANGER!**

Mortal danger of electric shock.
Disconnect the device. Cover up live parts.

Fitting and electrical connection**CAUTION!**

Device fault if both outputs are connected to a common load.
Do not connect outputs to a common load. For power extension use power boosters

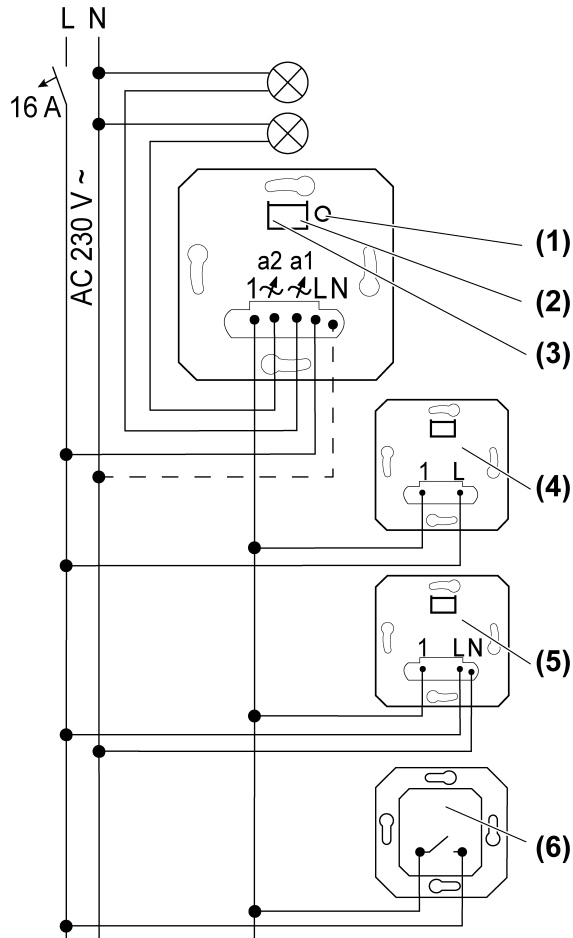

Figure 1: Connection diagram with optional extensions

- (1) **Dimming mode** button
- (2) LED display output 2
- (3) LED display output 1
- (4) 2-wire extension
- (5) 3-wire, rotary dimmer extension
- (6) Push-button, NO contact

i Connect 600 W LED lamps or compact fluorescent lamps at most per 16 A circuit breaker. When connecting transformers, observe the data of the transformer manufacturer.

i Our dimmers take into account the different electronic characteristics of most LED lamps found on the market. However, it cannot be guaranteed that in individual cases the desired results may not be achieved.

Output a1 must be ready for operation, otherwise the dimmer will not function.

Lit push-buttons must have a separate N terminal.

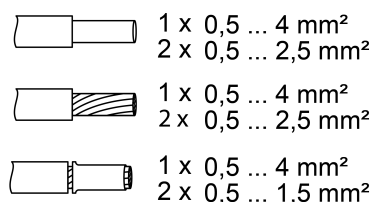

Figure 2: Clampable conductor cross-section

- i** The light for both outputs can be switched by briefly pressing the Dimming mode button (switching states: **a1** on **a2** off, **a1** off **a2** on, **a1** and **a2** on, **a1** and **a2** off).

Reset the overheating protection / short-circuit protection

Disconnect the dimmer from the mains supply.

Operating mode: Universal, R,L,C,LED (factory setting)

- Automatic calibration to the load, dimming principle, trailing edge phase control, leading edge phase control or LED leading edge phase control
- Incandescent lamps, HV halogen lamps, dimmable HV-LED or compact fluorescent lamps, dimmable electronic or inductive transformers for halogen or LED lamps.

Operating mode: LED trailing edge phase control, LED

- i** The connection of inductive transformers is not permitted.
- Incandescent lamps, HV halogen lamps, electronic transformers for halogen or LED lamps that can be dimmed according to the trailing edge phase control principle, HV-LED or compact fluorescent lamps that can be dimmed according to the trailing edge phase control principle.

Operating mode: LED leading edge phase control, LED

- i** The connection of inductive transformers is not permitted.
- Incandescent lamps, HV halogen lamps, electronic transformers for halogen or LED lamps that can be dimmed according to the leading edge phase control principle, HV-LED or compact fluorescent lamps that can be dimmed according to the leading edge phase control principle.

Setting operating mode and minimum brightness

The operating mode and minimum brightness can be individually set for each output.

- Press the **Dimming mode** button (1) for longer than 4 seconds, until the LEDs (2) and (3) light up (Figure 1).



LED	Dimm-Mode
GN (grün, green)	R,L,C,LED
RD (rot, red)	LED 
BU (blau, blue)	LED 

Figure 3: Assignment of LED colour to dimming principle

- Keep briefly pressing the **Dimming mode** button (1) until the necessary operating mode is selected.
LED (2) or (3) lights up in the colour of the selected operating mode (Figure 3).
- Press the **Dimming mode** button (1) for longer than 1 second and keep it pressed.
LED (2) or (3) flashes. Light switches on at the lowest brightness and slowly becomes brighter.
- i** When changing the operating mode to universal, the calibration to the load is first performed. Keep the Dimming mode (1) button pressed.
- i** In the lowest dimming position, a lamp light must be visible.
- Once the desired minimum brightness is reached, release the **Dimming mode** button (1).
LED (2) or (3) lights up, operating mode and minimum brightness are set.
- Optionally change the minimum brightness again: Press the **Dimming mode** button (1) for longer than 1 second.
- Save the settings: Press the **Dimming mode** button (1) for less than 1 second or do not press for 30 seconds.

LED (2) or (3) goes out.

6 Technical data

Rated voltage	AC 230 V~
Mains frequency	50 / 60 Hz
Standby load depending on the cover	approx. 0.1 ... 0.5 W
Power loss	approx. 4 W
Ambient temperature	-5 ... +45 °C
Connected load per output at 25°C (Figure 4)	



			
W 20 ... 210	VA 20 ... 210	W 3 ... 50	W/VA 20 ... 50

Figure 4: Connected load per output

- i** Operating mode **LED** : Max. connected load for HV-LED lamps typ. 3 ... 100 W, electronic transformers with LV-LED typ. 20 ... 100 W.

Mixed load per output

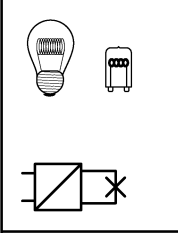
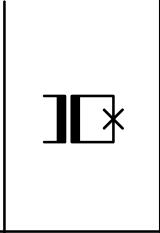
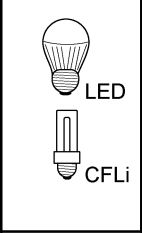
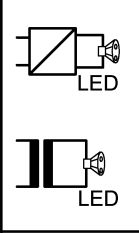
ohmic-capacitive	20 ... 210 W
capacitive-inductive	not permitted
ohmic-inductive	20 ... 210 VA
Ohmic and HV LED	typ. 3 ... 50 W
Ohmic and compact fl lamp.	typ. 3 ... 50 W

- i** Power specifications including transformer dissipation.
- i** Operate inductive transformers with at least 85% nominal load.
- i** Ohmic-inductive mixed load: maximum 50 % proportion of ohmic load. Otherwise, an incorrect measurement is possible.
- i** Operation without neutral conductor: Minimum load 50 W. Does not apply to loads with HV-LED and compact fluorescent lamps.

Power reduction

per 5°C in excess of 25°C	-10%
when installed in wooden or dry construction walls	-15%
when installed in multiple combinations	-20%

Power boosters

see power booster instructions

Number of extension units

2-wire, push-button	unlimited
3-wire, rotary dimmer extension	10
Total length of extension unit cable	max. 100 m
Total length power cable	max. 100 m

7 Troubleshooting

Dimmer has no function

Cause: output **a1** is not ready for operation.

Check load on output **a1**.

Connected LED lamps or compact fluorescent lamps switch off in the lowest dimming position or flicker

Cause: The set minimum brightness is too low.

Increase minimum brightness.

Connected lamps do not switch on in the lowest dimming position or only after a delay

Cause: The set minimum brightness is too low.

Increase minimum brightness.

Connected LED lamps or compact fluorescent lamps flicker or buzz, no correct dimming possible, device buzzes

Cause 1: Lamps are not dimmable.

Check manufacturer's instructions.

Exchange lamps for another type.

Cause 2: Operating mode (dimming principle) and lamps do not optimally match.

Check operation in another operating mode, reduce connected load as well if necessary.

Set the operating mode manually.

Exchange lamps for another type.

Cause 3: Dimmer is connected without neutral conductor.

Connect neutral conductor if possible, otherwise exchange lamp for another type.

Connected LED lamps or compact fluorescent lamps in the lowest dimming position are too bright; dimming range is too small

Cause 1: The set minimum brightness is too high.

Reduce minimum brightness.

Cause 2: Operating mode (dimming principle) does not optimally match the connected HV-LED lamps.

Check operation in another operating mode, reduce connected load as well if necessary.

Set the operating mode manually.

Exchange HV-LED lamps for another type.

The dimmer switches the load off briefly and then on again.

Cause: short-circuit protection has tripped but now there is no longer a fault.

The dimmer has switched off and the load cannot be switched on again

Cause 1: overheating protection has tripped.

Disconnect dimmer from mains by switching off circuit breaker.

LED trailing edge phase control: Reduce the connected load. Exchange lamps for another type.

LED leading edge phase control: Reduce the connected load. Check operation in the LED trailing edge phase control setting. Exchange lamps for another type.

Let dimmer cool down for at least 15 minutes.

Switch circuit breakers and dimmer on again.

Cause 2: Surge protection has triggered.

LED trailing edge phase control: Check operation in the LED leading edge phase control setting, reduce connected load as well if necessary.

Exchange lamps for another type.

Cause 3: short-circuit protection has tripped.

Disconnect dimmer from mains by switching off circuit breaker.

Eliminate short-circuit.

Switch circuit breakers and dimmer on again.

i Short-circuit protection is not based on a conventional fuse, no metallic separation of the operational current.

Cause 4: load failure.

Check load, replace light bulb. For inductive transformers, check primary fuse.

LED lamp is dimly lit when dimmer is switched off

Cause: LED lamp is not optimally suited for this dimmer.

Use a compensation module, see accessories.

Use another type of LED lamp or an LED lamp of another manufacturer.

8 Accessories

Operating top unit 2-gang

Order no. 5362 ..

Operating top unit

Order no. 5360 .., 5361 ..

Compensation module LED

Order no. 2375 00

9 Warranty

The warranty is provided in accordance with statutory requirements via the specialist trade.

Please submit or send faulty devices postage paid together with an error description to your responsible salesperson (specialist trade/installation company/electrical specialist trade). They will forward the devices to the Gira Service Center.

Gira
Giersiepen GmbH & Co. KG
 Elektro-Installations-
 Systeme

Industriegebiet Mermbach
 Dahlienstraße
 42477 Radevormwald

Postfach 12 20
 42461 Radevormwald

Deutschland

Tel +49(0)21 95 - 602-0
 Fax +49(0)21 95 - 602-191

www.gira.de
 info@gira.de