

**Wireless switching/momentary-contact actuator, 8-gang / blinds  
actuator, 4-gang**

Order No. : 5435 00

**Operating instructions****1 Safety instructions**

Electrical devices may only be mounted and connected by electrically skilled persons.

Serious injuries, fire or property damage possible. Please read and follow manual fully.

**Danger of electric shock. Always disconnect before carrying out work on the device or load. In so doing, take all the circuit breakers into account, which support dangerous voltages to the device and or load.**

**Danger of electric shock. Device is not suitable for disconnection from supply voltage.**

**Do not connect any three-phase motors. Device can be damaged.**

**Danger of electric shock. During installation and cable routing, comply with the regulations and standards which apply for SELV circuits.**

**Danger of electric shock on the SELV/PELV installation. Do not connect loads for mains voltage and SELV/PELV together on a single switch actuator.**

**For parallel connection of several motors to an output it is essential to observe the corresponding instructions of the manufacturers, and to use a cut-off relay if necessary. The motors may be destroyed.**

**Use only venetian blind motors with mechanical or electronic limit switches. Check the limit switches for correct adjustment. Observe the specifications of the motor manufacturers. Device can be damaged.**

**Fire hazard! Operation exclusively with the power supplies listed under accessories**

**These instructions are an integral part of the product, and must remain with the end customer.**

**2 Device components**

Figure 1

(1) Load connection **A1...A8**(2) Operating mode switch for outputs **A1+A5, A2+A6, A3+A7, A4+A8**

- (3) Button **Prog A1...A8**
- (4) Status LED **A1...A8**
- (5) **Teach** Switch for commissioning in the operating mode Venetian blind/rolling shutter
- (6) Bus line connection

### 3 Function

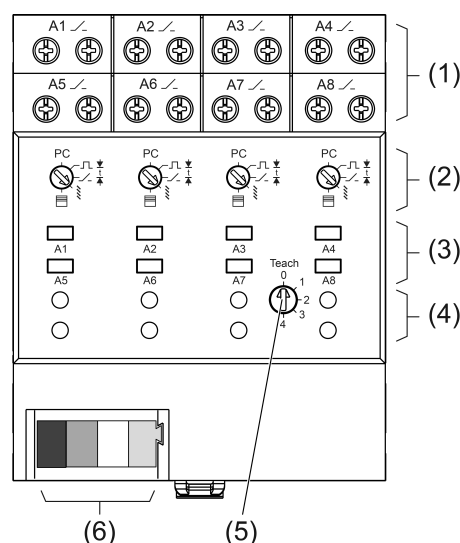
#### Intended use

- Switching of lighting
- Switching of single-phase fan motors
- Controlling electrically driven Venetian blinds, rolling shutters and awnings
- Operation with suitable eNet radio transmitters
- Operation with power supply RMD and receiver module RMD cover or eNet server (see accessories) Operation with power supply RMD and receiver module RMD cover or eNet server (see accessories)
- Installation in distribution boxes on DIN rail according to EN 60715

#### Product characteristics

- Operating mode switch for switch-over of switching actuator, push-button actuator, blind actuator, shutter actuator or configuration via eNet server
- Status feedback to radio transmitter
- Scene operation possible
- Outputs switchable with **Prog** button
- Status indicator of the outputs via LED

#### Switching operation:

- Switch-on telegram: Device switches on
- Switch-off telegram: Device switches off

#### Push-button operation:

- Relay contact remains closed as long as ON or OFF telegrams are being received
- The maximum switch-on time is 60 seconds

#### Operating mode Venetian blind/rolling shutter

- Positioning of the Venetian blind and slats via scene recall
- Position for sun protection and twilight
- Blind/shutter running time can be saved
- Slat change-over time can be saved
- Fabric-stretching for awnings

#### Can be set with eNet server in switching/push-button operation:

- Operating mode for each output can be set separately
- Flash function
- Run-on time
- Switch-on delay / switch-off delay
- Operation as NO or NC contacts
- Switch-off warning
- Minimum switching repeat time
- Operation locks
- Continuous on, Continuous off

#### Can be set in the operating mode Venetian blind/rolling shutter with eNet server:

- Change-over-time for direction change
- Running direction invertible
- Operation locks
- Position for sun protection, twilight, lock-out protection and wind alarm

#### Supplementary functions with eNet Server:

- Fully encrypted radio transmission (AES-CCM) from eNet Server software version 2.0
- Update of the device software
- Reading of error memory

### Behaviour in case of bus voltage failure and return

If the bus voltage fails, the actuator switches off. The response to bus voltage return can be parameterised with the eNet server.

Default setting operating mode Venetian blind/rolling shutter: no action.

Switching operation/bush-button operation default setting: Off.

## 4 Operation

**i** When operating with the eNet Server, operation and signalling could vary from what is described here.

### Operation with radio transmitters

Operation is with radio transmitters, please observe the radio transmitter instructions.

### Operation with Prog button in switching or push-button operation

- Press button **Prog** (3) briefly.  
The light switches on or off.  
Status LED **A1..A8** (4) lights up: output is switched on.  
Status LED **A1..A8** off: output is switched off.

### Operation with Prog button in the operating mode Venetian blind/rolling shutter

In this operating mode, two neighbouring outputs are combined respectively into a single venetian blind output. Both **Prog** buttons have the same function.

- Press **Prog** button briefly.  
A moving blind/shutter is stopped and a stationary blind/shutter is briefly activated, e.g. for slat change-over.  
The control direction is changed when the button is pressed again.
- Press the **Prog** button for longer than one second but shorter than four seconds.  
The motor moves to the end position.  
The control direction is changed when the button is pressed again.  
The upper status LED indicates the upward movement and the lower status LED indicates the downward movement.

## 5 Information for electrically skilled persons

### 5.1 Fitting and electrical connection



#### **DANGER!**

**Electrical shock when live parts are touched.**

**Electrical shocks can be fatal.**

**Before working on the device, disconnect the power supply and cover up live parts in the working environment.**

#### Fitting the device

- Mount device on DIN rail. Output terminals must be at the top.

**Connect bus line**

Figure 2: Connection diagram of bus line

Labelling / Colour	Connection
DC- / GY dark grey	Power supply -
DC+ / RD red	Power supply +
Bus- / WH white	Data cable -
Bus+ / YE yellow	Data cable +

As bus line, use e.g. J-Y(St)Y 2x2x0.8

- Connect the device with bus line (Figure 2) to the RMD reception module and power supply (see instructions of RMD reception module and power supply).

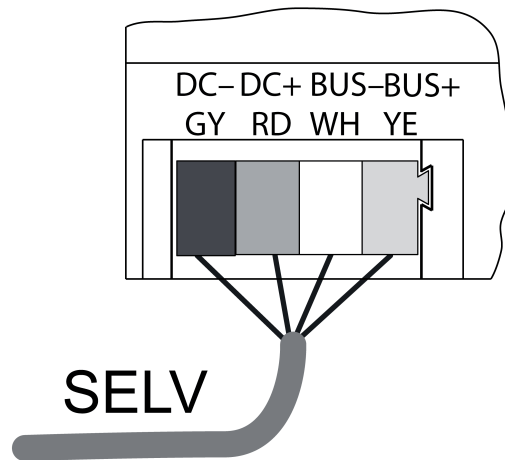
**CAUTION!**

**Overloading the device leads to excessive heating.**

**Damage to the device and the connected cables may result.**

**Do not exceed the maximum current carrying capacity.**

**Load neighbouring outputs only until the sum of their output currents is a max. of 20 A.**

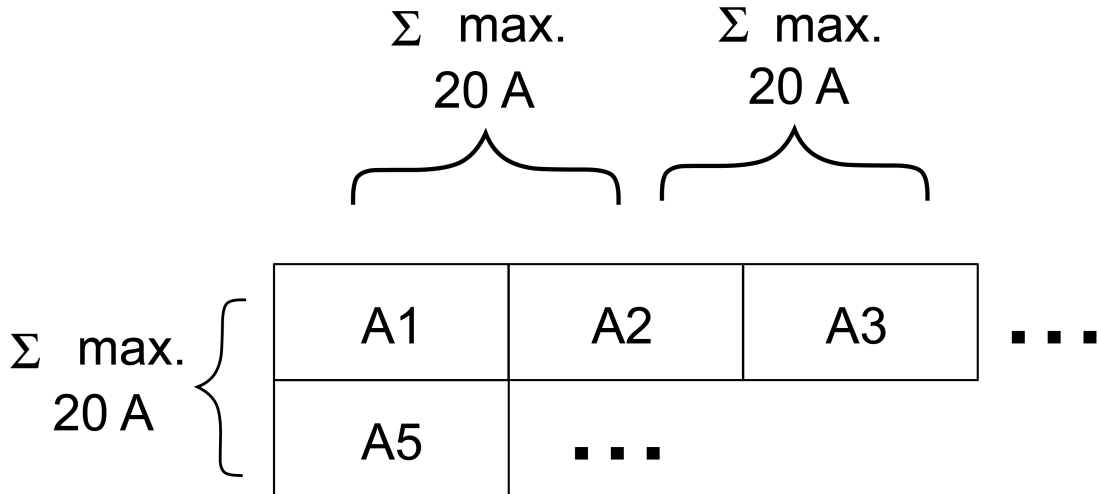

Figure 3: Current carrying capacity of neighbouring outputs

**Connecting loads in switching/push-button operation**

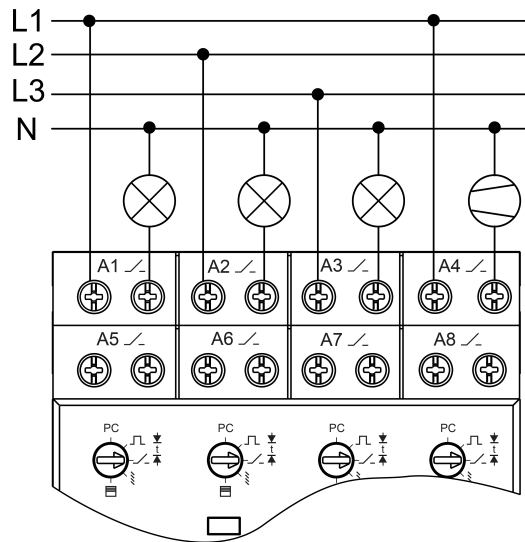

Figure 4: Connection example of switching loads **A1...A4**

- Connect loads as shown in the connection example of switching loads (Figure 4).

**Connecting loads in operating mode Venetian blind/rolling shutter**

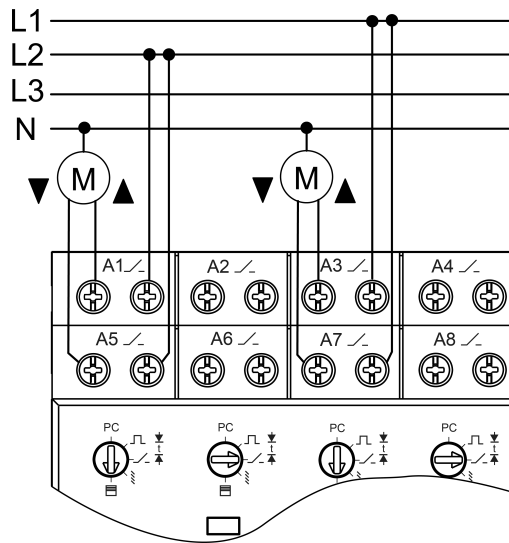

Figure 5: Connection example of Venetian blind loads

- Connect loads as shown in the connection example of Venetian blind loads (Figure 5).

**Presetting the operating mode**



**CAUTION!**

**Danger of destruction from wrong operating mode.**

**Simultaneous current feed in both directions of travel can destroy the device and connected blind motors.**

**Before setting the operating mode, check what loads are connected.**

One operating mode switch applies to two outputs each.

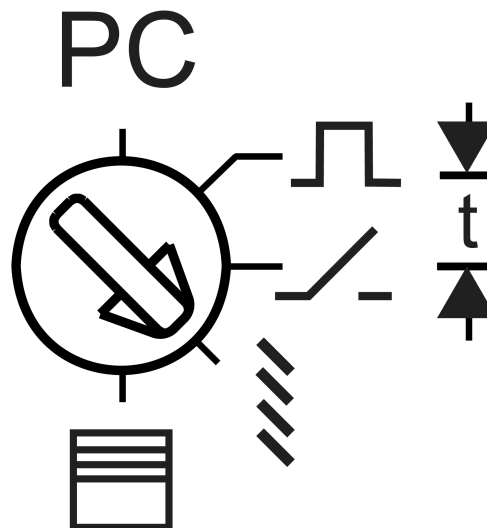







Figure 6: Operating mode switch

Switch position	Function
-----------------	----------

<b>PC</b>	Operating mode and parameter set with eNet server.*)
	Push-button operation
	Switching operation
	Commission - determine running time, activate <b>Teach</b> switch
	Commissioning - determine time for slat change-over time, activate <b>Teach</b> switch
	Blind operating mode
	Operating mode rolling shutter, awning

\*) If the operating mode switch is turned from the position **PC** to another operating mode, the parameters are set to the default setting. The settings made with the eNet Server will be lost.

Mains voltage is switched off.

- Set the operating mode switch.

## 5.2 Commissioning





### **DANGER!**

**Electrical shock when live parts are touched.**



**Electrical shocks can be fatal.**

**During commissioning, cover the parts carrying voltage on radio transmitters and actuators and in their surrounding area.**



-  The actuator can also be commissioned with eNet server as an alternative to the commissioning described here.
-  Prerequisite for scenes and positioning movements is that the moving times of the connected blind/shutter in the actuator are saved.
-  To save the running times of several outputs successively, the **Teach** switch must always be turned back to position **0**.



### **Saving blind/shutter running time for rolling shutters**

The operating mode switch (2) is in the Venetian blind  or rolling shutter  position.

- Set **Teach** switch (5) to output **1, 2, 3** or **4**.
- Turn the operating mode switch to the  **t** position until the blind/shutter reaches the upper end position.
- Turn operating mode switch to the  **t** position.  
The blind/shutter moves downwards.
- When the lower end position is reached, turn the operating mode switch to the  position.  
The running time is saved and the blind/shutter moves to the upper end position.
- Turn back **Teach** switch to **0** position. Otherwise, it will not be possible to operate the output anymore.

### **Saving blind/shutter running time for blind**

The operating mode switch (2) is in the Venetian blind  or rolling shutter  position.

- Set **Teach** switch (5) to output **1, 2, 3** or **4**.
- Turn the operating mode switch to the  **t** position until the blind/shutter reaches the upper end position.
- Turn operating mode switch to the  **t** position.  
The blind/shutter moves downwards.

- When the lower end position is reached, turn the operating mode switch to the **▲ t** position.
- When the slats have been fully changed over, turn the operating mode switch to the **≡** position.  
The running times are saved and the blind/shutter moves to the upper end position.
- Turn back **Teach** switch to **0** position. Otherwise, it will not be possible to operate the output anymore.

### Saving the awning running time

The operating mode switch (2) is in the Venetian blind **≡** or rolling shutter **☐** position.

- Set **Teach** switch (5) to output **1, 2, 3** or **4**.
- Turn the operating mode switch (2) to the **▲ t** position until the blind/shutter reaches the upper end position.
- Turn operating mode switch to the **▼ t** position.
- For awnings without fabric-stretching function: When the extended lower end position is reached, turn the operating mode switch to the **▲ t** position. As soon the fabric is hanging taut, turn the operating mode switch to the **☐** position.
- For awnings with their own fabric-stretching function: When the extended lower end position is reached, turn the operating mode switch to the **☐** position.  
The running times are saved and the blind/shutter moves to the upper end position.
- Turn back **Teach** switch to **0** position. Otherwise, it will not be possible to operate the output anymore.

### Connecting output to radio transmitters

Load is switched off.

- Press button **Prog** (3) for longer than 4 seconds.  
The load switches on.  
The status LED (4) flashes after 4 seconds and the load switches off. The device is in programming mode for approx. 1 minute.
- Switch radio transmitter to programming mode (see radio transmitter instructions).
- Trigger telegram on the radio transmitter.  
The status LED of the corresponding output is illuminated for 5 seconds.  
The output is connected to the radio transmitter. The output and radio transmitter exit the programming mode automatically.
- i** If the status LED of the actuator flashes 3 times at 1-second intervals for approx. 5 seconds, then the programming operation was not successful. All the memory locations in the actuator or radio transmitter are occupied.
- i** In switching operation, All On and All Off buttons of a radio transmitter are connected to the output automatically as soon as the first connection to the radio transmitter takes place.
- i** Scene buttons must be connected separately.

### Disconnecting connection to a radio transmitter

- Carry out the same steps as when connecting (see Connecting output to a radio transmitter).  
The status LED (4) flashes quickly for 5 seconds. The output is disconnected from the radio transmitter. The output and radio transmitter exit the programming mode automatically.
- i** If there several connections or scene buttons for a radio transmitter, all connections must be disconnected individually.
- i** All On and All Off buttons of a radio transmitter are disconnected automatically as soon as the last connection of the corresponding output to the radio transmitter is disconnected. Manual disconnection is not possible.



**Resetting the output to the factory setting**

All connections to radio transmitters are disconnected and parameters are reset to default setting. If the operating mode switch is on **PC**, the rolling shutter operating mode is set.

**i** The connections in the radio transmitters are preserved and must be deleted separately.

Load is switched off.

- Press the **Prog** button for at least 20 seconds.  
The load switches on.  
The status LED flashes after 4 seconds and the load switches off. The status LED flashes faster after 20 seconds.
- Release **Prog** button and press briefly once again within 10 seconds.  
The status LED flashes more slowly for approx. 5 seconds.  
The output is reset to default setting.

**Resetting the device to the factory setting**

- Reset all outputs (see Resetting the output to the default setting).  
All the status LEDs flash as soon as the last output is reset. The device is reset to default setting.

**6 Appendix****6.1 Technical data**

Rated voltage	AC 230 V ~
Mains frequency	50 / 60 Hz
Ambient temperature	-5 ... +45 °C
Switching voltage	AC 250 V ~
Minimum actuation time in operating mode	
Venetian blind	0.1 s
Roller shutter	0.3 s
Running time	1 ... 600 s
Running time default setting	120 sec
Slat adjusting time	0 ... 10 s
Switching current per output for AC 230 V ~	
Ohmic	16 A (AC1)
For switching current >10A connecting cable 2.5mm <sup>2</sup>	
Fluorescent lamps	4 AX
Switching current, adjacent load outputs	Σ 20 A
Current carrying capacity of device	max. 80 A
Minimum switching current AC	100 mA
Contact type	μ
Standby power	max. 0.5 W
Connected load per output	
Motors	1000 W
Incandescent lamps	2300 W
HV halogen lamps	2000 W
Electronic transformers	1500 W
Inductive transformers	1000 VA
HV-LED lamps	typical 500 W
Compact fl lamp.	typical 500 W
Fluorescent lamps, uncompensated	920 VA
Capacitive load	690 VA (560 μF)
Connection of load terminals	
single stranded	1.5 ... 4 mm <sup>2</sup>
Finely stranded without conductor sleeve	0.75 ... 4 mm <sup>2</sup>
Finely stranded with conductor sleeve	0.5 ... 2.5 mm <sup>2</sup>
Fitting width	72 mm / 4 modules
Bus line	
Rated voltage	DC 12 V SELV

Current consumption  
Connection, Bus  
Cable length

60 mA  
device connection terminal  
max. 3 m

## 6.2 Parameter list

The device parameters can be changed with the eNet server:

### Device and channels

Parameters	Setting options, Basic setting	Explanations
Function	Shutter/blind, light, switching, unused Basic setting: Venetian blind	<p><b>Venetian blind</b> The channel is integrated for the "Venetian blind" central function in the <b>eNet SMART HOME app</b>.</p> <p><b>Light</b> The channel is integrated for the "Lighting" central function in the <b>eNet SMART HOME app</b>.</p> <p><b>Switching</b> The channel is not integrated in any central function.</p> <p><b>Unused</b> The channel is not displayed in the <b>eNet SMART HOME app</b> and is disabled for use in the commissioning interface. Setting is always made in pairs (1/5, 2/6, 3/7, 4/8).</p>
"Venetian blind" operating mode	Venetian blind Awning Basic setting: Roller shutter	<p><b>Roller shutter</b> A rolling shutter or an awning is controlled for which the Fabric stretching function is required.</p> <p><b>Venetian blind</b> A Venetian blind is controlled.</p> <p><b>Awning</b> An awning is controlled for which the Fabric stretching function is required.</p>

<p>"Switching" operating mode</p>	<p>Switching operation                  Push-button operation                  Flashing                  Continuous on                  Continuous off                  Basic setting: Switching operation</p>	<p>Switching operation                  After switch-on, the device remains stable in the "On" state, and stable in the "Off" state after switch-off.</p> <p>Push-button operation                  The device switches "On" when any channel button of a radio transmitter is pressed and "Off" when the button is released. It is irrelevant whether the "On" or "Off" channel button is pressed.</p> <p>Flashing                  Switch-on starts flashing and switch-off stops flashing. The default flash frequency is 1 Hz. This frequency is also the maximum flash frequency. The flash frequency can be changed using parameters. The parameter "Switch-off delay" is used for the pulse time and the parameter "Switch-on delay" for the pause time.</p> <p>Continuous on                  The output switches to continuously "On". All operations of radio transmitters and the <b>Prog</b> button are ignored.</p> <p>Continuous off                  The output switches to continuously "Off". All operations of radio transmitters and the <b>Prog</b> button are ignored.</p>
-----------------------------------	--	---

### Advanced device settings

Parameters	Setting options, Basic setting	Explanations
Manual commissioning	On, Off Basic setting: On	Disables manual commissioning for all device channels. In the "Off" setting, the device cannot be reset to the factory setting.

### Channel settings "switching"

Parameters	Setting options, Basic setting	Explanations
------------	--------------------------------	--------------

Switch-on delay	0 s ... 24 h Basic setting: 0 s	The load switches on after a delay. Repeated switch-on commands restart the delay time. If the load has not yet been switched on due to the delay when a switch-off command comes, then the load will remain off. In Flashing operating mode, the pause time is set using this parameter. Comment: The set times apply to operation using radio transmitters. The relay is switched immediately when the <b>Prog</b> button is pressed.
Switch-off delay	0 s ... 24 h Basic setting: 0 s	The load switches off after a delay. Repeated switch-off commands restart the delay time. If the load has not yet been switched off due to the delay when a switch-on command comes, then the load will remain on. In Flashing operating mode, the pulse times are set using this parameter. Comment: The set times apply to operation using radio transmitters. The relay is switched immediately when the <b>Prog</b> button is pressed.
Run-on time	0 s ... 24 h Basic setting: 0 s	As soon as a run-on time has been entered, the actuator will no longer remain on permanently, but only for the length of the run-on time. The run-on time is restarted if actuation is repeated. This parameter is directly connected to the "Manual switch-off of run-on time" parameter. Comment: The set times apply to operation using radio transmitters. The relay is switched immediately when the <b>Prog</b> button is pressed.
Manual switch-off of the run-on time	On, Off Basic setting: Off	Allows manual switch-off of a running run-on time. If the parameter is switched off, then a switch-off command will also switch the actuator on. This parameter is directly connected to the "Run-on time" parameter.

Operating hours	0...65535 Basic setting: Current value	The time is counted during which the load is physically switched on (relay contact closed). This parameter can be reset to "0", for example after exchanging the load. The Reset button is used to reset the meter to "0". The device must be programmed to apply the change.
-----------------	---	---

**Extended channel settings "switching"**

Parameters	Setting options, Basic setting	Explanations
Operating mode	Switching operation Push-button operation Flashing Continuous on Continuous off Basic setting: Switching operation	See Device and channels.
Manual commissioning	On, Off Basic setting: On	Blocks manual commissioning for the device channel. In the "Off" setting, the device cannot be reset to the factory setting.
Local Operation	On, Off Basic setting: On	Blocks the output for operation using the <b>Prog</b> button.
Behaviour on voltage return	On Off Last value Configured brightness Basic setting: Off	Defines the behaviour of the output after voltage return.
Timer behaviour, voltage return	Off Restart Basic setting: Off	Specifies whether the timers for switch-on delay, switch-off delay and run-on time remain off after voltage return or whether they restart. Directly connected to the parameters "Switch-on delay", "Switch-off delay" and "Run-on time".
Behaviour after the end of the disabling function	On Off no change Last value Basic setting: No change	Behaviour of the output when a block is removed.
Manual saving of the scene values	On, Off Basic setting: On	Disables the saving of the current actuator state (On/Off) as scene value in an actuator for a command via a transmitter.

Switch-off warning	On, Off Basic setting: Off	If the switch-off warning is active, the light is not switched off directly. The light goes off 30, 15 and 6 seconds before permanent switch-off. During the switch-off warning, a switch-on telegram effects direct switch-on. It is not possible to terminate the time using a switch-off telegram.
Priority, lock-out protection	0...4 Basic setting: 1	Specifies the priority for recalling and removing a scene of type Lock-out protection for the channel.
Activate lock-out protection switching state	On, Off Basic setting: Off	Defines the behaviour of the output on activating the lock-out protection.
Deactivate lock-out protection switching state	On, Off Basic setting: Off	Defines the behaviour of the output on deactivating the lock-out protection. Only visible when the priority for the lock-out protection is 0.
Priority, restraint	0...4 Basic setting: 2	Specifies the priority for recalling and removing a scene of type Restraint for the channel.
Activate forced operation switching state	On, Off Basic setting: On	Defines the behaviour of the output on activating the forced operation.
Deactivate forced operation switching state	On, Off Basic setting: Off	Defines the behaviour of the output on deactivating the forced operation. Only visible when the priority for the forced operation is 0.
Priority, wind alarm	0...4 Basic setting: 3	Specifies the priority for recalling and removing a scene of type Wind alarm for the channel.
Activate wind alarm switching state	On, Off Basic setting: Off	Defines the behaviour of the output on activating the wind alarm.
Deactivate wind alarm switching state	On, Off Basic setting: Off	Defines the behaviour of the output on deactivating the wind alarm. Only visible when the priority for the wind alarm is 0.
Priority, sun protection	0...4 Basic setting: 0	Specifies the priority for recalling and removing a scene of type Sun protection for the channel.
Activate sun protection switching state	On, Off Basic setting: On	Defines the behaviour of the output on deactivating the sun protection. Only visible when the priority for the sun protection is 0.

Deactivate sun protection switching state	On, Off Basic setting: Off	Defines the behaviour of the output on deactivating the sun protection. Only visible when the priority for the sun protection is 0.
Priority, twilight	0...4 Basic setting: 0	Specifies the priority for recalling and removing a scene of type Twilight for the channel.
Activate twilight switching state	On, Off Basic setting: On	Defines the behaviour of the output on activating the twilight function.
Deactivate twilight switching state	On, Off Basic setting: Off	Defines the behaviour of the output on deactivating the twilight function. Only visible when the priority for the twilight function is 0.
Switch off brightness overshoot	On, Off Basic setting: On	Allows automatic switch-off according to the brightness. If the parameter is On, then the light controller switches off automatically when the brightness setpoint is greatly exceeded. This parameter is not yet active, as a light controller has not yet been implemented.
Switch on brightness undershoot	On, Off Basic setting: Off	Allows automatic switch-on according to the brightness. If the parameter is On, then the light controller switches on automatically when the brightness setpoint is greatly undershot. We recommend only using the parameter in connection with the parameter "Switch-off on brightness overshoot". This parameter is not yet active, as a light controller has not yet been implemented.
Invert switching output	On, Off Basic setting: Off	Inverts the switching output from NO contact function (factory setting) to NC contact function
Minimum switching repeat time	100 ms ... 10 sec Basic setting: 100 ms	Limits the switching speed of the device by increasing the value, in order to protect the load, for example. Only when the set time has elapsed is switching possible again. The last command during the blocking time is executed after a delay. The switching repeat time starts after each switching operation.

**Channel settings "Venetian blind"**

Parameters	Setting options, Basic setting	Explanations
Operating hours up	0...65535 Basic setting: Current value	The time is counted during which the load is physically switched on (relay contact closed). This parameter can be reset to "0", for example after exchanging the load. The Reset button is used to reset the meter to "0". The device must be programmed to apply the change.
Operating hours down	0...65535 Basic setting: Current value	The time is counted during which the load is physically switched on (relay contact closed). This parameter can be reset to "0", for example after exchanging the load. The Reset button is used to reset the meter to "0". The device must be programmed to apply the change.

**Extended channel settings "Venetian blind"**

Parameters	Setting options, Basic setting	Explanations
Operating mode	Roller shutter Venetian blind Awning Basic setting: Roller shutter	See Device and channels.
Manual commissioning	On, Off Basic setting: On	Blocks manual commissioning for the device channel. In the "Off" setting, the device cannot be reset to the factory setting.
Local Operation	On, Off Basic setting: On	Blocks the output for operation using the button.
Running time	1 ... 600 sec Basic setting: 120 s	Absolute time which the blind/shutter requires from the top to the bottom end position. The entry is essential if scene or position movements are to occur.
Slat change-over time Fabric-stretching time	0 ms ... 10 sec 300 ms ... 10 s Basic setting: 0 ms / 300 ms	Absolute time for changing-over Venetian blind slats. The fabric stretching time can also be set here for the Awning operating mode.
Minimum change-over-time	300 ms ... 10 sec Basic setting: 1 s	Minimum interruption time when changing directions. Increasing the minimum change-over time will cause less wear on the motors.



Invert movement direction	On, Off Basic setting: Off	Inverts the activation of the relay outputs. During inverted operation, the relay outputs "Up" and "Down" should be activated in reverse. This is required, for example, for controlling skylights.
Behaviour on voltage return	No change Configured value Basic setting: No change	Defines the behaviour of the output after voltage return. RMD design: Bus voltage return
Configured venetian blind position	0 ... 100 % Basic setting: 0 %	If the value "Configured position" is entered for the parameter "Behaviour after voltage return", then the blind/shutter position set here is approached.
Configured slat position	0 ... 100 % Basic setting: 0 %	If the value "Configured position" is entered for the parameter "Behaviour after voltage return", then the slat position set here is approached.
Behaviour after the end of the disabling function	no change Last value Down up Basic setting: No change	Behaviour of the output when a block is removed.
Manual saving of the scene values	On, Off Basic setting: On	Disables the saving of the current Venetian blind position as scene value in an actuator for a command via a transmitter.
Priority, lock-out protection	0...4 Basic setting: 1	Specifies the priority for recalling and removing a scene of type Lock-out protection for the channel.
Activate lock-out protection blind position	0 ... 100 % Basic setting: 0 %	Defines the behaviour of the output on activating the lock-out protection.
Activate lock-out protection slat position	0 ... 100 % Basic setting: 0 %	Defines the slat position of the output on activating the lock-out protection. Only visible when the Venetian blind operating mode is set.
Deactivate lock-out protection blind position	0 ... 100 % Basic setting: 0 %	Defines the behaviour of the output on deactivating the lock-out protection. Only visible when the priority for the lock-out protection is 0.
Deacitvate lock-out protection slat position	0 ... 100 % Basic setting: 0 %	Defines the behaviour of the output on deactivating the lock-out protection. Only visible when the priority for lock-out protection is 0 and the Venetian blind operating mode is set.

Priority, restraint	0...4 Basic setting: 2	Specifies the priority for recalling and removing a scene of type Restraint for the channel.
Activate force operation blind position	0 ... 100 % Basic setting: 0 %	Defines the behaviour of the output on activating the forced operation.
Recall forced operation slat position	0 ... 100 % Basic setting: 0 %	Defines the slat position of the output on activating forced operation. Only visible when the Venetian blind operating mode is set.
Deactivate force operation blind position	0 ... 100 % Basic setting: 0 %	Defines the behaviour of the output on deactivating the forced operation. Only visible when the priority for the forced operation is 0.
Deactivate forced operation slat position	0 ... 100 % Basic setting: 0 %	Defines the slat position of the output on deactivating forced operation. Only visible when the priority for the forced operation is 0 and the Venetian blind operating mode is set.
Priority, wind alarm	0...4 Basic setting: 3	Specifies the priority for recalling and removing a scene of type Wind alarm for the channel.
Activate wind alarm blind position	0 ... 100 % Basic setting: 0 %	Defines the behaviour of the output on activating the wind alarm.
Recall wind alarm slat position	0 ... 100 % Basic setting: 0 %	Defines the slat position of the output on activating the wind alarm. Only visible when the Venetian blind operating mode is set.
Deactivate wind alarm blind position	0 ... 100 % Basic setting: 0 %	Defines the behaviour of the output on deactivating the wind alarm. Only visible when the priority for the wind alarm is 0.
Deactivate wind alarm slat position	0 ... 100 % Basic setting: 0 %	Defines the slat position of the output on deactivating the wind alarm. Only visible when the priority for the wind alarm is 0 and the Venetian blind operating mode is set.
Priority, sun protection	0...4 Basic setting: 0	Specifies the priority for recalling and removing a scene of type Sun protection for the channel.
Activate sun protection blind position	0 ... 100 % Basic setting: 100 %	Defines the behaviour of the output on activating the sun protection.

Recall sun protection slat position	0 ... 100 % Basic setting: 100 %	Defines the slat position of the output on activating the sun protection. Only visible when the Venetian blind operating mode is set.
Deactivate sun protection blind position	0 ... 100 % Basic setting: 0 %	Defines the behaviour of the output on deactivating the sun protection. Only visible when the priority for the sun protection is 0.
Deactivate sun protection slat position	0 ... 100 % Basic setting: 0 %	Defines the slat position of the output on deactivating the sun protection. Only visible when the priority for the sun protection is 0 and the Venetian blind operating mode is set.
Priority, twilight	0..4 Basic setting: 0	Specifies the priority for recalling and removing a scene of type Twilight for the channel.
Activate twilight blind position	0 ... 100 % Basic setting: 100 %	Defines the behaviour of the output on activating the twilight function.
Activate twilight slat position	0 ... 100 % Basic setting: 100 %	Defines the slat position of the output on activating the twilight function. Only visible when the Venetian blind operating mode is set.
Deactivate twilight blind position	0 ... 100 % Basic setting: 0 %	Defines the behaviour of the output on deactivating the twilight function. Only visible when the priority for the twilight function is 0.
Deactivate twilight slat position	0 ... 100 % Basic setting: 0 %	Defines the slat position of the output on deactivating the twilight function. Only visible when the priority for the twilight function is 0 and the Venetian blind operating mode is set.

**Information window**

During channel selection in the Information window, the following settings can be made or values displayed.

**"Switching"**

Display value	Explanations
Load state	The load can be switched on or off.
Restraint	Display of forced position status.
Operating hours	Display of the operating hours since the last restart in the Settings window <b>Einstellungen</b> .

**"Venetian blind"**

Display value	Explanations
Position value, venetian blind	The position value of the Venetian blind can be changed.
Position value, slat	The position value of the slat can be changed.
Restraint	Display of forced position status.
Lock-out protection	Display of the lock-out protection status
Operating hours UP	Display of the operating hours in the UP direction since the last restart in the Settings window.
Operating hours DOWN	Display of the operating hours in the DOWN direction since the last restart in the Settings window.

**6.3 Troubleshooting****Output switches the load off and cannot be switched on again.**

Cause: Operating mode switch was set to another load type, status LEDs of the overlapping outputs flash.

Operating mode was accidentally adjusted: Reset the original operating mode on the operating mode switch.

Operating mode was intentionally adjusted because a correspondingly different load was connected. Switch bus voltage off and on again, the output assumes the new operating mode.

**An output cannot be operated.**

Cause: **Teach** switch is not in position **0**.

Turn **Teach** switch to **0** position.

**6.4 Accessories**

Power supply 12 V DC / 2 A DRA  
Wireless receiver module  
eNet Server

Order No. 5319 00  
Order No. 5452 00  
Order No. 5301 00

**6.5 Warranty**

The warranty follows about the specialty store in between the legal framework as provided for by law

Please submit or send faulty devices postage paid together with an error description to your responsible salesperson (specialist trade/installation company/electrical specialist trade). They will forward the devices to the Gira Service Center.

**Gira**  
**Giersiepen GmbH & Co. KG**  
Elektro-Installations-  
Systeme

Industriegebiet Mermbach  
Dahlienstraße  
42477 Radevormwald

Postfach 12 20  
42461 Radevormwald

Deutschland

Tel +49(0)21 95 - 602-0  
Fax +49(0)21 95 - 602-191

[www.gira.de](http://www.gira.de)  
[info@gira.de](mailto:info@gira.de)