

# GIRA

New freedom  
with KNX.

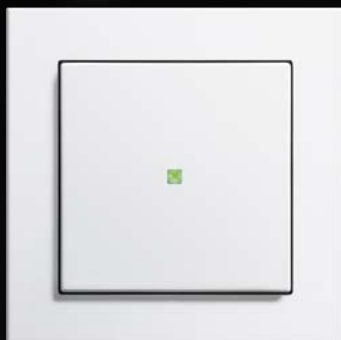

Gira / Smart Home

We are Gira.  
We are the ones with the switches.  
But we're so much more.

Future-oriented.  
Certified.  
Responsible.

We're the guardians, innovators,  
smart home pioneers, developers,  
systems thinkers, KNX partners,  
shapers of the future, patent masters,  
award winners and designers.

But above all, we're the ones  
who listen.  
To you.

Subtle, but smart.  
With distinct focus on quality,  
materials and functions.  
And the driving force of innovation.

In our hearts, we are engineers  
on a mission to inspire.  
With new technologies,  
smart applications, and  
impressive attention to detail.

We will always work our hardest  
to find the best solution for you.  
With service, design and performance  
made in Germany.

Because that is what we stand for.  
And have been standing for since 1905.

04	_____	KNX RF system
08	_____	KNX RF operating top unit
10	_____	Gira X1
12	_____	Smart Home App & KNX RF/TP media coupler
14	_____	Gira KNX RF data interface
16	_____	KNX RF operating devices
18	_____	KNX TP
20	_____	KNX actuators
22	_____	Gira pushbutton sensor 4
24	_____	Service & Gira Academy
26	_____	Company

# Use the new freedom that KNX RF offers to make existing buildings smart.

The future is smart and is being realised in new buildings via KNX. In existing buildings, laying the BUS cable has made this very costly and time-consuming until now. The solution: Gira's radio-operated KNX RF portfolio.

KNX RF can also be easily installed in renovations and refurbishments without having to pry open walls, as the existing wiring can be reused for the 230 V installation. KNX com-

munication between the individual components takes place via the robust and reliable KNX standard. Existing KNX systems can also be easily extended to include KNX RF.

Find out more about the new KNX RF portfolio from Gira. Make the most of this new freedom.

04

05

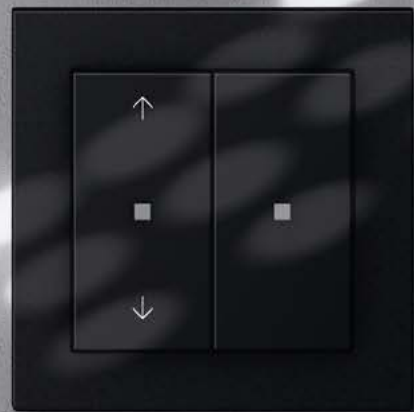

# The Smart Home system based on a 230 V installation: Gira KNX RF.

When existing single-family homes change hands or the old building is up for modernisation, owners increasingly want a Smart Home. It is also easy to upgrade existing KNX TP systems. With Gira KNX RF, you can plan and implement this quickly and easily.

## **230 V installation is sufficient.**

All that you need is a 230 V installation in the various rooms of the building. The new KNX RF operating top unit is then installed on the basis of Gira System 3000 inserts. A battery-operated KNX RF pushbutton sensor can be mounted on any walls without a power line. So the new KNX RF system can be installed in just a few steps.

Data security is guaranteed by the KNX Secure standard: the world's first security standard for smart buildings that is not tied to a specific manufacturer or application. This means that data integrity, authentication, encryption, and data currency are not a problem and the Smart Home is protected against unauthorised access.

Find out more about KNX RF in our explainer video



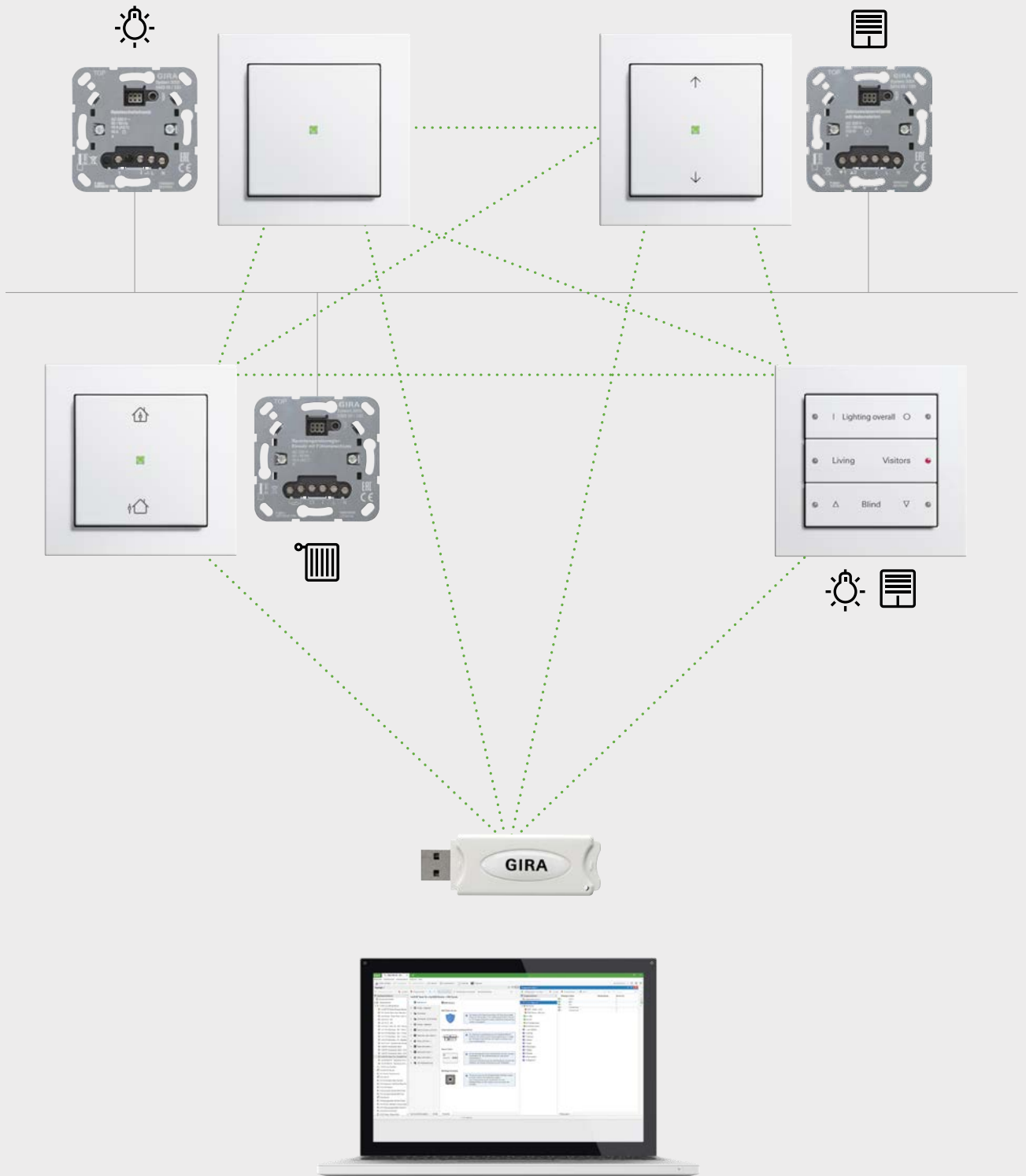

..... KNX RF connection  
— 230 V installation

# The new Gira KNX RF operating top unit for Gira System 3000.

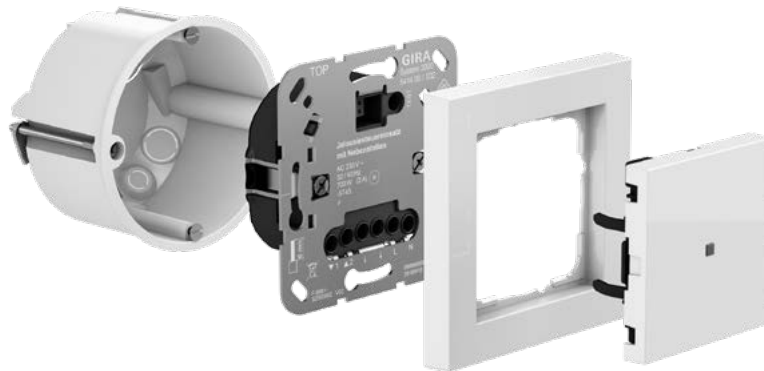

KNX RF operating top unit in combination with Gira System 3000 insert



KNX Secure enabled.  
[partner.gira.com/  
knx-secure](https://partner.gira.com/knx-secure)

Many functions for lighting, blind and heating control can be planned and installed as an integrated system with Gira System 3000.

The innovative Gira KNX RF operating top units are mounted on the Gira System 3000 inserts, enabling you to implement a Smart Home for your customers with little time and effort.

You can find more information about Gira System 3000 here







Easy to install: Gira KNX RF operating top unit



Gira KNX RF operating top unit – highlights, facts and benefits:

Lighting, blind and room temperature control.

Based on 230 V installation.

Efficient temperature control with integrated temperature sensor (depending on the Gira System 3000 insert used).

Wide range of functions thanks to Gira System 3000 inserts.

Extensive operating functions expand the areas of application.

Immediate function test possible (e.g. light on/off).

Efficient start-up via the ETS for implementing 2-way switches as well as central or group control.

Available in 1-gang and 2-gang variants.

Compatible with Gira System 55 and Gira F100.

# Added convenience for automation and visualisation.



The optional Gira X1 increases the KNX RF installation's built-in convenience with a server that makes it simple, handy, and economical to automate and visualise a single-family home with KNX RF. In combination with the KNX TP/RF media coupler, the Gira X1 controls the entire system.

The Gira Smart Home App update allows end customers to carry out extensive parameterisations themselves in the App.

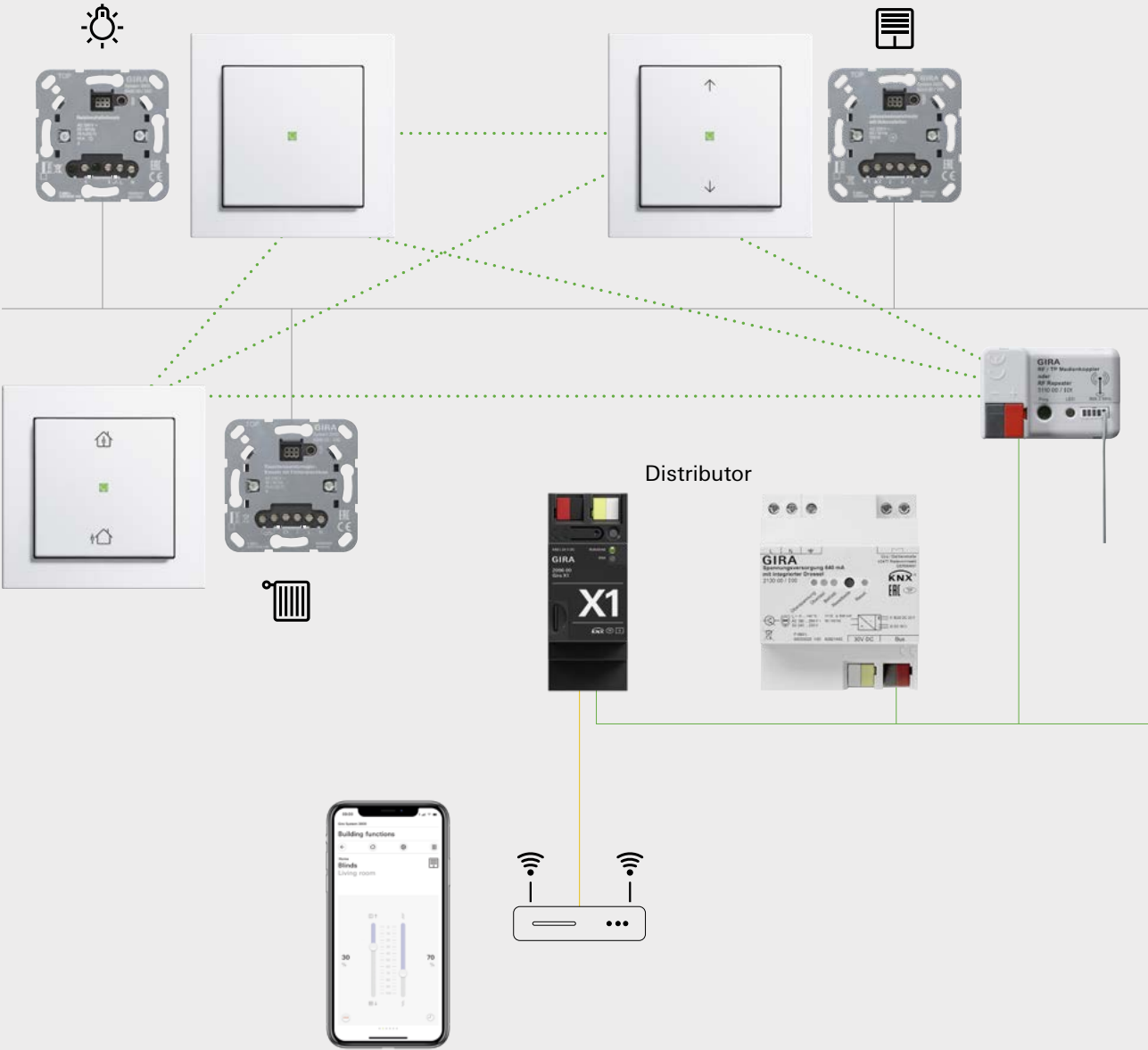

- ..... KNX RF connection
- \_\_\_\_\_ KNX TP line
- \_\_\_\_\_ 230 V installation
- \_\_\_\_\_ LAN

# Even more convenience with the Gira Smart Home App.



---

## Highlights, facts and benefits Gira Smart Home App (update):

---

End customers with admin rights can create scenes themselves, so tradesmen don't need to do these uneconomic jobs.

Philips Hue lights can be integrated independently by the end customer.

Overview page for all function timers that can be created and edited by the end customer.

Triggering of scenes via NFC tag by Senic Muse blocks.

Functions assignable to the desired subsection by the end customer.

Geodata set at the press of a button.

New users and administrators can be created by end customers with admin rights.

Creation of IoT switch by the end customer.

Parameterisation of various functions by end customers with admin rights.

Conflict detection for configured parameterisations by the Gira Project Assistant 4.7.

---

# Wireless and cable in a single system.

The Gira KNX RF/TP media coupler connects KNX RF devices with cable-connected KNX TP devices, enabling new or existing KNX TP installations to be extended to include KNX RF products. Via the Gira X1, for example.



Highlights, facts and benefits  
Gira KNX RF/TP media coupler:

---

Interface between wired KNX TP products  
and KNX RF wireless products.

Supports KNX Data Secure communication  
for filtering, forwarding, and blocking  
telegrams.

Fast communication between KNX  
products in main line and line.

---

  
TP installation

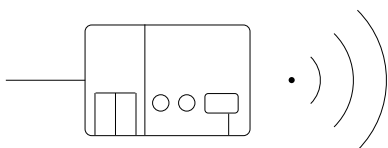

  
RF installation

---

## Convenient KNX RF system start-up.

The KNX RF system can also be started up with the ETS wirelessly via the Gira KNX RF data interface (USB stick). So you can now start up the system flexibly in the building rather than going to the control cabinet.



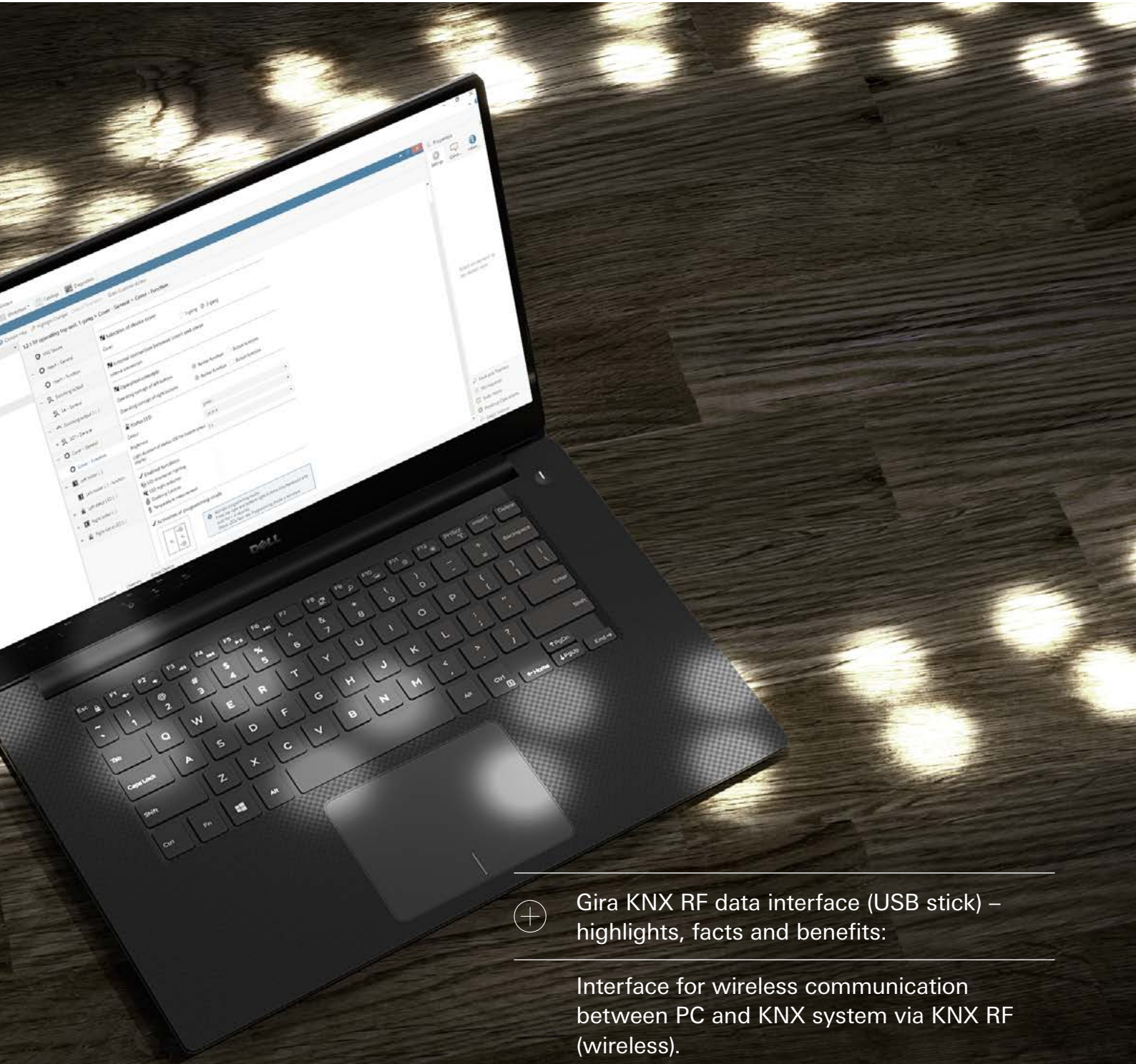

Gira KNX RF data interface (USB stick) – highlights, facts and benefits:

---

Interface for wireless communication between PC and KNX system via KNX RF (wireless).

KNX device addressing, programming and diagnostics by the start-up software from version ETS5.

Fast download of large applications through long frame support from ETS5.

Supports KNX Data Secure for the forwarding of encrypted telegrams.

---

## Battery-operated KNX RF operating devices.

The Gira KNX RF hand-held transmitter and the Gira KNX RF pushbutton sensor offer even more operating possibilities. As they are battery operated, they can be used very flexibly anywhere in the building.







The battery-operated Gira KNX RF pushbutton sensors can be placed as wireless wall transmitters in any location where operating elements are desired, regardless of the availability of power lines and bus cables: screwed to the wall, via a support ring on a flush-mounted device box, or with adhesive strips on smooth surfaces. The pushbutton sensors send out KNX telegrams that can be parameterised in many ways via the ETS.

For example

- for switching or using buttons
- for dimming
- for controlling blinds
- as a value transmitter
- as a scene auxiliary unit

The battery-operated Gira KNX RF hand-held transmitters make control mobile, as the desired KNX function can be conveniently activated by remote control from any point in the building. The hand-held transmitters send KNX telegrams wirelessly when the buttons are pressed, depending on the parameter setting when the application program is loaded.

For example

- for switching or using buttons
- for dimming
- for controlling blinds

# Classically wired – innovations for KNX TP installation.

The new Gira KNX TP solutions will help you meet even the most demanding requests from your customers and allows you to interlink lighting, blind, and heating control together with multimedia and security components in a single smart system – also in combination with KNX RF components.

---

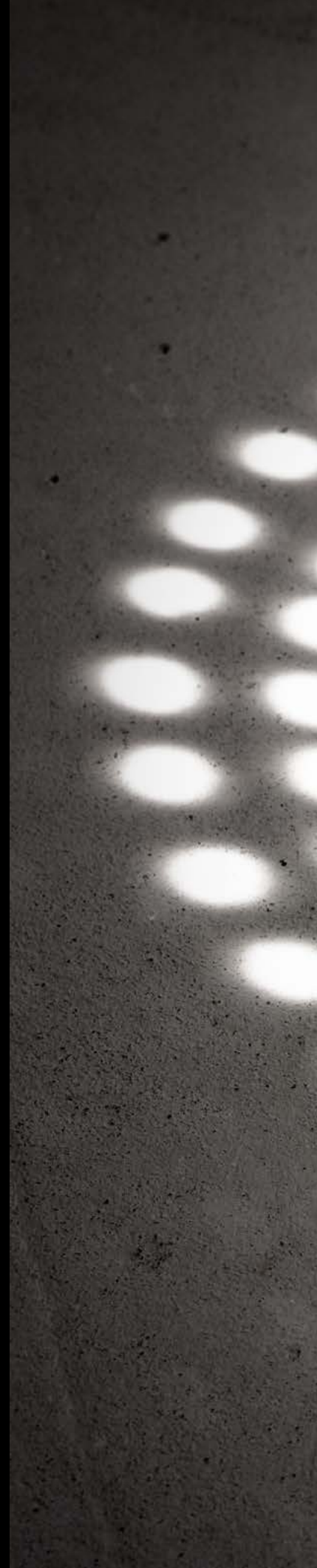



# Safe – and versatile!



The three new KNX flush-mounted actuators for lighting and blinds are particularly suitable for supplementing existing KNX installations. Among other things, decentralised use reduces the amount of cabling required and the fire load in the installation.

- 01 Switching actuator, 2-gang/  
blind actuator, 1-gang
- 02 Switching actuator, 1-gang
- 03 Dimming actuator, 1-gang



KNX Secure enabled.  
[partner.gira.com/  
knx-secure](https://partner.gira.com/knx-secure)



---

Highlights, facts and benefits  
Gira KNX flush-mounted actuators:

---

Supplement existing installations, e.g. in parapet ducts of large buildings.

Close planning gaps in new buildings.

Retrofitting for major renovations.

Decentralised installation possible at the point of use.

Three binary inputs for connecting conventional buttons, window contacts, and Gira dew and leakage sensors.

Breakout cable for KNX, binary inputs and screw terminals on the load side.

Can be updated via the Gira ETS Service App.

---

A wide range of KNX functions can be implemented with the Gira KNX switching/blind actuator. Depending on the design, up to 24 channels are available and can be used as required for switching and blind functions.



KNX Secure enabled.  
[partner.gira.com/  
 knx-secure](http://partner.gira.com/KNX-secure)



Highlights, facts and benefits  
 Gira KNX switching/blind actuator:

Spacious terminal compartment with high-quality terminals.

Available as a Standard or Komfort variant.

Available in 3/6-gang, 8/16-gang, or 12/24-gang versions.

Maximum encryption and data protection standards with KNX Secure technology.

Clear ETS product database with context help.

Can be updated via the Gira ETS Service App.

The Gira KNX dimming actuator 4-gang provides a total of four outputs for the separate control of lighting circuits of up to 225 W each in a compact design of only four modular widths.

The new products are particularly suitable for controlling modern high-voltage LEDs, enabling dimming of up to 200 W per output.



KNX Secure enabled.  
[partner.gira.com/  
 knx-secure](http://partner.gira.com/KNX-secure)



Highlights, facts and benefits  
 Gira KNX dimming actuator:

Spacious terminal compartment with high-quality terminals.

Optimised for high-voltage LEDs.

Available as a Standard or Komfort variant.

Maximum encryption and data protection standards with KNX Secure technology.

Clear ETS product database with context help.

Can be updated via the Gira ETS Service App.

# Customised control of the Smart Home.



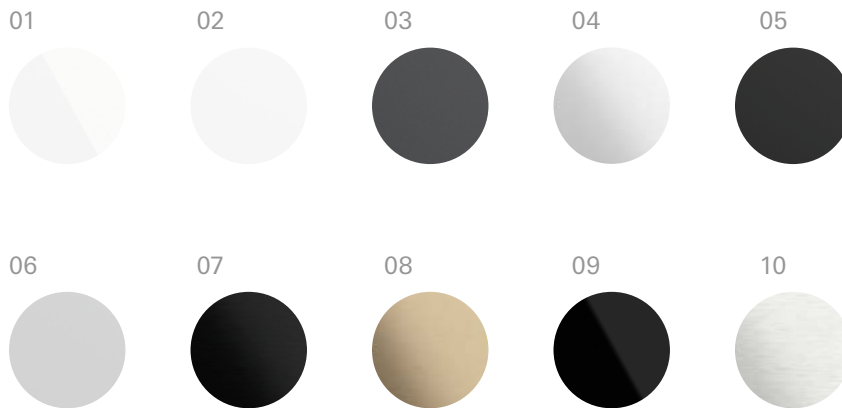

The minimalist and elegant surface of the Gira pushbutton sensor 4 conceals smart technology that your customer can use to control numerous blinds, lights and scenes in their KNX system. The pushbutton sensor is available with one, two, or four rockers, to which up to eight functions can be assigned.

Colour variants:

- 01 Pure white glossy (lacquered)
- 02 Pure white matt (lacquered)
- 03 Anthracite (lacquered)
- 04 Aluminium
- 05 Black matt (lacquered)
- 06 Grey matt (lacquered)
- 07 Aluminium black
- 08 Bronze
- 09 Black glass
- 10 Stainless steel



#### Highlights, facts and benefits Gira pushbutton sensor 4:

---

High-quality, modern, and award-winning design.

Large operating surface, excellent feel and high-quality appearance thanks to 3 mm thick material overlay.

Integrated temperature and humidity sensor.

Wide range of materials and colours available.

Multi-coloured LEDs (RGBW) for status display.

Can be updated via the Gira ETS Service App.

---



# Gira Academy. Knowledge provides security – and pays off.

We don't expect you to get to grip with technical innovations on your own. That's why we offer various types of training for the Gira KNX RF product world in the Gira Academy. So that your introduction to the wireless KNX world is as easy as possible.

## Online seminar.

Discover Gira KNX RF in an online seminar with a direct facilitator in a virtual room. Questions that arise can be clarified immediately through exchanges with the other participants.



### Help with your day-to-day work.

As a partner in the electrical trade, you can count on us to provide comprehensive support whenever you need it – from planning and ordering to professional help with commissioning and servicing.

### Online catalogue.

Discover the complete Gira product range, from switches to intelligent system solutions. The Gira online catalogue has a range of useful features. You can manage parts lists, compare products, and use the intelligent search.

All products in the  
online catalogue at  
[catalogue.gira.com](http://catalogue.gira.com)



### Web-based training.

Get to know the basics of Gira KNX RF: Gira's web-based training course for Gira System 3000 shows you how Gira System 3000 works with the Gira KNX RF operating top unit and the possibilities offered by combining the two.

You can find out  
more about the  
training courses  
we offer at  
[academy.gira.com](http://academy.gira.com)



# Being innovative means thinking beyond your own four walls.

Since 1905, we've been the ones with switches, but we're so much more ... Because innovations are our great passion. Our pioneering spirit drives us to constantly improve and enhance the comfort of people's homes with innovative solutions.



"Made by Diversity".

Gira has been manufacturing products at its location in Radevormwald for more than 100 years. The company is fully committed to the "Made in Germany" quality standard. This is what 1,250 employees from 27 nations work for – each and every one of them with different talents, individual expertise, wide-ranging experiences, and different life stories. This diversity – supported by common values – is the basis for our creativity, innovative strength, and viability for the future.

Innovative technology,  
award-winning design.

We have always strived to combine maximum functionality and reliability with a unique design to create special user experiences. The extraordinary design quality and functionality of our products have been recognised by many internationally acclaimed awards.



GERMAN  
INNOVATION  
AWARD 20  
WINNER



DESIGN  
AWARD



GERMAN  
DESIGN  
AWARD  
WINNER  
2022



ICD  
2022  
INNOVATIVE  
INTERIOR  
best of best



ARCHITECTS' DARLING  
AWARDS 2021  
GOLD  
Heinze



reddot winner 2020  
best of the best

Published by:

Gira Giersiepen GmbH & Co. KG

Picture credits:

Interface design:

Pages 11, 12

schmitz Visuelle Kommunikation

hgschmitz.de

Subject to technical modifications.

Any colour variations between the images in this product information and the product are due to printing processes and cannot be avoided.

Shaping the future also means doing everything possible to protect the environment in which we want to live in the future. When creating this brochure, Gira supported the idea of sustainability by handling resources responsibly and using environmentally sound materials. The paper used is FSC® certified and is made of at least 60% recycled paper.

[www.sustainability.gira.com](http://www.sustainability.gira.com)



# GIRA

Gira  
Giersiepen GmbH & Co. KG  
Electrical installation systems

Industriegebiet Mermbach  
Dahlienstraße  
42477 Radevormwald

P.O. Box 12 20  
42461 Radevormwald  
Germany

Phone +49 2195 602-0  
Fax +49 2195 602-119

[www.gira.com](http://www.gira.com)  
[info@gira.com](mailto:info@gira.com)

---

Order no. 19820 90 02/22 1. 22